



Cavi industriali
Industrial cables

www.tekima.com

ITA/ENG



Un Grazie di cuore a tutti i nostri collaboratori.

Con il loro impegno quotidiano contribuiscono al successo di Tekima, un'eccellenza nel mercato italiano ed internazionale, ricordandoci che il prodotto, sebbene eccezionale, deve essere spiegato con competenza e passione, tagliato, imballato, spedito prontamente e consegnato in orario.

Grazie a loro ed a chi, insieme a noi, reinterpreta il proprio lavoro come una missione quotidiana con l'obiettivo di eccellere e fare sempre meglio di ieri.

Massimo Ceolaro

Alessandro Giovannini

A heartfelt thanks to all our colleagues.

With their daily commitment contributing to Tekima's success, an excellence in the Italian and international markets, reminding us that the product, although excellent, must be explained with competence and passion, cut, packed, shipped promptly and delivered on time.

Thanks to them and to those whom, together with us, reinterpret their own work as a daily mission with the aim of excelling and always do better than the day before.

Scopri il nostro Team



Discover our Team



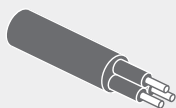

Cavi industriali

Cavi unipolari
Cavi multipolari per posa fissa
Cavi multipolari per posa mobile
Cavi per trasmissione dati
Cavi multipolari "Hybrid"
Cavi "Made in USA"
Cavi connessi "Contek"
Pressacavi, raccordi e sistemi passacavo

Industrial cables

Single core cables
Cables for fixed application
Cables for dynamic applications
Data transmission cables
Multi-conductor "Hybrid" cables
"Made in USA" Listed cables
"Contek" Connectorized cables
Fittings and cable entry systems

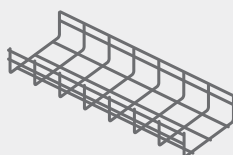

Componenti per il bordo macchina

Interfacce, prese, spine
Indicatori e stazioni di verifica tensione
Relè di protezione dell'arco elettrico
Sistemi di illuminazione
Guaine corrugate
Guaine rinforzate
Tubazioni metalliche rigide
Sistemi di canaline
Fusibili e portafusibili
Pittogrammi di sicurezza

Field-installed components

Panel interface, plugs, receptacles
Voltage indicators and voltage test stations
Arc-Flash Relays
Cabinet lights and luminaires
Corrugated conduits
Reinforced conduits
Rigid metal tubings and conduits
Cable tray systems
Fuses and fuseholders
Safety labels



Prodotti di cablaggio

Fascette di cablaggio
Guaine termorestringenti
Guaine termorestringenti con adesivo
Guaine termorestringenti per alte temperature
Preformati termorestringenti
Guaine non termorestringenti

Wiring and cabling systems

Cable ties
Heat shrinkable tubings
Heat shrinkable tubings with adhesive
High-temperature heat shrinkable tubings
Heat shrinkable molded shapes
Non-shrinkable tubings

Solvtek è l'applicativo web per calcolare:

- la caduta di tensione
- la lunghezza massima
- il carico massimo
- le dimensioni dei conduttori
- il diametro del fascio di cavi
- le dimensioni della guaina termorestringente più adatta
- la taglia della tubazione (raceways) o della canalina (cable trays)
- la distanza dei supporti

ed infine, è possibile validare i **sistemi a sicurezza intrinseca**.

Solvtek semplifica l'attività di studi tecnici e progettisti

fornendo metodi di calcolo basati sui principali standard e sulle diverse edizioni normative.

Queste sono alcune delle utilities dedicate ai prodotti contenuti in questo catalogo.

Solvtek is the web application with which it is possible to calculate:

- the voltage drop of the conductor
- the maximum length of the conductor
- the maximum load of the conductor
- the sizes of the conductors
- the diameter of the cables' bundle
- the dimensions of the most suitable heat shrink tubing
- the size of the raceways or the cable trays
- the distance of the supports

and finally, it is possible to validate intrinsically safe systems.

Solvtek simplifies the work of technical offices and designers

by providing calculation methods based on the main standards and on the various regulatory editions.

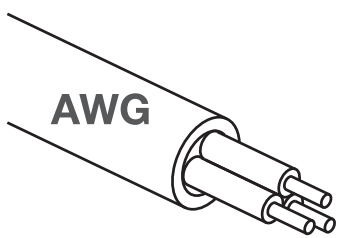
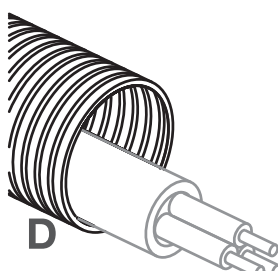
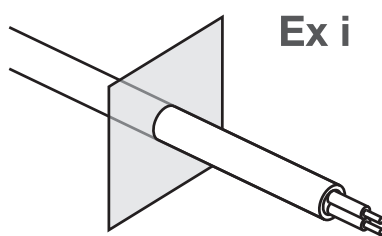

These are some of the utilities.

<p>Calcolo della sezione del conduttore e del carico massimo applicabile secondo le norme NFPA 79, NFPA 70 (NEC), CSA C22.1 (CE Code), UL 2011.</p> <p>Calculation of the conductor size and the maximum load applicable according to the NFPA 79, NFPA 70 (NEC), CSA C22.1 (CE Code), UL 2011 standards.</p>	<p>Dimensionamento della canalina (cable trays) in funzione dei requisiti della norma NFPA 70 (NEC).</p> <p>Sizing of the rigid or flexible tubing, metallic and non-metallic according to the requirements of the NFPA 70 (NEC) and NFPA 79 standards</p>	<p>Validazione del sistema a sicurezza intrinseca secondo i requisiti delle norme EN 60079 e ANSI/UL 60079.</p> <p>Validation of the intrinsically safe system according to the requirements of EN 60079 e ANSI/UL 60079 standards</p>
		













Indice

Index









Cavi unipolari - Single core cables

Serie Series	Prodotto Product	Pagina Page	Isolamento Insulation	Guaina Jacket	Tensione nominale Voltage rating	Temperatura di esercizio Temperature rating	Certificazioni USA Canada USA and Canada Certification	Posa Use
N0000	Trecce tonde flessibili in rame rosso e in rame stagnato <i>Bare or tinned flexible copper braids</i>	24	-	-	-	-	-	Fissa <i>Fixed</i>
900	Cavi unipolari Style 1569/1007 <i>Single core cables Style 1569/1007</i>	25	PVC	-	300 V	-40°C +80°C/+105°C		Fissa <i>Fixed</i>
910	Cavi unipolari Style 1015/1284 <i>Single core cables style 1015/1284</i>	26	PVC	-	600 V	-40°C, +105°C		Fissa <i>Fixed</i>
911	Cavi unipolari Style 1015 <i>Single core cables style 1015</i>	27	PVC	-	600 V 450/750V	-40°C +70°C/+90°C/+105°C		Fissa <i>Fixed</i>
950	Cavi unipolari in silicone e fibra di vetro <i>Silicone rubber braided glass cables</i>	29	Silicone	Fibra di vetro <i>Glass fiber</i>	600 V	+150°C/+200°C		Fissa <i>Fixed</i>
960 960S	Cavi unipolari altamente flessibili per posa mobile <i>High flexible single core cables for dynamic application</i>	31	PVC	PUR	600/1000 V 600 V	-40°C/-5°C +80°C/+90°C		300 m/min 30 m/s ²
1000	Cavi unipolari tipo THHN MTW <i>Single core cables type THHN MTW</i>	35	PVC	Nylon	600 V	+90°C		Fissa <i>Fixed</i>
1010S	Cavi unipolari XHHW-2 <i>Single core cables type XHHW-2</i>	37	XLPE	PVC	600/1000 V 600 V	-40°C/-15°C +90°C		Fissa <i>Fixed</i>
1050 1050S	Cavi unipolari Style 1032 <i>Single core cables Style 1032</i>	39	PVC	PVC	600/1000 V 1000 V	-40°C/-5°C +90°C		Fissa <i>Fixed</i>
1060	Cavi unipolari tipo THHW/TFF MTW <i>Single core cables type THHW/TFF MTW</i>	41	PVC	-	600 V 450/750 V	-40°C/-5°C, +70°C/+90°C		Fissa <i>Fixed</i>
1070	Cavi unipolari tipo THHW/TFF MTW AWM TEW <i>Single core cables type THHW/TFF MTW AWM TEW</i>	43	PVC	-	450/750V 600V 1000V	-40°C/-5°C, +70°C/+90°C/+105°C		Fissa <i>Fixed</i>
1075	Cavi unipolari tipo THHW MTW AWM TEW per posa mobile <i>Single core cables type THHW MTW AWM TEW for dynamic applications</i>	45	PVC	-	450/750V 600V 1000V	-40°C/-5°C, +70°C/+90°C/+105°C		180 m/min 20 m/s ²



















Cavi multipolari per posa fissa - Cables for fixed applications

Serie Series	Prodotto Product	Pagina Page	Isolamento Insulation	Guaina Jacket	Tensione nominale Voltage rating	Temperatura di esercizio Temperature rating	Certificazioni USA Canada USA and Canada Certification	Posa Use
50 50S	Cavi "LiYY" e "LiYCY" per trasmissione dati <i>"LiYY" and "LiYCY" data transmission cables</i>	50	PVC	PVC	300/500 V	-40°C/-5°C +70°C/+80°C		Fissa <i>Fixed</i>
100 100S	Cavi multipolari "Flextek" antiolio e UV resistant altamente flessibili <i>"Flextek" high flexible oil-resistant and UV-resistant cables</i>	54	PVC	PVC	450/750 V	-40°C/-5°C +70°C/+80°C		Fissa <i>Fixed</i>
100 100S	Cavi multipolari "Flextek Hybrid Black" antiolio e UV resistant altamente flessibili <i>"Flextek Hybrid Black" high flexible oil-resistant and UV-resistant cables</i>	61	PVC	PVC	450/750 V	-40°C/-5°C +70°C/+80°C		Fissa <i>Fixed</i>
105 105S	Cavi multipolari "Flextek-B" antiolio e UV resistant <i>"Flextek-B" oil-resistant and UV-resistant cables</i>	63	PVC	PVC	600/1000 V	-40°C/-5°C +70°C/+80°C		Fissa <i>Fixed</i>
150 150S 151	Cavi multipolari armati "Armatek" antiolio <i>"Armatek" armoured oil-resistant cables</i>	67	PVC	PVC	300/500 V 600/1000 V	-40°C/-5°C +70°C/+80°C		Fissa <i>Fixed</i>
200 200S	Cavi multipolari "Flextek-PUR" antiolio ad alte prestazioni <i>"Flextek-PUR" oil-resistant high performing cables</i>	75	PVC	PUR	300/500 V	-40°C/-15°C		Fissa <i>Fixed</i>
345 345S	Cavi multipolari multinorma antiolio <i>Multi-norm oil-resistant cables</i>	79	PVC	PVC	300/500 V 450/750 V 1000 V	-40°C/-5°C +90°C		Fissa <i>Fixed</i>
361S	Cavi VFD 3xG a bassa capacità, AWM <i>Low capacity VFD 3xG cables, AWM</i>	85	TKblend®-YP	PVC	600 V 600/1000 V	40°C/-5°C +90°C		Fissa <i>Fixed</i>
361S	Cavi VFD 1xG a bassa capacità, AWM <i>Low capacity VFD 1xG cables, AWM</i>	87	TKblend®-YP	PVC	600 V 600/1000 V	40°C/-5°C +90°C		Fissa <i>Fixed</i>
365S	Cavi VFD 3xG a bassa capacità, TC-ER/CIC/MTW/WTTC, Direct Burial, Sun Res <i>Low capacity VFD 3xG cables, TC-ER/CIC/MTW/WTTC, Direct Burial, Sun Res</i>	89	Special XLPE	PVC	600V 1000 V 600/1000V	-40°C/-5°C +90°C	 	Fissa <i>Fixed</i>
365S	Cavi VFD 1xG a bassa capacità, TC-ER/CIC/MTW/WTTC, Direct Burial, Sun Res <i>Low capacity VFD 1xG cables, TC-ER/CIC/MTW/WTTC, Direct Burial, Sun Res</i>	91	Special XLPE	PVC	600V 1000 V 600/1000V	-40°C/-5°C +90°C	 	Fissa <i>Fixed</i>
365S	Cavi VFD 1xG+1xP a bassa capacità, TC-ER/CIC/MTW/WTTC, Direct Burial, Sun Res <i>Low capacity VFD 1xG+1xP cables, TC-ER/CIC/MTW/WTTC, Direct Burial, Sun Res</i>	93	Special XLPE	PVC	600V 1000 V 600/1000V	-40°C/-5°C +90°C	 	Fissa <i>Fixed</i>
370S	Cavi multipolari a sicurezza intrinseca <i>Intrinsically safe cables</i>	95	TKblend®-R	PVC	300 V 300/500 V	-25°C/-5°C +80°C		Fissa <i>Fixed</i>
380 380S	Cavi multipolari multinorma in silicone per alta temperatura <i>High temperature multi-norm silicone cables</i>	96	Silicone	Silicone	450/750 V 600 V	-60°C +150°C/+180°C		Fissa <i>Fixed</i>
8110 8110S	Power and Control Tray Cable, TC-ER-HL/CIC/MTW/WTTC/AWM Direct Burial, Sun Res	100	TKblend®-R	PVC	600 V 1000 V 600/1000 V	-40°C/-5°C, +75°C/+90°C	 	Fissa <i>Fixed</i>

Cavi multipolari per posa mobile - Cables for dynamic applications

Serie Series	Prodotto Product	Pagina Page	Isolamento Insulation	Guaina Jacket	Tensione nominale Voltage rating	Temperatura di esercizio Temperature rating	Certificazioni USA Canada USA and Canada Certification	Posa Use
8410 8410S	Power and Control Tray Cable, TC-ER/CIC/MTW/WTTC/AWM	106	TKblend®-R	PVC	600 V 1000 V 600/1000 V	-40°C/-5°C, +75°C/+90°C		180 m/min 10 m/s ²
400S	Cavi multipolari multinorma antiolio per servomotori <i>Multi-norm oil-resistant cables for servo motors</i>	110	TKblend®-YP	PVC	600/1000V 1000V	-40°C/-5°C +80°C		180 m/min 3 m/s ²
410 410S	Cavi multipolari multinorma antiolio <i>Multi-norm oil-resistant cables</i>	112	PVC	PVC	300/500 V 600 V	-40°C/-0°C +90°C		180 m/min 3 m/s ²
440 440S	Cavi multipolari multinorma antiolio <i>Multi-norm oil-resistant cables</i>	116	TKblend®-L	PVC	300 V 300/500 V 600/1000 V 1000 V	-30°C/-5°C +80°C		180 m/min 7 m/s ²
440S	Cavi multipolari multinorma antiolio per servomotori <i>Multi-norm oil-resistant cables for servo motors</i>	122	TKblend®-L	PVC	600/1000 V 1000 V	-30°C/-5°C +80°C		180 m/min 7 m/s ²
600 600S	Cavi multipolari multinorma antiolio altamente flessibili <i>Multi-norm oil-resistant high flexible cables</i>	124	TKblend®-L	PUR	300 V 300/500 V 600/1000 V 1000 V	-40°C/-30°C +80°C		>220 m/min 10 m/s ²
600S	Cavi multipolari multinorma antiolio altamente flessibili per servomotori <i>Multi-norm oil-resistant high flexible cables for servo motors</i>	130	TKblend®-L	PUR	600/1000 V 1000 V	-40°C/-30°C +80°C		>220 m/min 10 m/s ²
600S	Cavi multipolari multinorma antiolio altamente flessibili per encoder e resolver <i>Multi-norm oil-resistant high flexible cables for encoders and resolvers</i>	132	TKblend®-L	PUR	300 V 300/500 V	-40°C/-30°C +80°C		>220 m/min 10 m/s ²







Cavi per trasmissione dati - Data transmission cables

Serie Series	Prodotto Product	Pagina Page	Isolamento Insulation	Guaina Jacket	Tensione nominale Voltage rating	Temperatura di esercizio Temperature rating	Certificazioni USA Canada USA and Canada Certification	Posa Use
71000	Cavi per trasmissione dati Profibus <i>Profibus data communication cables</i>	136	TKblend®-L	PVC	300 V	-10°C, +80°C		Fissa <i>Fixed</i>
71100	Cavi per trasmissione dati Profibus <i>Profibus data communication cables</i>	137	TKblend®-L	PVC	30 V	-10°C, +80°C		80 m/min 7 m/s ²
71140	Cavi per trasmissione dati Profibus ad alte prestazioni <i>High performances Profibus data communication cables</i>	138	TKblend®-L	PUR	300 V	-10°C, +80°C		180 m/min 3 m/s ²
71600	Cavo per trasmissione dati Profibus CMX ad alte prestazioni <i>High performances Profibus CMX data communication cables</i>	139	TKblend®-L	PUR	300 V	-40°C/-30°C +70°C/+75°C		180 m/min 3 m/s ²
73000	Cavi per trasmissione dati DeviceNet <i>DeviceNet data communication cables</i>	140	TKblend®-L	PVC	300 V	-40°C, +80°C		Fissa <i>Fixed</i>
73100	Cavi per trasmissione dati DeviceNet <i>DeviceNet data communication cables</i>	141	TKblend®-L	PUR	300 V	-40°C, +80°C		180 m/min 5 m/s ²
74100	Cavi per trasmissione dati CanOpen <i>CanOpen data communication cables</i>	142	TKblend®-L	PVC	300 V	-40°C, +80°C		Fissa <i>Fixed</i>
74000	Cavi per trasmissione dati CanOpen <i>CanOpen data communication cables</i>	143	TKblend®-L	PUR	300 V	-40°C, +80°C		180 m/min 5 m/s ²
75000	Cavi per trasmissione dati Ethernet industriale <i>Industrial Ethernet data transmission cables</i>	144	TKblend®-L	PVC	300 V	-30°C, +80°C		Fissa <i>Fixed</i>
75500	Cavo per trasmissione dati Ethernet industriale CMR <i>Industrial Ethernet CMR data communication cables</i>	145	TKblend®-L	PVC	125 V	-30°C, +75°C		Fissa <i>Fixed</i>
75100	Cavi per trasmissione dati Ethernet industriale <i>Industrial Ethernet data transmission cables</i>	146	TKblend®-L	TPE/PUR	125 V	-40°C, +80°C		180 m/min 3 m/s ²
75200	Cavi per trasmissione dati Ethernet industriale Cat. 6 <i>Industrial Ethernet data transmission cables Cat. 6</i>	147	TKblend®-L	PUR	1000 V (work 50 V)	-40°C/-30°C +80°C		300 m/min 5 m/s ²
75600	Cavo per trasmissione dati Ethernet Industriale CMX <i>Industrial Ethernet CMX data communication cables</i>	148	TKblend®-L	PUR	125 V	-30°C/-40°C, +70°C/+75°C		180 m/min 3 m/s ²
75700	Cavo per trasmissione dati Ethernet Industriale CMX Cat.6 <i>Industrial Ethernet CMX data communication cables Cat.6</i>	149	TKblend®-L	PUR	300 V (work 50 V)	-40°C/-20°C +75°C/+80°C		300 m/min 5 m/s ²
77000	Cavi per trasmissione dati Profinet <i>Profinet data transmission cables</i>	150	TKblend®-L	PVC	300 V	-30°C, +80°C		Fissa <i>Fixed</i>
77100	Cavi per trasmissione dati Profinet <i>Profinet data transmission cables</i>	151	TKblend®-L	TPE/PUR	300 V	-40°C/-20°C +60°C/+80°C		180 m/min 5 m/s ²
78000	Cavi per trasmissione dati tipo DRIVE-CLiQ <i>DRIVE-CLiQ data transmission cables</i>	152	TKblend®-YP	PUR	300 V	-50°C/-25°C +80°C		Fissa <i>Fixed</i>
78100	Cavi per trasmissione dati tipo DRIVE-CLiQ <i>DRIVE-CLiQ data transmission cables</i>	153	TKblend®-YP	PUR	300 V	-50°C/-25°C/+5°C +60°C/+80°C		220 m/min 10 m/s ²
DATA	Cavi per encoder, resolver e trasmissione dati <i>Encoder, resolver and data transmission cables</i>	154	Vari <i>Various</i>	Vari <i>Various</i>	Vari <i>Various</i>	Vari <i>Various</i>		Fissa <i>Fixed</i>

Cavi multipolari “Hybrid” - Multi-conductor “Hybrid” cables

Serie Series	Prodotto Product	Pagina Page	Isolamento Insulation	Guaina Jacket	Tensione nominale Voltage rating	Temperatura di esercizio Temperature rating	Certificazioni USA Canada USA and Canada Certification	Posa Use
HYBRID	Cavi multipolari “Hybrid” Multi-conductor “Hybrid” cables	160			Vari Various			

















Cavi “Made in USA” - “Made in USA” cables

Serie Series	Prodotto Product	Pagina Page	Isolamento Insulation	Guaina Jacket	Tensione nominale Voltage rating	Temperatura di esercizio Temperature rating	Certificazioni USA Canada USA and Canada Certification	Posa Use
80010 80020	Flexible cord type S e SJ	164	Termodurente Thermoset	Termodurente Thermoset	300 V 600 V	-40°C, +60°C	 	
80140 80160	Flexible cord type SJOOW	166	Termodurente Thermoset	Termodurente Thermoset	300 V	-40°C, +90°C/+105°C	 	
80080	Flexible cord type STOW	167	PVC	PVC	600 V	-40°C, +90°C	 	
80060	Flexible cord type SJTOW	169	PVC	PVC	300 V	-40°C, +90°C	 	
80050	Flexible cord type SJT	171	PVC	PVC	300 V	-20°C, +60°C	 	
80120 8012S	Flexible cord type SOOW	172	Termodurente Thermoset	Termodurente Thermoset	600 V	-40°C, +90°C	 	
80130	Flexible cord type W	175	Termodurente Thermoset	Termodurente Thermoset	2000 V	-40°C, +90°C	 	
80150 80155	Flexible cord type G e G-GC	178	Termodurente Thermoset	Termodurente Thermoset	2000 V	-40°C, +90°C	 	
20070	Festoon Cable Neoprene	180	Termodurente Thermoset	Neoprene	600 V	-50°C, +90°C	 	
20020 2002S	Festoon Cable PVC	182	PVC	PVC	600 V	-10°C, +105°C	 	
8100 8100S	Power and Control Tray Cable TC-ER	184	PVC/Nylon	PVC	600 V	+75°C/+90°C		
8150S	Power-limited Tray Cable PLTC/ITC	189	PVC	PVC	300 V	+105°C		
8200 8200S	Metal-Clad Cable MC-HL	190	XLPE PVC/Nylon	PVC	600 V	+90°C		
8250	Metal-Clad Cable Teck 90-HL	194	XLPE	PVC	600 V	+90°C		

Cavi connettorizzati "Contek"- "Contek" connectorized cables

Serie Series	Prodotto Product	Pagina Page	Isolamento Insulation	Guaina Jacket	Tensione nominale Voltage rating	Temperatura di esercizio Temperature rating	Certificazioni USA Canada USA and Canada Certification	Posa Use
CONTEK	Cavi connettorizzati "Contek" "Contek" connectorized cables	198				Vari Various		

Raccordi e sistemi passacavo - Fittings and cable entry systems

Prodotto Product	Pagina Page	Materiale Material	Materiale guarnizione di tenuta Sealing material	Temperatura di esercizio Temperature rating	Grado di protezione Protection class	Certificazioni USA Canada USA and Canada Certification
Pressacavi sintetici Synthetic cable glands	202	Poliammide PA 6 Polyamide PA 6	TPE/CR (Neoprene)	-30°C +100°C	IP 68	 
Pressacavi metallici Metallic cable glands	206	Ottone nichelato Nickel-plated brass	TPE, NBR	-40°C +100°C	IP 68	
Pressacavi metallici NEMA NEMA metallic cable glands	210	Ottone nichelato o acciaio inossidabile Nickel-plated brass or Stainless steel	EPDM	-45°C +105°C	IP 68 NEMA 4X	  
Pressacavi metallici ad alte prestazioni High-performing metallic cable glands	212	Ottone nichelato Nickel-plated brass	TPE, NBR	-40°C +100°C	IP 68 (10 bar) IP 69K	 
Pressacavi metallici compatibili EMC ad alte prestazioni High-performing EMC-compatible metallic cable glands	215	Ottone nichelato Nickel-plated brass	TPE	-60°C +100°C	IP 68 (10 bar) IP 69K	
Pressacavi metallici ultra piatti ad alte prestazioni High-performing ultra-flat metallic cable glands	218	Ottone nichelato o Acciaio inossidabile Nickel-plated brass or Stainless steel	TPE/FKM, FPM/FKM	-40°C +100°C/+200°C	IP 68 (10 bar) IP 69K	
Bilanciatori di pressione a membrana Pressure balance with membrane	220	Poliammide PA 6 o Ottone nichelato Polyamide PA 6 or Nickel-plated brass	NBR	-40°C +100°C/+110°C	IP 66 IP 68 IP 69K	
Bilanciatori di pressione con filtro sinterizzato Pressure balance with sintered filter	222	Ottone nichelato Nickel-plated brass	NBR	-50°C +110°C	IP 54 IP x9K	
Elemento di drenaggio Drainage element	223	Ottone nichelato Nickel-plated brass	NBR	-50°C +110°C	IP 4x	
Raccordi per cavi MC-HL e Teck 90-HL Fittings for MC-HL and Teck90-HL cables	225	Alluminio o Ottone Aluminum or Brass	Resina Resin	-25°C +60°C	NEMA 4 IP 56	 
Sistemi passacavo preconfigurati Preconfigured cable entry systems	227	Poliammide PA 6 Polyamide PA 6	TPU/NBR/EPDM	-30°C +70°C	IP 54 IP 65	 
Sistemi passacavo componibili Configurable cable entry systems	234	Poliammide PA 6 Polyamide PA 6	-	-40°C +80°C	IP 54	 
Elementi per sistemi passacavo Grommets for cable entry system	238	-	Gomma termoplastica Thermoplastic rubber	-40°C +80°C	IP 54	 

Appendice - Appendix

	Pagina Page		Pagina Page
Appendice A. Conduttori elettrici, sezioni e diametri <i>Appendix A. Wires, Sizes and AWG diameters</i>	242	Appendice L. Hazardous locations <i>Appendix L. Hazardous locations</i>	351
A.1 Misura dei conduttori elettrici, sezioni e diametri <i>A.1 AWG and kcmil wires' sizes measurement</i>	242	Appendice M. Test di resistenza al fuoco per cavi e conduttori <i>Appendix M. Cables and wires' flame resistance tests</i>	355
A.2 Conduttori elettrici secondo EN 60228 <i>A.2 Wires according to EN 60228</i>	244	Appendice N. Classi di infiammabilità per materie plastiche <i>Appendix N. Flammability rating for plastic materials</i>	360
A.3 Correlazione tra le sezioni dei conduttori in AWG e IEC <i>A.3 Wires, correlations between AWG and IEC Sizes</i>	247	Appendice O. Trasporto, immagazzinamento e impiego dei cavi <i>Appendix O. Cables' transportation, storage and handling</i>	362
A.4 Sezioni minime dei conduttori secondo EN 60204-1 <i>A.4 Minimum cross-Sizeal areas of copper conductors according to EN 60204-1</i>	248	0.1 Trasporto e immagazzinamento <i>0.1 Transportation and storage</i>	362
Appendice B. Portate dei conduttori <i>Appendix B. Wire capacity</i>	249	0.2 Impiego <i>0.2 Handling</i>	363
B.1 Portate dei conduttori secondo UL 508a <i>B.1 Wires ampacities according to UL 508a</i>	249	0.3 Impiego dei cavi in catena portacavi <i>0.3 Use of cables in drag-chain</i>	364
B.2 Portate dei conduttori secondo CSA C22.2 No. 286 <i>B.2 Ampacity of conductors according to CSA C22.2 No. 286</i>	252	Appendice P. Tabelle colore <i>Appendix P. Tables of Color</i>	366
B.3 Portate dei conduttori secondo NFPA 79 <i>B.3 Ampacities of conductors according to NFPA 79</i>	253	P.1 Distinzione conduttori in relazione alla funzione <i>P.1 Colors of conductors according to their function</i>	366
B.4 Portate dei conduttori secondo NFPA 70 (NEC) <i>B.4 Ampacities of conductors according to NFPA 70 (NEC)</i>	264	P.2 Distinzione conduttori secondo DIN 47100 <i>P.2 Colors of conductors according to DIN 47100</i>	366
B.5 Portate dei Flexible Cords and Cables secondo NFPA 70 (NEC) <i>B.5 Ampacities of Flexible Cords and Cables according to NFPA 70 (NEC)</i>	270	P.3 Distinzione conduttori secondo CEI UNEL 00722 <i>P.3 Colors of conductors according to CEI UNEL 00722</i>	367
B.6 Portate dei conduttori secondo CSA C22.1 (CE Code) <i>B.6 Ampacity of conductors according to CSA C22.1 (CE Code)</i>	279	P.4 Distinzione conduttori secondo UL508a <i>P.4 Colors of conductors according to UL508a</i>	368
B.7 Portate dei conduttori secondo EN 60204-1 <i>B.7 Current-carrying capacity of conductors according to EN 60204-1</i>	293	P.5 Distinzione conduttori secondo NFPA 79 <i>P.5 Colors of conductors according to NFPA 79</i>	369
B.8 Portate dei conduttori secondo VDE 0298-4 <i>B.8 Ampacities of conductors according to VDE 0298-4</i>	298	P.6 Distinzione conduttori secondo EN 60204-1 <i>P.6 Colors of conductors according to EN 60204-1</i>	369
B.9 Portate dei conduttori secondo IEC 60364-5-52/CEI UNEL 35024-1/CEI 64-8 <i>B.9 Ampacities of conductors according to IEC 60364-5-52/CEI UNEL 35024-1/CEI 64-8</i>	306	P.7 Distinzione conduttori secondo ICEA (Insulated Cable Engineers Association) <i>P.7 Colors of conductors according to ICEA (Insulated Cable Engineers Association)</i>	370
Appendice C. Spazi di cablaggio all'interno dei quadri elettrici <i>Appendix C. Wire bending space at filed wiring terminals</i>	320	P.8 Distinzione conduttori secondo specifica interna Tipo 1-P <i>P.8 Colors of conductors according to internal specification Type 1-P</i>	371
Appendice D. Tabelle di assorbimento dei motori <i>Appendix D. Motors' full-load currents</i>	321	P.9 Distinzione conduttori secondo specifica interna Tipo 1-C <i>P.9 Colors of conductors according to internal specification Type 1-C</i>	371
D.1 Assorbimento dei motori in corrente alternata secondo UL 508a <i>D.1 Motors' full-load currents with alternate current according to UL 508a</i>	321	P.10 Distinzione conduttori secondo specifica interna Tipo 1-T <i>P.10 Colors of conductors according to internal specification Type 1-T</i>	371
D.2 Assorbimento dei motori in corrente continua secondo UL 508a <i>D.2 Motors' full-load currents with direct current according to UL 508a</i>	322	P.11 Distinzione conduttori secondo specifica interna Tipo 2-C <i>P.11 Colors of conductors according to internal specification Type 2-C</i>	372
Appendice E. Specifiche dei conduttori per cavi secondo NFPA 70 <i>Appendix E. Conductors for general wiring according to NFPA 70</i>	323	P.12 Distinzione conduttori secondo specifica interna Tipo 3-P <i>P.12 Colors of conductors according to internal specification Type 3-P</i>	372
Appendice F. Specifiche Flexible cords and cables secondo NFPA 70 <i>Appendix F. Flexible cords and cables according to NFPA 70</i>	326	P.13 Distinzione conduttori secondo specifica interna Tipo 4-C <i>P.13 Colors of conductors according to internal specification Type 4-C</i>	372
Appendice G. Marcatura di cavi e conduttori secondo UL <i>Appendix G. Wires and cables marking according to UL</i>	332	P.14 Distinzione conduttori secondo specifica interna Tipo 5-P <i>P.14 Colors of conductors according to internal specification Type 5-P</i>	373
Appendice H. Style, definizione e riferimenti <i>Appendix H. Style, definition and reference</i>	337	P.15 Distinzione conduttori secondo specifica interna Tipo 6-T <i>P.15 Colors of conductors according to internal specification Type 6-T</i>	373
Appendice I. Nomenclatura dei cavi Ethernet <i>Appendix I. Ethernet cables' naming</i>	340	P.16 Distinzione conduttori secondo specifica interna Tipo 7-P <i>P.16 Colors of conductors according to internal specification Type 7-P</i>	374
Appendice J. Prodotti Listed o prodotti Recognized <i>Appendix J. Listed or Recognized products</i>	341	P.17 Distinzione conduttori secondo specifica interna Tipo 8-C <i>P.17 Colors of conductors according to internal specification Type 8-C</i>	374
J.1 I prodotti Listed <i>J.1 Listed products</i>	341	P.18 Distinzione conduttori secondo specifica interna Tipo 9-P <i>P.18 Colors of conductors according to internal specification Type 9-P</i>	374
J.2 I prodotti Recognized <i>J.2 Recognized products</i>	342	P.19 Distinzione conduttori secondo specifica interna Tipo 10-P <i>P.19 Colors of conductors according to internal specification Type 10-P</i>	375
J.3 Differenza fra prodotti Listed e prodotti Recognized <i>J.3 Difference between Listed products and Recognized products</i>	342	P.20 Distinzione conduttori secondo HD 308 S2 <i>P.20 Colors of conductors according to HD 308 S2</i>	375
J.4 L'intercambiabilità dei marchi di certificazione <i>J.4 Interchangeable product certification marks</i>	343	Appendice Q. Riferimenti normativi <i>Appendix Q. Standard refere</i>	376
Appendice K. I gradi di protezione degli involucri <i>Appendix K. Degrees of protection provided by enclosures</i>	345	Appendice R. Definizioni <i>Appendix R. Definitions</i>	378
K.1 Grado di protezione IP <i>K.1 Degree of protection IP</i>	345	Appendice S. Simboli e marchi <i>Appendix S. Symbols and marks</i>	382
K.2 Grado di protezione NEMA <i>K.2 Degree of protection NEMA</i>	348	Appendice T. Unità di misura <i>Appendix T. Unites of measurement</i>	383
K.3 Correlazione tra gradi di protezione <i>K.3 Conversion between degrees of protection</i>	349		

Indice per area di installazione - Index based on installation area

Prodotto Product		Area di installazione				
		Area A1 Installazione all'interno di canalizzazioni (cable tray) o tubazioni (raceway) a contatto diretto con le strutture dell'edificio (pavimenti, soffitti, pareti). <i>Installation inside cable trays or inside raceways in direct contact with the structures of the buildings (ceiling, walls, floors).</i>	Area A2 Installazione in canalizzazioni (cable tray) o tubazioni (raceway) a bordo macchina. <i>Installation in cable trays or in raceways on the machinery.</i>	Area A3 Installazione esposta a bordo macchina. <i>Exposed installation on the machinery.</i>	Area Q1 Installazione in quadro elettrico. <i>Installation in control panel.</i>	Area Q2 Installazione in quadro elettrico a bordo macchina. <i>Installation in control panel on the machinery.</i>
Famiglia Family	Serie Series	Norme di riferimento per l'installazione ove possibile				
Cavi unipolari Single core cables	900		NFPA 79 CSA C22.1 (CE Code) ⁽¹⁾	NFPA 79 CSA C22.1 (CE Code)	CSA C22.2 No. 286	CSA C22.2 No. 286
	910		IEC NFPA 79 CSA C22.1 (CE Code) ⁽¹⁾	NFPA 79 CSA C22.1 (CE Code)	UL 508a CSA C22.2 No. 286	UL 508a CSA C22.2 No. 286
	911		IEC NFPA 79 CSA C22.1 (CE Code) ⁽¹⁾	IEC NFPA 79 CSA C22.1 (CE Code)	IEC UL 508a CSA C22.2 No. 286	IEC UL 508a CSA C22.2 No. 286
	950			NFPA 79 CSA C22.1 (CE Code)	UL 508a CSA C22.2 No. 286	UL 508a CSA C22.2 No. 286
	960, 960S	IEC	IEC NFPA 79 CSA C22.1 (CE Code) ⁽¹⁾	IEC NFPA 79 CSA C22.1 (CE Code)	IEC UL 508a CSA C22.2 No. 286	IEC UL 508a CSA C22.2 No. 286
	1000	NFPA 70 (NEC)	NFPA 79	NFPA 79 CSA C22.1 (CE Code)	UL 508a	UL 508a
	1010S	IEC NFPA 70 (NEC)	IEC NFPA 79	IEC NFPA 79	IEC UL 508a	IEC UL 508a
	1050, 1050S	IEC	IEC	IEC NFPA 79 CSA C22.1 (CE Code)	IEC UL 508a CSA C22.2 No. 286	IEC UL 508a CSA C22.2 No. 286
	1060, 1070	IEC NFPA 70 (NEC) ⁽¹⁾	IEC NFPA 79 CSA C22.1 (CE Code) ⁽¹⁾	IEC NFPA 79 CSA C22.1 (CE Code)	IEC UL 508a CSA C22.2 No. 286	IEC UL 508a CSA C22.2 No. 286
	1075	IEC NFPA 70 (NEC) ⁽¹⁾	IEC NFPA 79 CSA C22.1 (CE Code) ⁽¹⁾	IEC NFPA 79 CSA C22.1 (CE Code)	IEC UL 508a CSA C22.2 No. 286	IEC UL 508a CSA C22.2 No. 286
Cavi multipolari per posa fissa Cables for fixed applications	50, 50S	IEC	IEC	IEC	IEC	IEC
	100, 100S, 105, 105S	IEC	IEC	IEC	IEC	IEC
	150, 150S, 151	IEC	IEC	IEC	IEC	IEC
	200, 200S	IEC	IEC	IEC	IEC	IEC
	345, 345S, 361S, 370S, 380, 380S	IEC	IEC NFPA 79 CSA C22.1 (CE Code) ⁽¹⁾	IEC NFPA 79 CSA C22.1 (CE Code)	IEC UL 508a CSA C22.2 No. 286	IEC UL 508a CSA C22.2 No. 286
	365S	IEC NFPA 70 (NEC) CSA C22.1 (CE Code)	IEC NFPA 79 CSA C22.1 (CE Code) ⁽¹⁾	IEC NFPA 79 CSA C22.1 (CE Code)	IEC UL 508a CSA C22.2 No. 286	IEC UL 508a CSA C22.2 No. 286
	8110, 8110S	IEC NFPA 70 (NEC) CSA C22.1 (CE Code)	IEC NFPA 79 CSA C22.1 (CE Code)	IEC NFPA 79 CSA C22.1 (CE Code)	IEC UL 508a CSA C22.2 No. 286	IEC UL 508a CSA C22.2 No. 286
Cavi multipolari per posa mobile Cables for dynamic applications	8410, 8410S	IEC NFPA 70 (NEC) CSA C22.1 (CE Code)	IEC NFPA 79 CSA C22.1 (CE Code)	IEC NFPA 79 CSA C22.1 (CE Code)	IEC UL 508a CSA C22.2 No. 286	IEC UL 508a CSA C22.2 No. 286
	400S	IEC	IEC NFPA 79 CSA C22.1 (CE Code)	IEC NFPA 79 CSA C22.1 (CE Code)	IEC UL 508a CSA C22.2 No. 286	IEC UL 508a CSA C22.2 No. 286
	410, 410S	IEC	IEC NFPA 79 CSA C22.1 (CE Code)	IEC NFPA 79 CSA C22.1 (CE Code)	IEC UL 508a CSA C22.2 No. 286	IEC UL 508a CSA C22.2 No. 286
	440, 440S	IEC	IEC NFPA 79 CSA C22.1 (CE Code) ⁽¹⁾	IEC NFPA 79 CSA C22.1 (CE Code)	IEC UL 508a CSA C22.2 No. 286	IEC UL 508a CSA C22.2 No. 286
	600, 600S	IEC	IEC NFPA 79 CSA C22.1 (CE Code) ⁽¹⁾	IEC NFPA 79 CSA C22.1 (CE Code)	IEC UL 508a CSA C22.2 No. 286	IEC UL 508a CSA C22.2 No. 286

Nota 1. Quanto specificato è da considerarsi come indicazione di massima che deve essere verificata da tecnici qualificati ed in accordo alle specifiche normative di riferimento.

Nota 2. Per maggiori dettagli sulle aree di installazione fare riferimento all'immagine presente al termine della tabella.

Note 1. The above table contains general suggestions that must be verified by qualified person and must be according to local regulations and standards.

Note 2. More details on the installation areas are in the image at the end of the table.

Indice per area di installazione - Index based on installation area

Installation area					Prodotto Product	Serie Series	Famiglia Family
Area M1	Area M2	Area M3	Area H1	Area H2			
Installazione in catena porta cavi. <i>Installation in drag chains.</i>	Installazione esposta a bordo macchina su parti in movimento. <i>Exposed installation on moving parts on machinery.</i>	Installazione a contatto diretto con il bordo macchina su parti in movimento. <i>Installation on moving parts in direct contact with the machinery.</i>	Installazione in zona pericolosa (Hazardous Locations). <i>Installation in hazardous locations.</i>	Installazione in quadro elettrico in zona pericolosa (Hazardous Locations). <i>Installation in control panel in hazardous locations.</i>			
<i>Standards reference if installation is possibile</i>							
				IEC	900	Cavi unipolari Single core cables	
				IEC	910		
				IEC	911		
					950		
IEC NFPA 79 CSA C22.1 (CE Code)	IEC ⁽³⁾ NFPA 79 ⁽³⁾ CSA C22.1 (CE Code) ⁽³⁾	IEC NFPA 79 CSA C22.1 (CE Code)		IEC	960, 960S		
				IEC	1000		
				IEC	1010S		
				IEC	1050, 1050S		
				IEC	1060, 1070		
IEC NFPA 79 CSA C22.1 (CE Code)	IEC ⁽³⁾ NFPA 79 ⁽³⁾ CSA C22.1 (CE Code) ⁽³⁾	IEC NFPA 79 CSA C22.1 (CE Code)		IEC	1075		
			IEC	IEC	50, 50S	Cavi multipolari per posa fissa Cables for fixed applications	
			IEC	IEC	100, 100S, 105, 105S		
			IEC	IEC	150, 150S, 151		
			IEC	IEC	200, 200S		
			IEC	IEC	345, 345S, 361S, 370S, 380, 380S		
			IEC NFPA 70 (NEC) CSA C22.1	IEC NFPA 70 (NEC) CSA C22.1	365S		
			IEC NFPA 70 (NEC) CSA C22.1	IEC NFPA 70 (NEC) CSA C22.1	8110, 8110S		
IEC NFPA 79 CSA C22.1 (CE Code)	IEC ⁽³⁾ NFPA 79 ⁽³⁾ CSA C22.1 (CE Code) ⁽³⁾	IEC NFPA 79 CSA C22.1 (CE Code)	IEC NFPA 70 (NEC) ⁽⁴⁾	IEC NFPA 70 (NEC) CSA C22.1	8410, 8410S	Cavi multipolari per posa mobile Cables for dynamic applications	
IEC NFPA 79 CSA C22.1 (CE Code)	IEC ⁽³⁾ NFPA 79 ⁽³⁾ CSA C22.1 (CE Code) ⁽³⁾	IEC NFPA 79 CSA C22.1 (CE Code)	IEC	IEC	400S		
IEC NFPA 79 CSA C22.1 (CE Code)	IEC ⁽³⁾ NFPA 79 ⁽³⁾ CSA C22.1 (CE Code) ⁽³⁾	IEC NFPA 79 CSA C22.1 (CE Code)	IEC	IEC	410, 410S		
IEC NFPA 79 CSA C22.1 (CE Code)	IEC ⁽³⁾ NFPA 79 ⁽³⁾ CSA C22.1 (CE Code) ⁽³⁾	IEC NFPA 79 CSA C22.1 (CE Code)	IEC	IEC	440, 440S		
IEC NFPA 79 CSA C22.1 (CE Code)	IEC NFPA 79 CSA C22.1 (CE Code)	IEC NFPA 79 CSA C22.1 (CE Code)	IEC	IEC	600, 600S		

(1) Se l'installazione è in canalizzazione (cable tray) il cavo deve essere protetto in tubazione (raceway).

(2) Solo se protetto in tubazione (raceway).

(3) Previa verifica del tipo di movimento (flessione o flessotorsione).

(4) Solo se protetto in tubazione (raceway) adatta per zona pericolosa.

(1) If the installation is in cable tray, the cable must be protected in a raceway.

(2) Only if protected in raceway.

(3) Only after verification of the type of movement (flexion and/or torsion).

(4) Only if protected in raceway for hazardous locations.

Prodotto Product		Area di installazione				
		Area A1	Area A2	Area A3	Area Q1	Area Q2
		Installazione all'interno di canalizzazioni (cable tray) o tubazioni (raceway) a contatto diretto con le strutture dell'edificio (pavimenti, soffitti, pareti). <i>Installation inside cable trays or inside raceways in direct contact with the structures of the buildings (ceiling, walls, floors).</i>	Installazione in canalizzazioni (cable tray) o tubazioni (raceway) a bordo macchina. <i>Installation in cable trays or in raceways on the machinery.</i>	Installazione esposta a bordo macchina. <i>Exposed installation on the machinery.</i>	Installazione in quadro elettrico. <i>Installation in control panel.</i>	Installazione in quadro elettrico a bordo macchina. <i>Installation in control panel on the machinery.</i>
Famiglia Family	Serie Series	Norme di riferimento per l'installazione ove possibile				
Cavi per trasmissione dati Data transmission cables	71000	IEC	IEC NFPA 79 CSA C22.1 (CE Code) ⁽¹⁾	IEC NFPA 79 CSA C22.1 (CE Code)	IEC UL 508a CSA C22.2 No. 286	IEC UL 508a CSA C22.2 No. 286
	71100	IEC	IEC NFPA 79 CSA C22.1 (CE Code) ⁽¹⁾	IEC NFPA 79 CSA C22.1 (CE Code)	IEC UL 508a CSA C22.2 No. 286	IEC UL 508a CSA C22.2 No. 286
	71600	IEC NFPA 70 (NEC) CSA C22.1 (CE Code)	IEC NFPA 79 CSA C22.1 (CE Code) ⁽¹⁾	IEC NFPA 79 CSA C22.1 (CE Code)	IEC UL 508a CSA C22.2 No. 286	IEC UL 508a CSA C22.2 No. 286
	73000	IEC	IEC NFPA 79 CSA C22.1 (CE Code) ⁽¹⁾	IEC NFPA 79 CSA C22.1 (CE Code)	IEC UL 508a CSA C22.2 No. 286	IEC UL 508a CSA C22.2 No. 286
	73100	IEC	IEC NFPA 79 CSA C22.1 (CE Code) ⁽¹⁾	IEC NFPA 79 CSA C22.1 (CE Code)	IEC UL 508a CSA C22.2 No. 286	IEC UL 508a CSA C22.2 No. 286
	74100	IEC	IEC NFPA 79 CSA C22.1 (CE Code) ⁽¹⁾	IEC NFPA 79 CSA C22.1 (CE Code)	IEC UL 508a CSA C22.2 No. 286	IEC UL 508a CSA C22.2 No. 286
	74000	IEC	IEC NFPA 79 CSA C22.1 (CE Code) ⁽¹⁾	IEC NFPA 79 CSA C22.1 (CE Code)	IEC UL 508a CSA C22.2 No. 286	IEC UL 508a CSA C22.2 No. 286
	75000	IEC	IEC NFPA 79 CSA C22.1 (CE Code) ⁽¹⁾	IEC NFPA 79 CSA C22.1 (CE Code)	IEC UL 508a CSA C22.2 No. 286	IEC UL 508a CSA C22.2 No. 286
	75500	IEC NFPA 70 (NEC) CSA C22.1 (CE Code)	IEC NFPA 79 CSA C22.1 (CE Code) ⁽¹⁾	IEC NFPA 79 CSA C22.1 (CE Code)	IEC UL 508a CSA C22.2 No. 286	IEC UL 508a CSA C22.2 No. 286
	75100	IEC	IEC	IEC	IEC	IEC
	75200	IEC	IEC NFPA 79 CSA C22.1 (CE Code) ⁽¹⁾	IEC NFPA 79 CSA C22.1 (CE Code)	IEC UL 508a CSA C22.2 No. 286	IEC UL 508a CSA C22.2 No. 286
	75600, 75700	IEC NFPA 70 (NEC) CSA C22.1 (CE Code)	IEC NFPA 79 CSA C22.1 (CE Code) ⁽¹⁾	IEC NFPA 79 CSA C22.1 (CE Code)	IEC UL 508a CSA C22.2 No. 286	IEC UL 508a CSA C22.2 No. 286
	77000	IEC	IEC NFPA 79 CSA C22.1 (CE Code) ⁽¹⁾	IEC NFPA 79 CSA C22.1 (CE Code)	IEC UL 508a CSA C22.2 No. 286	IEC UL 508a CSA C22.2 No. 286
	77100	IEC	IEC NFPA 79 CSA C22.1 (CE Code) ⁽¹⁾	IEC NFPA 79 CSA C22.1 (CE Code)	IEC UL 508a CSA C22.2 No. 286	IEC UL 508a CSA C22.2 No. 286

Nota 1. Quanto specificato è da considerarsi come indicazione di massima che deve essere verificata da tecnici qualificati ed in accordo alle specifiche normative di riferimento.

Nota 2. Per maggiori dettagli sulle aree di installazione fare riferimento all'immagine presente al termine della tabella.

(1) Se l'installazione è in canalizzazione (cable tray) il cavo deve essere protetto in tubazione (raceway).

(2) Solo se protetto in tubazione (raceway).

(3) Previa verifica del tipo di movimento (flessione o flessotorsione).

(4) Solo se protetto in tubazione (raceway) adatta per zona pericolosa.

Note 1. The above table contains general suggestions that must be verified by qualified person and must be according to local regulations and standards.

Note 2. More details on the installation areas are in the image at the end of the table.

(1) If the installation is in cable tray, the cable must be protected in a raceway.

(2) Only if protected in raceway.

(3) Only after verification of the type of movement (flexion and/or torsion).

(4) Only if protected in raceway for hazardous locations.

Indice per area di installazione - Index based on installation area

Installation area					Prodotto Product	Famiglia Family
Area M1	Area M2	Area M3	Area H1	Area H2		
Installazione in catena porta cavi. <i>Installation in drag chains.</i>	Installazione esposta a bordo macchina su parti in movimento. <i>Exposed installation on moving parts on machinery.</i>	Installazione a contatto diretto con il bordo macchina su parti in movimento. <i>Installation on moving parts in direct contact with the machinery.</i>	Installazione in zona pericolosa (Hazardous Locations). <i>Installation in hazardous locations.</i>	Installazione in quadro elettrico in zona pericolosa (Hazardous Locations). <i>Installation in control panel in hazardous locations.</i>		
<i>Standards reference if installation is possibile</i>					Serie Series	
			IEC	IEC	71000	Cavi per trasmissione dati Data transmission cables
IEC CSA C22.1 (CE Code)	IEC ⁽³⁾ NFPA 79 ⁽³⁾ CSA C22.1 (CE Code) ⁽³⁾	IEC NFPA 79 CSA C22.1 (CE Code)	IEC	IEC	71100	
IEC NFPA 79 CSA C22.1 (CE Code)	IEC ⁽³⁾ NFPA 79 ⁽³⁾ CSA C22.1 (CE Code) ⁽³⁾	IEC NFPA 79 CSA C22.1 (CE Code)	IEC NFPA 70 (NEC) ⁽⁴⁾	IEC NFPA 70 (NEC) CSA C22.1	71600	
			IEC	IEC	73000	
IEC NFPA 79 CSA C22.1 (CE Code)	IEC ⁽³⁾ NFPA 79 ⁽³⁾ CSA C22.1 (CE Code) ⁽³⁾	IEC NFPA 79 CSA C22.1 (CE Code)	IEC	IEC	73100	
			IEC	IEC	74100	
IEC NFPA 79 CSA C22.1 (CE Code)	IEC ⁽³⁾ NFPA 79 ⁽³⁾ CSA C22.1 (CE Code) ⁽³⁾	IEC NFPA 79 CSA C22.1 (CE Code)	IEC	IEC	74000	
			IEC	IEC	75000	
			IEC NFPA 70 (NEC) ⁽⁴⁾	IEC NFPA 70 (NEC) CSA C22.1	75500	
IEC	IEC ⁽³⁾	IEC	IEC	IEC	75100	
IEC NFPA 79 CSA C22.1 (CE Code)	IEC ⁽³⁾ NFPA 79 ⁽³⁾ CSA C22.1 (CE Code) ⁽³⁾	IEC NFPA 79 CSA C22.1 (CE Code)	IEC	IEC	75200	
IEC NFPA 79 CSA C22.1 (CE Code)	IEC ⁽³⁾ NFPA 79 ⁽³⁾ CSA C22.1 (CE Code) ⁽³⁾	IEC NFPA 79 CSA C22.1 (CE Code)	IEC NFPA 70 (NEC) ⁽⁴⁾	IEC NFPA 70 (NEC) CSA C22.1	75600, 75700	
			IEC	IEC	77000	
IEC NFPA 79 CSA C22.1 (CE Code)	IEC ⁽³⁾ NFPA 79 ⁽³⁾ CSA C22.1 (CE Code) ⁽³⁾	IEC NFPA 79 CSA C22.1 (CE Code)	IEC	IEC	77100	

Prodotto Product		Area di installazione				
		Area A1	Area A2	Area A3	Area Q1	Area Q2
		Installazione all'interno di canalizzazioni (cable tray) o tubazioni (raceway) a contatto diretto con le strutture dell'edificio (pavimenti, soffitti, pareti). <i>Installation inside cable trays or inside raceways in direct contact with the structures of the buildings (ceiling, walls, floors).</i>	Installazione in canalizzazioni (cable tray) o tubazioni (raceway) a bordo macchina. <i>Installation in cable trays or in raceways on the machinery.</i>	Installazione esposta a bordo macchina. <i>Exposed installation on the machinery.</i>	Installazione in quadro elettrico. <i>Installation in control panel.</i>	Installazione in quadro elettrico a bordo macchina. <i>Installation in control panel on the machinery.</i>
Famiglia Family	Serie Series	Norme di riferimento per l'installazione ove possibile				
Cavi per trasmissione dati Data transmission cables	78000	IEC	IEC NFPA 79 CSA C22.1 (CE Code) ⁽¹⁾	IEC NFPA 79 CSA C22.1 (CE Code)	IEC UL 508a CSA C22.2 No. 286	IEC UL 508a CSA C22.2 No. 286
	78100	IEC	IEC NFPA 79 CSA C22.1 (CE Code) ⁽¹⁾	IEC NFPA 79 CSA C22.1 (CE Code)	IEC UL 508a CSA C22.2 No. 286	IEC UL 508a CSA C22.2 No. 286
	DATA	IEC	IEC NFPA 79 CSA C22.1 (CE Code) ⁽¹⁾	IEC NFPA 79 CSA C22.1 (CE Code)	IEC UL 508a CSA C22.2 No. 286	IEC UL 508a CSA C22.2 No. 286
Cavi "Made in USA" "Made in USA" cables	Flexible cord S, STOW, SOOW, W, G, G-GC	NFPA 70 (NEC) CSA C22.1 (CE Code)	NFPA 79 CSA C22.1 (CE Code) ⁽¹⁾	NFPA 79 CSA C22.1 (CE Code)	UL 508a	UL 508a
	Flexible cord SJ, SJOOW, SJTOW, SJT	NFPA 70 (NEC) CSA C22.1 (CE Code)	NFPA 79 CSA C22.1 (CE Code) ⁽¹⁾	NFPA 79 CSA C22.1 (CE Code)	UL 508a	UL 508a
	Tray Cable "USA"	NFPA 70 (NEC) CSA C22.1 (CE Code)	NFPA 79 CSA C22.1 (CE Code) ⁽¹⁾	NFPA 79	UL 508a	UL 508a
	PLTC/ITC "USA"	NFPA 70 (NEC) CSA C22.1 (CE Code)	NFPA 79 CSA C22.1 (CE Code) ⁽¹⁾	NFPA 79	UL 508a	UL 508a
	MC-HL	NFPA 70 (NEC) CSA C22.1 (CE Code)	NFPA 79 CSA C22.1 (CE Code) ⁽¹⁾	NFPA 79 CSA C22.1 (CE Code)	UL 508a	UL 508a
	Teck 90-HL	CSA C22.1 (CE Code)	CSA C22.1 (CE Code)	CSA C22.1 (CE Code)	CSA C22.2 No. 286	CSA C22.2 No. 286

Nota 1. Quanto specificato è da considerarsi come indicazione di massima che deve essere verificata da tecnici qualificati ed in accordo alle specifiche normative di riferimento.

Nota 2. Per maggiori dettagli sulle aree di installazione fare riferimento all'immagine presente al termine della tabella.

- (1) Se l'installazione è in canalizzazione (cable tray) il cavo deve essere protetto in tubazione (raceway).
- (2) Solo se protetto in tubazione (raceway).
- (3) Previa verifica del tipo di movimento (flessione o flessotorsione).
- (4) Solo se protetto in tubazione (raceway) adatta per zona pericolosa.

Note 1. The above table contains general suggestions that must be verified by qualified person and must be according to local regulations and standards.

Note 2. More details on the installation areas are in the image at the end of the table.

- (1) If the installation is in cable tray, the cable must be protected in a raceway.
- (2) Only if protected in raceway.
- (3) Only after verification of the type of movement (flexion and/or torsion).
- (4) Only if protected in raceway for hazardous locations.

Indice per area di installazione - Index based on installation area

Installation area					Prodotto Product	
Area M1	Area M2	Area M3	Area H1	Area H2		
Installazione in catena porta cavi. <i>Installation in drag chains.</i>	Installazione esposta a bordo macchina su parti in movimento. <i>Exposed installation on moving parts on machinery.</i>	Installazione a contatto diretto con il bordo macchina su parti in movimento. <i>Installation on moving parts in direct contact with the machinery.</i>	Installazione in zona pericolosa (Hazardous Locations). <i>Installation in hazardous locations.</i>	Installazione in quadro elettrico in zona pericolosa (Hazardous Locations). <i>Installation in control panel in hazardous locations.</i>		
<i>Standards reference if installation is possibile</i>					Serie Series	Famiglia Family
		IEC NFPA 79 CSA C22.1 (CE Code)	IEC	IEC	78000	Cavi per trasmissione dati Data transmission cables
IEC NFPA 79 CSA C22.1 (CE Code)	IEC ⁽³⁾ NFPA 79 ⁽³⁾ CSA C22.1 (CE Code) ⁽³⁾	IEC NFPA 79 CSA C22.1 (CE Code)	IEC	IEC	78100	
			IEC	IEC	DATA	
NFPA 79 ⁽³⁾	NFPA 79 ⁽³⁾	NFPA 79 ⁽³⁾ CSA C22.1 (CE Code) ⁽³⁾	NFPA 70 (NEC) ⁽⁴⁾	UL 508a	Flexible cord S, STOW, S00W, W, G, G-GC	Cavi "Made in USA" "Made in USA" cables
NFPA 79 ⁽³⁾	NFPA 79 ⁽³⁾	NFPA 79 ⁽³⁾ CSA C22.1 (CE Code) ⁽³⁾			Flexible cord SJ, SJ00W, SJTOW, SJT	
			NFPA 70 (NEC) ⁽⁴⁾	UL 508a	Tray Cable "USA"	
			NFPA 70 (NEC) ⁽⁴⁾	UL 508a	PLTC/ITC "USA"	
			NFPA 70 (NEC)	UL 508a	MC-HL	
			CSA C22.1 (CE Code)	CSA C22.2 No. 286	Teck 90-HL	

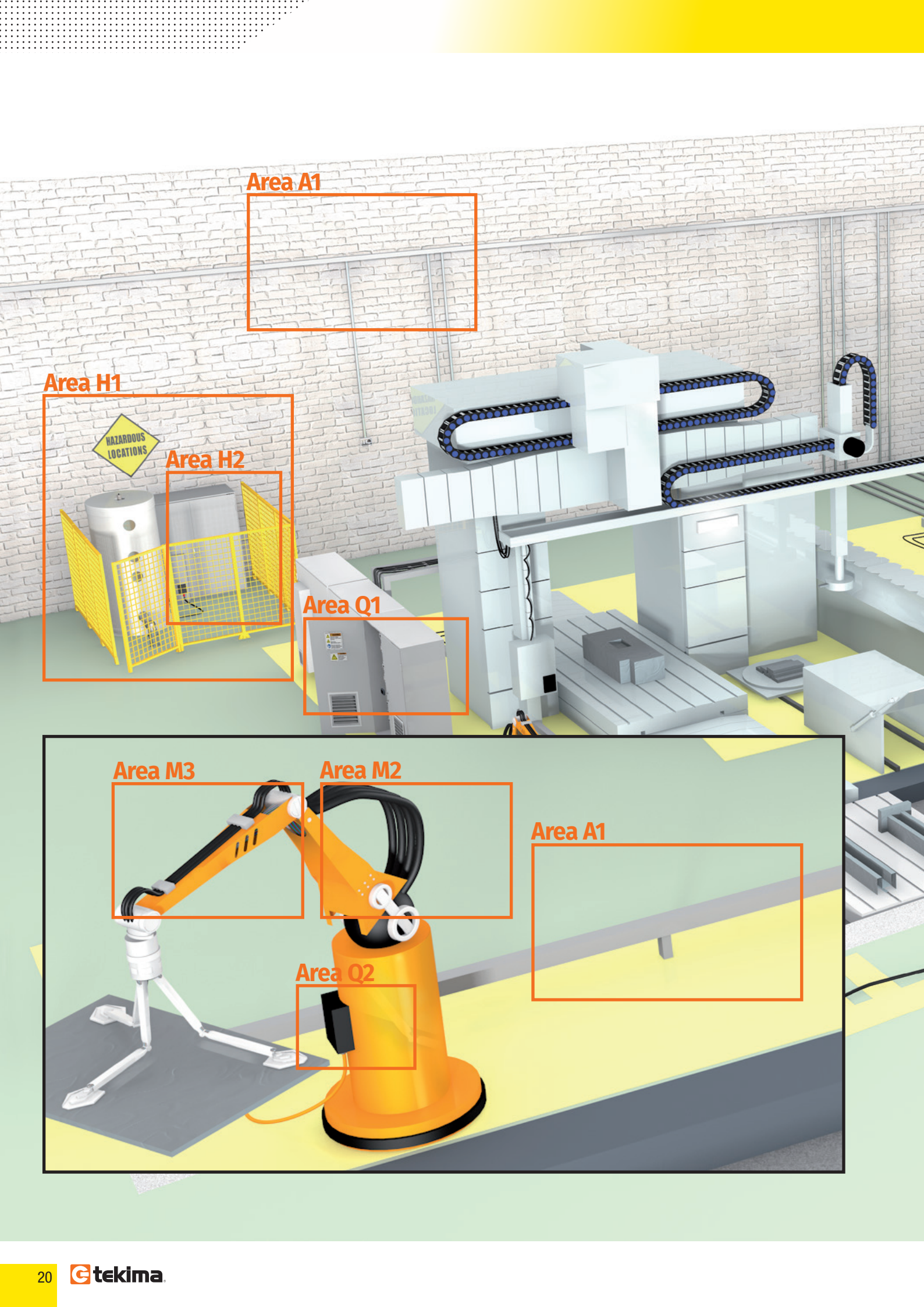

Area A1

Area H1

Area H2

Area Q1

Area M3

Area M2

Area Q2

Area A1

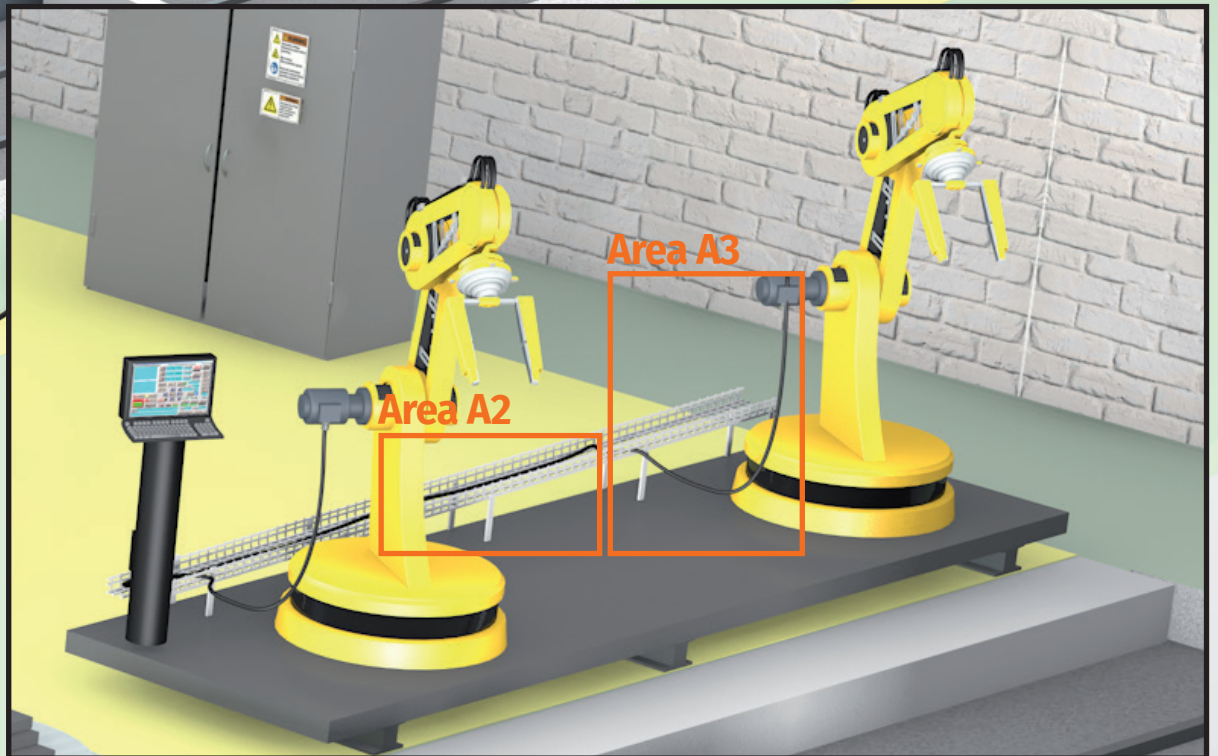
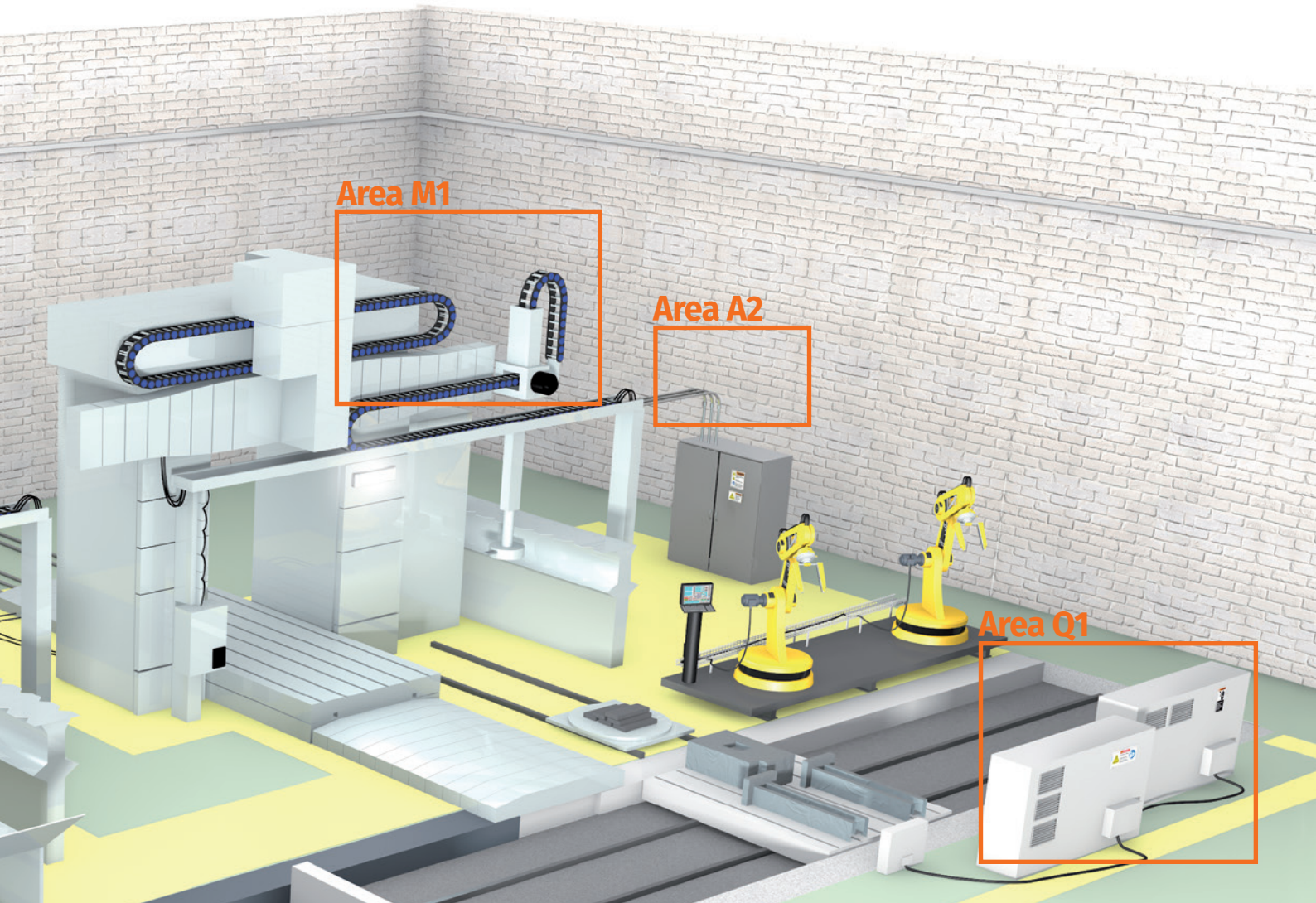



Cavi unipolari
Single core cables

**SERIES
N0000**

Trecce tonde flessibili in rame rosso e in rame stagnato

Bare or tinned flexible copper braids



Codifiche e dimensioni - Coding and dimensions

Codice <i>Code</i>	Sezione <i>Size [AWG]</i>	Diametro <i>Diameter [mm]</i>	Filo <i>Wire [mm]</i>	Peso <i>Weight [kg/km]</i>	Tipo rame <i>Copper type</i>
CVC600_NR600	6	4,0	0,2	60	Rosso - Bare
CVCB10_NR600	10	4,5	0,2	100	Rosso - Bare
CVCB16_NR600	16	5,8	0,2	160	Rosso - Bare
CVCB25_NR600	25	7,3	0,2	250	Rosso - Bare
CVCB35_NR600	35	8,2	0,2	350	Rosso - Bare
CVCB50_NR600	50	9,6	0,2	500	Rosso - Bare
CVCB75_NR600	75	12,0	0,2	750	Rosso - Bare
CVCL10_NR600	100	14,0	0,2	1000	Rosso - Bare
CVC600_NS600	6	4,0	0,2	60	Stagnato - Tinned
CVCB10_NS600	10	4,5	0,2	100	Stagnato - Tinned
CVCB16_NS600	16	5,8	0,2	160	Stagnato - Tinned
CVCB25_NS600	25	7,3	0,2	250	Stagnato - Tinned
CVCB35_NS600	35	8,2	0,2	350	Stagnato - Tinned
CVCB50_NS600	50	9,6	0,2	500	Stagnato - Tinned
CVCB75_NS600	75	12,0	0,2	750	Stagnato - Tinned
CVCL10_NS600	100	14,0	0,2	1000	Stagnato - Tinned

Composizione del codice - Code composition

CVC	□□□	_	□□□□□	Tipo rame <i>Copper type</i>	Inserire <i>To be inserted</i>
Sezione <i>Size</i>				Rosso - Bare	NR600
1, 1,5, ..., 6 mm ²				Stagnato - Tinned	NS600
10, 16, ..., 95 mm ²					
100, 120, ..., 240 mm ²					
	Inserire <i>To be inserted</i>				
	100, 150, ..., 600				
	B10, B16, ..., B95				
	L10, L12, ..., L24				

SERIES
900

Cavi unipolari Style 1569/1007

Single core cables Style 1569/1007



"UL Recognized", posa fissa, non schermati - Fixed application, unshielded

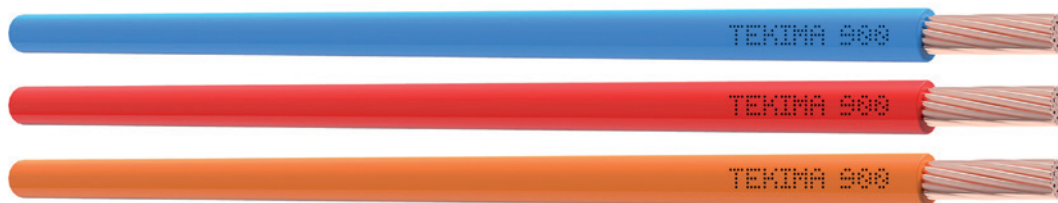

Impiego - Use

Internal Wiring of Appliances (cablaggio interno di apparecchiature) con temperatura di esercizio fino a 105°C o 80°C (a seconda dello style) e tensioni di 300V.

Internal Wiring of Appliances with temperature ranges up to 105°C or 80°C (based on the style) and 300V voltages.

Marcatura - Marking

TEKIMA 09000 – c(JR)us AWM Style 1569 AWG 16 300 V 105°C VW-1 - AWM Style 1007 AWG 16 300 V 80°C VW-1 E314444 AWM I A/B FT2 – (prod. reference)

Dati tecnici - Technical data

Caratteristica - Characteristics	Valore/proprietà - Value/property
Conduttore <i>Conductor</i>	Trefolo in rame <i>Copper strand</i>
Isolamento <i>Insulation</i>	PVC conforme a UL 1581 class 43 <i>PVC according to with UL 1581 class 43</i>
Temperatura di esercizio <i>Temperature range</i>	-40°C +80°C (Style 1007), +105°C (Style 1569)
Tensione nominale <i>Voltage rating</i>	300 V
Raggio di curvatura <i>Bending radius</i>	6 volte diametro esterno del cavo <i>6 x cable outer diameter</i>
Riferimenti normativi costruttivi <i>Standards of construction</i>	UL 758, UL 1581, cURus AWM Style 1569/1007
Riferimenti normativi d'impiego <i>Standards of use</i>	Style 1569/1007, CSA C22.1 (CE Code), CSA C22.2 No.286

Codifiche e dimensioni - Coding and dimensions

Codice - Code	Sezione - Size [AWG]	Sezione - Size [mm ²]	Diametro - Diameter [mm]	Peso - Weight [kg/km]
CVCW28_09000_□□	28	0,081	1,30	2,8
CVCW26_09000_□□	26	0,129	1,40	3,2
CVCW24_09000_□□	24	0,205	1,50	4
CVCW22_09000_□□	22	0,326	1,70	6
CVCW20_09000_□□	20	0,518	1,90	8
CVCW18_09000_□□	18	0,823	2,20	12
CVCW16_09000_□□	16	1,31	2,40	16
CVCW14_09000_□□	14	2,08	3,00	25
CVCW12_09000_□□	12	3,31	3,30	37
CVCW10_09000_□□	10	5,26	4,10	60

In fase d'ordine è necessario specificare lo Style secondo il quale si richiede il cavo, salvo disponibilità il cavo potrà avere una marcatura comprendente entrambi gli Style.
When ordering the style according to which the cable is required must be specified, subject to availability cable will have a marking comprising both Style.

Composizione del codice - Code composition

CVC	□□□	_09000_	□□
Sezione Size	Inserire To be inserted	Colore Color	Inserire To be inserted
28, ..., 10 AWG	W28, ..., W10	Arancione - Orange	AR
		Bianco - White	BI
		Bianco/blu - White/blue	BB
		Bianco/arancione - White/orange	BA
		Blu - Blue	BU
		Blu Ral 5015 - Blue Ral 5015	BL
		Giallo - Yellow	GI
		Giallo/verde - Yellow/green	GV
		Grigio - Gray	GR
		Marrone - Brown	MR
		Nero - Black	NE
		Rosa - Pink	RS
		Rosso - Red	RO
		Verde - Green	VE
		Viola - Violet	VI

SERIES
910

Cavi unipolari Style 1015/1284

Single core cables Style 1015/1284



"UL Recognized", posa fissa, non schermati - Fixed application, unshielded

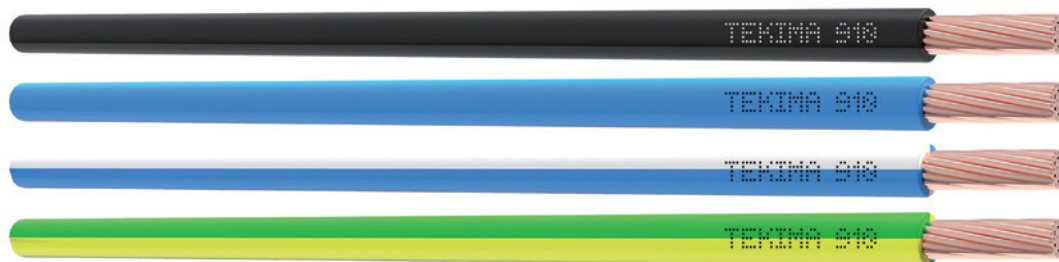

Impiego - Use

Internal Wiring of Appliances (cablaggio interno di apparecchiature) con temperature di esercizio fino a 105°C e tensioni di 600 V.

Internal Wiring of Appliances with Temperature ranges up to 105°C and 600 V voltages.

Marcatura - Marking

TEKIMA 09100 – c(UR)us AWM Style 1015 AWG 16 600 V 105°C VW-1 - E314444 AWM I A/B 600V 105°C FT2 – (prod.reference)

Dati tecnici - Technical data

Caratteristica - Characteristics	Valore/proprietà - Value/property
Conduttore <i>Conductor</i>	Trefolo flessibile in rame rosso o stagnato <i>Red or tinned copper flexible strand</i>
Isolamento <i>Insulation</i>	PVC conforme a UL 1581 class 43 <i>PVC according to with UL 1581 class 43</i>
Temperatura di esercizio <i>Temperature range</i>	-40°C, +105°C
Tensione di esercizio <i>Voltage rating</i>	600 V
Raggio di curvatura <i>Bending radius</i>	6 volte diametro esterno del cavo <i>6 x cable outer diameter</i>
Riferimenti normativi costruttivi <i>Standards of construction</i>	UL 758, UL 1581, cURus AWM Style 1015/1284
Riferimenti normativi d'impiego <i>Standards of use</i>	Style 1015/1284, ANSI/NFPA 79, UL 508a

Codifiche e dimensioni - Coding and dimensions

Codice - Code	Sezione - Size [AWG]	Sezione - Size [mm ²]	Diametro - Diameter [mm]	Peso - Weight [kg/km]	Style	Confezione - Packaging [m]
CVCW26_09100_□□	26	0,129	2,1	6,3	1015	500
CVCW24_09100_□□	24	0,205	2,3	7,8	1015	500
CVCW22_09100_□□	22	0,326	2,4	10	1015	500
CVCW20_09100_□□	20	0,518	2,6	12	1015	500
CVCW18_09100_□□	18	0,823	2,9	16	1015	100
CVCW16_09100_□□	16	1,31	3,2	22	1015	100
CVCW14_09100_□□	14	2,08	3,7	31	1015	100
CVCW12_09100_□□	12	3,31	4,2	45	1015	100
CVCW10_09100_□□	10	5,26	4,8	65	1015	100
CVCW08_09100_□□	8	8,37	7,0	110	1015	100
CVCW06_09100_□□	6	13,30	8,9	175	1015	100
CVCW04_09100_□□	4	21,20	10,1	260	1015	100
CVCW02_09100_□□	2	33,60	11,8	380	1015	50
CVCW/1_09100_□□	1/0	53,50	15,0	615	1015/1284	50
CVCW/2_09100_□□	2/0	67,40	16,0	750	1015/1284	50
CVCW/3_09100_□□	3/0	85,00	18,5	900	1015/1284	50
CVCW/4_09100_□□	4/0	107,00	20,2	1070	1015/1284	50

Composizione del codice - Code composition

CVC	□□□	_09100_	□□
Sezione <i>Size</i>	Inserire <i>To be inserted</i>	Colore <i>Color</i>	Inserire <i>To be inserted</i>
1, 2, ..., 26 AWG	W01, W02, ..., W26	Arancione - Orange	AR
1/0, ..., 4/0 AWG	W/1, W/2, ..., W/4	Bianco - White	BI
		Bianco/blu - White/blue	BB
		Blu - Blue	BU
		Blu Ral 5015 - Blue Ral 5015	BL
		Giallo - Yellow	GI
		Giallo/verde - Yellow/green	GV
		Grigio - Gray	GR
		Marrone - Brown	MR
		Nero - Black	NE
		Rosa - Pink	RS
		Rosso - Red	RO
		Verde - Green	VE
		Viola - Violet	VI

Nota. Il doppio colore è tale che uno dei colori copre almeno il 30% e non più del 70% della superficie, l'altro colore copre il resto di tale superficie.

Note. The double color is such that one of the colours covers at least 30% and not more than 70% of the surface, the other colour covering the remainder of that surface.

SERIES
911

Cavi unipolari Style 1015

Single core cables Style 1015



"UL Recognized", posa fissa, non schermati - Fixed application, unshielded

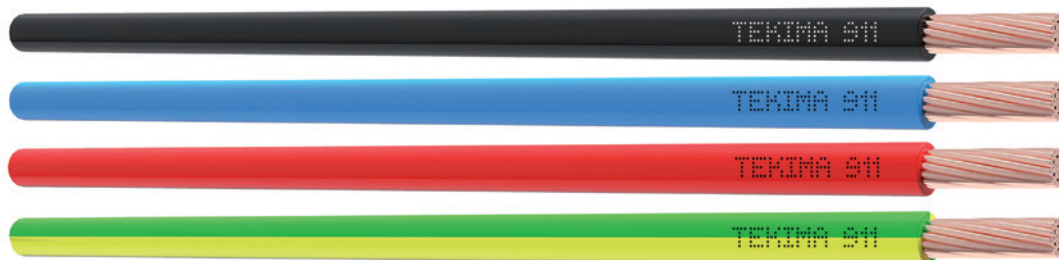

<HAR>



Impiego - Use

Cavi unipolari per il cablaggio interno di apparecchiatura (Internal Wiring of Appliances). Il prodotto è a doppia certificazione, IEC per impieghi fino a 90°C e tensioni 450/750 e UL per impieghi fino a 105°C e tensioni di 600 V.

Single core cables for Internal Wiring of Appliances. The product has a double certification, IEC for uses up to 90°C and voltages 450/750 and UL for uses up to 105°C and voltages of 600V.



Confezione "Cable Box"
Packaging "Cable Box"
L400xL400xH500 mm

Dati tecnici - Technical data

Caratteristica - Characteristics	Valore/proprietà - Value/property
Conduttore Conductor	Trefolo flessibile in rame rosso o stagnato Red or tinned copper flexible strand
Isolamento Insulation	PVC conforme a UL 758 PVC according to with UL 758
Temperatura di esercizio Temperature range	+105°C (AWM), +90°C (IEC), +90°C (HAR H05V2-K/H07V2-K <50 mm ²), +70°C (HAR H07V-K ≥50 mm ²) -40°C (posa fissa); -5°C (mobile) -40°C (fixed); -5°C (not fixed)
Tensione di esercizio Voltage rating	600 Vac, 750 Vdc (AWM); 300/500 V ≤1 mm ² , 450/750 V >1 mm ² (HAR); 300/500V ≤0,34 mm ² , 450/750 V >0,34 mm ² (IEC)
Spark test	6000 V
Raggio di curvatura Bending radius	4 volte diametro esterno del cavo (13 volte diametro esterno del cavo per movimentazioni non continue) 4 x cable outer diameter (13 x cable outer diameter for non-cyclical mobile uses)
Riferimenti normativi costruttivi Standards of construction	UL 758 I Flame res.: Test B acc. to DIN VDE 0472 part 804, IEC 60332-1-2, UL VW-1, UL/CSA FT1 I Other: CEI EN 50525-2-3 and HD 21.3 S3:1995+A1:1999+A2:2008, CSA AWM I A/B, cURus AWM Style 1015
Riferimenti normativi d'impiego Standards of use	ANSI/NFPA 79, UL 508a, Style 1015

Marcatura - Marking

TEKIMA 09110 - H07V2-K IEMMEQU <HAR> 90°C CE 2,5 mm² 90°C 450/750V IEC 60332-1-2 RoHS c(UR)us E314444 14 AWG 600V 105°C VW-1 AWM Style 1015 AWM I A/B 105°C 600V FT1 - (prod.reference)

NOTA. Per confezione in "Cable Box" la marcatura è ad incisione ed è neutra mentre per bobine e matasse è a getto di inchiostro.

NOTE. For "Cable Box" packaging the marking is by engraving and is neutral while for reels and spool it is by ink jet.

Codifiche e dimensioni - Coding and dimensions

Codice - Code	Sezione Size [mm ²]	Sezione Size [AWG/kcmil]	Diametro Diameter [mm]	Peso Weight [kg/km]	Confezione in bobina/matassa Reel/spool packaging [m]	Confezione "Cable Box" Packaging "Cable Box" [m]
CVC034_09110_□□ ⁽¹⁾	0,34	22	2,3	9	500	3000
CVC050_09110_□□	0,5	21	2,5	11	500	2500
CVC075_09110_□□	0,75	19	2,7	14	100	2000
CVC100_09110_□□	1	18	2,8	16	100	2000
CVC150_09110_□□	1,5	16	3,1	22	100	1500
CVC250_09110_□□	2,5	14	3,5	32	100	1000
CVC400_09110_□□	4	12	4,2	48	100	500
CVC600_09110_□□	6	10	4,7	68	100	400
CVCB10_09110_□□	10	8	6,5	119	100	-
CVCB16_09110_□□	16	6	8,2	191	50	-
CVCB25_09110_□□	25	4	9,7	285	50	-
CVCB35_09110_□□	35	2	10,9	383	50	-
CVCB50_09110_□□	50	1	13,7	567	500*	-

Codice - Code	Sezione Size [mm ²]	Sezione Size [AWG/kcmil]	Diametro Diameter [mm]	Peso Weight [kg/km]	Confezione in bobina/matassa Reel/spool packaging [m]	Confezione "Cable Box" Packaging "Cable Box" [m]
CVCB70_09110_□□	70	2/0	15,1	748	500*	-
CVCB95_09110_□□	95	3/0	17,3	1008	500*	-
CVCL12_09110_□□	120	4/0	18,4	1223	500*	-
CVCL15_09110_□□	150	250	20,7	1542	500*	-
CVCL18_09110_□□	185	350	22,5	1862	500*	-
CVCL24_09110_□□	240	450	25,4	2415	500*	-

* Per questo articolo si effettua, su richiesta, un servizio aggiuntivo di taglio a misura certificato UL ("Processed Wire").

* For this article, an additional UL certified cut-to-length service is carried out on request ("Processed Wire").

(1) Questo articolo non è HAR. - This article is not HAR.

Composizione del codice - Code composition

CVC □□□ _09110_ □□ □□□		Imballo Packaging	Inserire To be inserted
Sezione Size	Inserire To be inserted	Bobina/matassa Reel/spool	<lasciare campo vuoto> <keep this field empty>
0,34, 0,5, ..., 6 mm ²	034, 050, ..., 600	"Cable Box"	_CB
10, 16, ..., 95 mm ²	B10, B16, ..., B95	"Cable Box"	
120, 150, ..., 240 mm ²	L12, L15, ..., L24		
Colore Color	Inserire To be inserted		
Arancione - Orange	AR		
Bianco - White	BI		
Bianco/arancione - White/orange	BA**		
Bianco/blu - White/blue**	BB**		
Blu - Blue	BU		
Blu Ral 5015 - Blue Ral 5015	BL		
Giallo - Yellow*	GI*		
Giallo/verde - Yellow/green	GV		
Grigio - Gray	GR		
Marrone - Brown	MR		
Nero - Black	NE		
Rosa - Pink	RS		
Rosso - Red	RO		
Verde - Green*	VE*		
Viola - Violet	VI		

* Per queste colorazioni il prodotto non è HAR.

* For these colors the product is not HAR.

** Per queste colorazioni il prodotto non è HAR per sezioni >1 mm².

** For these colors the product is not HAR for sizes > 1 mm².

Nota. Il doppio colore è tale che uno dei colori copre almeno il 30% e non più del 70% della superficie, l'altro colore copre il resto di tale superficie.

Note. The double color is such that one of the colours covers at least 30% and not more than 70% of the surface, the other colour covering the remainder of that surface.

SERIES
950

Cavi unipolari in silicone e fibra di vetro

Silicone rubber braided glass cables



“UL-CSA Recognized”, posa fissa, non schermati - Fixed application, unshielded

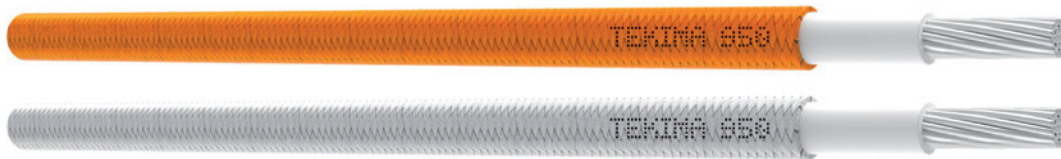

Impiego - Use

Cavo unipolare progettato per il cablaggio di apparecchiature elettriche in cui si ha presenza di umidità, basse temperature o fonti di calore. La gomma siliconica se bruciata produce una cenere non conduttiva che mantiene le proprietà dielettriche, questo consente di eseguire le procedure di arresto dell'apparecchiatura in sicurezza. La guaina esterna in fibra di vetro garantisce una buona resistenza meccanica ed una buona resistenza alla fiamma ed all'umidità.

Single core cable planned for the harness of electrical equipment where there is the presence of humidity, low temperatures or heating sources. The silicone rubber, if burnt, produces a non-conductive ash, maintaining the dielectric properties; this permits to carry out the stop routine of the equipment in safety. The external glass fiber jacket grants a good mechanical, flame and humidity resistance.

Dati tecnici - Technical data

Caratteristica - Characteristics	Valore/proprietà - Value/property
Conduttore <i>Conductor</i>	Trefolo flessibile di rame <i>Flexible copper strand</i>
Isolamento <i>Insulation</i>	Gomma siliconica <i>Silicone rubber</i>
Guaina esterna <i>External jacket</i>	Fibra di vetro <i>Braided glass fiber</i>
Raggio di curvatura <i>Bending radius</i>	8 volte diametro esterno del cavo <i>8 x cable outer diameter</i>
Temperatura di esercizio <i>Temperature range</i>	+150°C/+200°C -60°C
Tensione nominale <i>Voltage rating</i>	600 V

Codifiche e dimensioni - Coding and dimensions

Codice <i>Code</i>	Numero di conduttori <i>Number of conductors</i>	Sezione <i>Size [AWG/kcmil]</i>	Diametro <i>Diameter [mm]</i>	Peso <i>Weight [kg/km]</i>	Tensione <i>Voltage [V]</i>	Corrente <i>Current [A]</i>	Temperatura <i>Temperature [°C]</i>	Style
CVCW18_09500_□□	1	18 AWG	3,1	17,9	600	31	150	3070, 3123
CVCW18_09510_□□	1	18	3,2	17,9	600	32	200	3071, 3172
CVCW16_09500_□□	1	16	3,3	23,8	600	34	150	3070, 3123
CVCW16_09510_□□	1	16	3,5	23,8	600	35	200	3071
CVCW14_09500_□□	1	14	3,7	32,7	600	40	150	3070
CVCW14_09510_□□	1	14	3,7	32,7	600	45	200	3071
CVCW12_09500_□□	1	12	4,2	47,6	600	50	150	3070
CVCW12_09510_□□	1	12	4,2	47,6	600	55	200	3074
CVCW10_09500_□□	1	10	5,7	92,3	600	70	150	3101
CVCW10_09510_□□	1	10	5,5	92,3	600	75	200	3075
CVCW08_09500_□□	1	08	8	133,9	600	95	150	3278
CVCW06_09500_□□	1	06	9,1	208,3	600	130	150	3278
CVCW04_09510_□□	1	04	10,4	305,1	600	180	200	3125
CVCW02_09510_□□	1	02	12,3	446,4	600	240	200	3125
CVCW01_09510_□□	1	01	14,5	538,7	600	280	200	3231
CVCW/1_09510_□□	1	1/0	15,6	662,2	600	325	200	3231
CVCW/2_09510_□□	1	2/0	17	818,5	600	370	200	3231
CVCW/3_09510_□□	1	3/0	18,5	1004,5	600	430	200	3231
CVCW/4_09510_□□	1	4/0	20,3	1235,2	600	510	200	3231
CVCX25_09510_□□	1	250 kcmil	23,4	1398,9	600	706	200	3410
CVCX35_09510_□□	1	350	26,2	1904,8	600	877	200	3410
CVCX50_09510_□□	1	500	30,3	2619,2	600	1103	200	3410

Nota. Verificare la disponibilità delle colorazioni in fase d'ordine.
Remark: verify the availability of colors at the moment of the order.

Composizione del codice - Code composition

CVC							
Sezione <i>Size</i>	Inserire <i>To be inserted</i>	Tipologia <i>Type</i>	Inserire <i>To be inserted</i>	Colore <i>Color</i>	Inserire <i>To be inserted</i>		
1, 2, ..., 22 AWG	W01, W02, ..., W22	150°C	09500	Arancione - <i>Orange</i>	AR		
1/0, ..., 4/0 AWG	W/1, W/2, ..., W/4	200°C	09510	Bianco - <i>White</i>	BI		
				Bianco/blu - <i>White/blue</i>	BB		
				Blu - <i>Blue</i>	BU		
				Giallo - <i>Yellow</i>	GI		
				Giallo/verde - <i>Yellow/green</i>	GV		
				Grigio - <i>Gray</i>	GR		

SERIES
960

Cavi unipolari altamente flessibili per posa mobile

High flexible single core cables for dynamic applications



“UL Recognized”, posa mobile, non schermati - Dynamic application, unshielded



Impiego - Use

Cavi unipolari non schermati per impiego mobile in catene portacavi o su parti di macchine in movimento per distanze fino a 10 m e con tensioni fino a 600 V.

Unshielded single core cables suitable for mobile use in power chains or moving machine parts for travel distances up to 10 m and voltage up to 600V.

Dati tecnici - Technical data

Caratteristica - Characteristics	Valore/proprietà - Value/property
Conduttore <i>Conductor</i>	Trefolo extra flessibile in rame rosso, classe 6 <i>Extra-flexible bare copper strand, class 6</i>
Isolamento <i>Insulation</i>	Mescola di PVC <i>PVC compound</i>
Guaina <i>Jacket</i>	Mescola di PUR. Marcatura metrica. <i>PUR compound. Metric. marking.</i>
Temperatura di esercizio <i>Temperature range</i>	+90°C (IEC), +80°C (UL) -40°C (posa fissa); -5°C (mobile) -40°C (fixed); -5°C (dynamic)
Tensione nominale <i>Voltage rating</i>	600/1000 V (IEC), 1000 V (UL)
Spark test	10000 V
Velocità <i>Speed</i>	300 m/min
Accelerazione <i>Acceleration</i>	30 m/s ²
Raggio di curvatura <i>Bending radius</i>	5 volte diametro esterno del cavo in posa fissa, 8 volte diametro esterno in posa mobile, 12 volte diametro esterno in catena portacavi <i>5 x cable outer diameter for fixed applications, 8 x cable outer diameter for dynamic applications, 12 x cable outer diameter for drag chain applications</i>
Riferimenti normativi costruttivi <i>Standards of construction</i>	UL 758, CSA AWM II A/B, cURus AWM Style 11624 Oil res.: EN 6081 1-1-2 Flame res.: IEC 60332-1-2, UL/CSA FT2 UV res.: UNI EN ISO 4892-3 (colorati/colored), UNI EN ISO 4892-2 (nero/black) Other: 2014/35/EU (Low Voltage Directive)
Riferimenti normativi d'impiego <i>Standards of use</i>	ANSI/NFPA 79, UL 508A, CSA C22.1 (CE Code), CSA C22.2 No.286, Style 11624

Marcatura - Marking

TEKIMA 09600 - CE 1x6 mm² 90°C 600/1000V IEC 60332-1-2 RoHS c(UR)us E314444 AWM Style 11624 1x10 AWG AWM II A/B 80°C 1000V FT2 - (prod. reference) = (metric) =

Codifiche e dimensioni - Coding and dimensions

Codice - Code	Sezione - Size [mm ²]	Sezione - Size [AWG/kcmil]	Diametro - Diameter [mm]	Peso - Weight [kg/km]	Confezione - Packaging [m]
CVC250_09600_□□	2,5	14 AWG	5,7	52	500
CVC400_09600_□□	4	12	6,4	71	500
CVC600_09600_□□	6	10	7	94	500*
CVCB10_09600_□□	10	8	8,3	144	500*
CVCB16_09600_□□	16	6	10,2	225	500*
CVCB25_09600_□□	25	4	11,4	316	500*
CVCB35_09600_□□	35	2	13,4	444	500*
CVCB50_09600_□□	50	1	16,2	641	500*
CVCB70_09600_□□	70	2/0	17,3	864	500*
CVCB95_09600_□□	95	3/0	19,7	1092	500*
CVCL12_09600_□□	120	4/0	21	1320	500*
CVCL15_09600_□□	150	250 kcmil	24,1	1688	500*
CVCL18_09600_□□	185	350	26,1	2041	500*
CVCL24_09600_□□	240	450	29,6	2784	500*

* Per questo articolo si effettua, su richiesta, un servizio aggiuntivo di taglio a misura certificato UL ("Processed Wire").

* For this article, an additional UL certified cut-to-length service is carried out on request ("Processed Wire").

Composizione del codice - Code composition

CVC □□□ _09600_ □□

Sezione Size	Inserire To be inserted
2,5, 4, ..., 6 mm ²	250, 400, ..., 600
10, 16, ..., 95 mm ²	B10, B16, ..., B95
120, 150, ..., 240 mm ²	L12, L15, ..., L24

Colore Color	Inserire To be inserted
Giallo/verde - Yellow/green	GV
Nero - Black	NE

Nota. Il doppio colore è tale che uno dei colori copre almeno il 30% e non più del 70% della superficie, l'altro colore copre il resto di tale superficie.

Note. The double color is such that one of the colours covers at least 30% and not more than 70% of the surface, the other colour covering the remainder of that surface.

**SERIES
960S**

Cavi unipolari altamente flessibili per posa mobile

High flexible single core cables for dynamic applications

“UL Recognized”, posa mobile, schermati - Dynamic application, shielded



Impiego - Use

Cavi unipolari schermati per impiego mobile in catene portacavi o su parti di macchine in movimento per distanze fino a 10 m e con tensioni fino a 600 V.

Shielded single core cables suitable for mobile use in power chains or moving machine parts for travel distances up to 10 m and voltage up to 600V.

Dati tecnici - Technical data

Caratteristica - Characteristics	Valore/proprietà - Value/property
Conduttore <i>Conductor</i>	Trefolo extra flessibile in rame rosso, classe 6 <i>Extra-flexible bare copper strand, class 6</i>
Isolamento <i>Insulation</i>	Mescola di PVC <i>PVC compound</i>
Nastro interno <i>Internal tape</i>	Nastro di tessuto non tessuto <i>Nonwoven tape</i>
Schermatura <i>Shield</i>	Treccia di rame stagnato, ricopertura nom. 85% <i>Tinned copper braid, nom. coverage 85%</i>
Nastro esterno <i>External tape</i>	Nastro di tessuto non tessuto <i>Nonwoven tape</i>
Guaina <i>Jacket</i>	Mescola di PUR. Marcatura metrica. <i>PUR compound. Metric. marking.</i>
Temperatura di esercizio <i>Temperature range</i>	+90°C (IEC), +80°C (UL) -40°C (posa fissa); -5°C (mobile) -40°C (fixed); -5°C (dynamic)
Tensione nominale <i>Voltage rating</i>	600/1000 V (IEC), 1000 V (UL)
Spark test	10000 V
Velocità <i>Speed</i>	300 m/min
Accelerazione <i>Acceleration</i>	30 m/s ²
Raggio di curvatura <i>Bending radius</i>	5 volte diametro esterno del cavo in posa fissa, 8 volte diametro esterno in posa mobile, 12 volte diametro esterno in catena portacavi <i>5 x cable outer diameter for fixed applications, 8 x cable outer diameter for dynamic applications, 12 x cable outer diameter for drag chain applications</i>
Riferimenti normativi costruttivi <i>Standards of construction</i>	UL 758, CSA AWM II A/B, cURus AWM Style 11624 Oil res.: EN 60811-1-2 Flame res.: IEC 60332-1-2, UL/CSA FT2 UV res.: UNI EN ISO 4892-3 (colorati/colored), UNI EN ISO 4892-2 (nero/black) Other: 2014/35/EU (Low Voltage Directive)
Riferimenti normativi d'impiego <i>Standards of use</i>	ANSI/NFPA 79, UL 508A, CSA C22.1 (CE Code), CSA C22.2 No.286, Style 11624

Marcatura - Marking

TEKIMA 0960S - CE 1x6 mm² 90°C 600/1000V IEC 60332-1-2 RoHS c(UR)us E314444 AWM Style 11624 1x10 AWG AWM II A/B 80°C 1000V FT2 - (prod. reference) = (metric) =

Codifiche e dimensioni - Coding and dimensions

Codice - Code	Sezione - Size [mm ²]	Sezione - Size [AWG/kcmil]	Diametro - Diameter [mm]	Peso - Weight [kg/km]	Confezione - Packaging [m]
CVC250_0960S_□□	2,5	14 AWG	6,3	71	500
CVC400_0960S_□□	4	12	7	94	500
CVC600_0960S_□□	6	10	7,6	118	500*
CVCB10_0960S_□□	10	8	8,9	176	500*
CVCB16_0960S_□□	16	6	10,8	265	500*
CVCB25_0960S_□□	25	4	12	362	500*
CVCB35_0960S_□□	35	2	14,2	510	500*
CVCB50_0960S_□□	50	1	17	729	500*
CVCB70_0960S_□□	70	2/0	18,3	972	500*

Codice - Code	Sezione - Size [mm ²]	Sezione - Size [AWG/kcmil]	Diametro - Diameter [mm]	Peso - Weight [kg/km]	Confezione - Packaging [m]
CVCB95_0960S_□□	95	3/0	20,7	1211	500*
CVCL12_0960S_□□	120	4/0	22	1443	500*
CVCL15_0960S_□□	150	250 kcmil	25,1	1836	500*
CVCL18_0960S_□□	185	350	27,1	2205	500*
CVCL24_0960S_□□	240	450	30,4	2987	500*
CVCL30_0960S_□□	300	550	33,8	3528	500*

* Per questo articolo si effettua, su richiesta, un servizio aggiuntivo di taglio a misura certificato UL ("Processed Wire").

* For this article, an additional UL certified cut-to-length service is carried out on request ("Processed Wire").

Composizione del codice - Code composition

CVC	□□□	_0960S_	□□	Colore <i>Color</i>	Inserire <i>To be inserted</i>
Sezione <i>Size</i>				Nero - <i>Black</i>	NE
2,5, 4, ..., 6 mm ²					
10, 16, ..., 95 mm ²					
120, 150, ..., 240 mm ²					
	Inserire <i>To be inserted</i>				
	250, 400, ..., 600				
	B10, B16, ..., B95				
	L12, L15, ..., L24				

**SERIES
1000**

Cavi unipolari tipo THHN MTW

Single core cables type THHN MTW



"UL Listed", posa fissa, non schermati - Fixed application, unshielded



Impiego - Use

Come specificato dal ANSI/NFPA 70 "National Electrical Code" (NEC) i conduttori THHN sono utilizzati principalmente in applicazioni industriali, i conduttori MTW sono utilizzati principalmente per il cablaggio di macchine. Sono realizzati in materiale termoplastico con guaina in Nylon resistenti al calore, all'umidità ed agli olii per applicazioni fino a 600 V.

As specified by ANSI/NFPA 70 "National Electrical Code" (NEC), type THHN wires are used mainly for trade and industrial applications, type MTW wires are used mainly for the machinery wire harness. They are made of thermoplastic material with nylon jacket, resistant to heat, humidity and oils for applications not exceeding 600 V.

Dati tecnici - Technical data

Caratteristica - Characteristics	Valore/proprietà - Value/property
Conduttore <i>Conductor</i>	Rame rosso o stagnato <i>Red or tinned copper</i>
Isolamento <i>Insulation</i>	PVC conforme a UL 1581 <i>PVC according to with UL 1581</i>
Guaina <i>Jacket</i>	Nylon
Temperatura di esercizio <i>Temperature range</i>	+90°C
Tensione nominale <i>Voltage rating</i>	600 V
Riferimenti normativi costruttivi <i>Standards of construction</i>	UL 83, UL 1063
Riferimenti normativi d'impiego <i>Standards of use</i>	ANSI/NFPA 70 (NEC) ANSI/NFPA 79, UL 508a

Codifiche e dimensioni - Coding and dimensions

Codice - Code	Sezione - Size [AWG/kcmil]	Sezione - Size [mm ²]	Diametro - Diameter [mm]	Peso - Weight [kg/km]
CVCW18_10000_□□ ⁽¹⁾	18 AWG	0,82	2,23	6
CVCW16_10000_□□ ⁽¹⁾	16	1,31	2,6	17
CVCW14_10000_□□	14	2,08	3,0	25
CVCW12_10000_□□	12	3,31	3,5	37
CVCW10_10000_□□	10	5,26	4,3	60
CVCW08_10000_□□	8	8,37	5,8	95
CVCW06_10000_□□	6	13,3	6,7	143
CVCW04_10000_□□	4	21,2	8,5	229
CVCW02_10000_□□	2	33,6	10,0	349
CVCW01_10000_□□	1	42,4	11,2	451
CVCW/1_10000_□□	1/0	53,5	12,2	560
CVCW/2_10000_□□	2/0	67,4	13,5	695
CVCW/3_10000_□□	3/0	85,0	14,7	865
CVCW/4_10000_□□	4/0	107	16,0	1077
CVCX25_10000_NE	250 kcmil	127	18,3	1347
CVCX30_10000_NE	300	152	19,6	1577
CVCX35_10000_NE	350	177	21,1	1823
CVCX40_10000_NE	400	203	22,1	2053
CVCX50_10000_NE	500	253	24,4	2567
CVCX60_10000_NE	600	304	26,9	3110
CVCX75_10000_NE	750	380	29,7	3839
CVCY10_10000_NE	1000	507	33,5	5104

(1) Non THHN, solo MTW.

(1) Not THHN listed, only MTW.

Composizione del codice - Code composition

CVC		_10000_			
Sezione <i>Size</i>	Inserire <i>To be inserted</i>	Colore <i>Color</i>	Inserire <i>To be inserted</i>	Colore <i>Color</i>	Inserire <i>To be inserted</i>
1, 2, ..., 18 AWG	W01, W02, ..., W18	Arancione - <i>Orange</i>	AR	Marrone - <i>Brown</i>	MR
1/0, ..., 4/0 AWG	W/1, W/2, ..., W/4	Bianco - <i>White</i>	BI	Nero - <i>Black</i>	NE
250, 300, ..., 750 kcmil	X25, X30, ..., X75	Bianco/blu - <i>White/blue</i>	BB	Rosa - <i>Pink</i>	RS
1000 kcmil	Y10	Blu - <i>Blue</i>	BU	Rosso - <i>Red</i>	RO
		Giallo - <i>Yellow</i>	GI	Verde - <i>Green</i>	VE
		Giallo/verde - <i>Yellow/green</i>	GV	Viola - <i>Violet</i>	VI
		Grigio - <i>Gray</i>	GR		

**SERIES
1010S**

Cavi unipolari tipo XHHW-2

Single core cable type XHHW-2

“UL Listed”, posa fissa, schermati – Fixed application, shielded



Impiego - Use

Come specificato dal ANSI/NFPA 70 “National Electrical Code” (NEC) i conduttori XHHW-2 sono utilizzati in applicazioni residenziali, commerciali ed industriali anche in ambienti in presenza di acqua in accordo all’articolo 310. Sono realizzati con isolamento in XLPE e possono essere impiegati per posa fissa o posa mobile occasionale per tensioni fino a 600 V e temperature di 90°C.

As specified by ANSI/NFPA 70 “National Electrical Code” (NEC), type XHHW-2 wires are used for residential, commercial and industrial applications even in wet locations according to Art. 310. They are made of XLPE insulation material and they can be used for fixed or occasional mobile applications up to 600 V and 90°C.

Dati tecnici - Technical data

Caratteristica - Characteristics	Valore/proprietà - Value/property
Conduttore <i>Conductor</i>	Trefolo extra flessibile in rame rosso, classe 5 <i>Extra-flexible bare copper strand, class 5</i>
Isolamento <i>Insulation</i>	XLPE
Nastro interno <i>Internal tape</i>	Nastro di poliestere <i>Polyester tape</i>
Schermatura <i>Shield</i>	Treccia di rame stagnato, ricopertura nom. 85% <i>Tinned copper braid, nom. coverage 85%</i>
Guaina <i>Jacket</i>	Mescola di PVC. Marcatura metrica. <i>PVC compound. Metric. marking.</i>
Temperatura di esercizio <i>Temperature range</i>	+90°C -40°C (posa fissa); -15°C (mobile) -40°C (fixed); -15°C (not fixed)
Tensione nominale <i>Voltage rating</i>	600/1000 V (IEC), 600 V (UL)
Spark test	6000 V
Raggio di curvatura <i>Bending radius</i>	4 volte diametro esterno del cavo (13 volte diametro esterno del cavo per movimentazioni non continue) <i>4 x cable outer diameter (13 x cable outer diameter for non-cyclical mobile uses)</i>
Riferimenti normativi costruttivi <i>Standards of construction</i>	UL 44, Nec Art. 310 I Oil res.: UL 83, UL 1063 I Flame res.: Test B acc. to DIN 0472 part 804, UL FT1 I Other: 2014/35/EU (Low Voltage Directive)
Riferimenti normativi d’impiego <i>Standards of use</i>	ANSI/NFPA 70 (NEC), ANSI/NFPA 79

Marcatura - Marking

TEKIMA 1010S – CE 1x2,5 mm² 600/1000V RoHS (UL) E501777 XHHW-2 1x14 AWG 90°C 1000V FT1 – (prod.reference) = (metric) =

Codifiche e dimensioni - Coding and dimensions

Codice - Code	Sezione - Size [mm ²]	Sezione - Size [AWG/kcmil]	Diametro - Diameter [mm]	Peso - Weight [kg/km]	Confezione - Packaging [m]
CVC250_1010S_□□	2,5	14 AWG	5,8	62	500
CVC400_1010S_□□	4	12	6,5	83	500
CVC600_1010S_□□	6	10	7	104	500*
CVCB10_1010S_□□	10	8	8,6	161	500*
CVCB16_1010S_□□	16	6	9,8	228	500*
CVCB25_1010S_□□	25	4	12,1	348	500*
CVCB35_1010S_□□	35	2	13,5	458	500*
CVCB50_1010S_□□	50	1	16,2	659	500*
CVCB70_1010S_□□	70	2/0	17,8	858	500*
CVCB95_1010S_□□	95	3/0	20,8	1161	500*
CVCL12_1010S_□□	120	4/0	22,1	1402	500*
CVCL15_1010S_□□	150	250 kcmil	24,3	1725	500*
CVCL18_1010S_□□	185	350	26,9	2103	500*
CVCL24_1010S_□□	240	450	30,2	2692	500*
CVCL30_1010S_□□	300	550	32,7	3289	500*

* Per questo articolo si effettua, su richiesta, un servizio aggiuntivo di taglio a misura certificato UL (“Processed Wire”).

* For this article, an additional UL certified cut-to-length service is carried out on request (“Processed Wire”).

Composizione del codice - Code composition

CVC	□□□	_1010S_	□□	Colore <i>Color</i>	Inserire <i>To be inserted</i>
Sezione <i>Size</i>				Nero - <i>Black</i>	NE
2,5, 4, ..., 6 mm ²					
10, 16, ..., 95 mm ²					
120, 150, ..., 300 mm ²					
	Inserire <i>To be inserted</i>				
	250, 400, ..., 600				
	B10, B16, ..., B95				
	L12, L15, ..., L30				

**SERIES
1050**

Cavi unipolari Style 1032

Single core cables Style 1032



“UL Recognized”, posa fissa, non schermati - Fixed application, unshielded



Impiego - Use

Cavi unipolari non schermati resistenti agli olii impiegati su macchine utensili e soggetti a sollecitazioni meccaniche di media intensità e per tensioni fino a 1000V. Sono adatti per posa fissa o per posa mobile non ciclica con movimenti non abbinati a sollecitazioni di trazione anche in presenza di umidità.

Oil resistant unshielded single core cables suitable for machine tools subjected to medium mechanical stresses up to 1000V. They can be used for fixed or flexible installation, where free movement is required without tensile stresses and without forced guidance systems in dry, damp and wet interiors.

Dati tecnici - Technical data

Caratteristica - Characteristics	Valore/proprietà - Value/property
Conduttore <i>Conductor</i>	Trefolo flessibile in rame rosso, classe 5 <i>Flexible bare copper strand, class 5</i>
Isolamento <i>Insulation</i>	Mescola di PVC <i>PVC compound</i>
Guaina <i>Jacket</i>	Mescola di PVC <i>PVC compound</i>
Temperatura di esercizio <i>Temperature range</i>	+90°C -40°C (posa fissa); -5°C (mobile) -40°C (fixed); -5°C (not fixed)
Tensione nominale <i>Voltage rating</i>	1000 V (UL-CSA), 600/1000 V (IEC)
Spark test	10000 V
Raggio di curvatura <i>Bending radius</i>	4 volte diametro esterno del cavo (13 volte diametro esterno del cavo per movimentazioni non continue) <i>4 x cable outer diameter (13 x cable outer diameter for non-cyclical mobile uses)</i>
Riferimenti normativi costruttivi <i>Standards of construction</i>	UL 758 Flame res.: Test B acc. to DIN VDE 0472 part 804, IEC 60332-1-2, IEC 60332-3-24, UL 1581 sec. 1080 VW-1, CSA C22.2 No.2556 FT1 Oil res.: DIN EN 50290-2-22, VDE 0819-102 Other: CSA AWM I A/B, cURus AWM Style 1032
Riferimenti normativi d'impiego <i>Standards of use</i>	ANSI/NFPA 79, UL 508A, CSA C22.1 (CE Code), CSA C22.2 No.286, Style 1032

Marcatura - Marking

TEKIMA 10500 – CE 4 mm² 600/1000V 90°C IEC 60332-1-2 c(UR)us AWM Style 1032 E314444 12 AWG 1000V 90°C VW-1 AWM I A/B 90°C 1000V FT1 – (prod. reference) = (metric) =

Codifiche e dimensioni - Coding and dimensions

Codice - Code	Sezione - Size [mm ²]	Sezione - Size [AWG/kcmil]	Diametro - Diameter [mm]	Peso - Weight [kg/km]	Confezione - Packaging [m]
CVC250_10500_□□	2,5	14 AWG	6,0	60	1000
CVC400_10500_□□	4	12	6,6	79	1000
CVC600_10500_□□	6	10	7,2	104	1000*
CVCB10_10500_□□	10	8	8,9	165	500*
CVCB16_10500_□□	16	6	9,9	251	500*
CVCB25_10500_□□	25	4	11,4	345	500*
CVCB35_10500_□□	35	2	13,9	478	500*
CVCB50_10500_□□	50	1	15,6	697	500*
CVCB70_10500_□□	70	2/0	17,7	939	500*
CVCB95_10500_□□	95	3/0	19,2	1172	500*
CVCL12_10500_□□	120	4/0	22,0	1407	500*
CVCL15_10500_□□	150	250 kcmil	23,6	1774	500*
CVCL18_10500_□□	185	350	26,2	2136	500*
CVCL24_10500_□□	240	450	31,0	2907	500*
CVCL30_10500_□□	300	550	34,7	3630	500*

* Per questo articolo si effettua, su richiesta, un servizio aggiuntivo di taglio a misura certificato UL ("Processed Wire").

* For this article, an additional UL certified cut-to-length service is carried out on request ("Processed Wire").

Composizione del codice - Code composition

CVC	□□□	_10500_	□□
Sezione - Size	Inserire - To be inserted		
2,5, 4, ..., 6 mm ²	250, 400, ..., 600		
10, 16, ..., 95 mm ²	B10, B16, ..., B95		
120, 150, ..., 300 mm ²	L12, L15, ..., L30		

Colore <i>Color</i>	Inserire <i>To be inserted</i>
Giallo/verde - Yellow/green	GV
Nero - Black	NE

Nota. Il doppio colore è tale che uno dei colori copre almeno il 30% e non più del 70% della superficie, l'altro colore copre il resto di tale superficie.

Note. The double color is such that one of the colours covers at least 30% and not more than 70% of the surface, the other colour covering the remainder of that surface.

**SERIES
1050S**

Cavi unipolari Style 1032

Single core cables Style 1032



“UL Recognized”, posa fissa, schermati - Fixed application, shielded



Impiego - Use

Cavi unipolari schermati resistenti agli olii impiegati su macchine utensili e soggetti a sollecitazioni meccaniche di media intensità e per tensioni fino a 1000V. Sono adatti per posa fissa o per posa mobile non ciclica con movimenti non abbinati a sollecitazioni di trazione anche in presenza di umidità.

Oil resistant shielded single core cables suitable for machine tools subjected to medium mechanical stresses up to 1000V. They can be used for fixed or flexible installation, where free movement is required without tensile stresses and without forced guidance systems in dry, damp and wet interiors.

Dati tecnici - Technical data

Caratteristica - Characteristics	Valore/proprietà - Value/property
Conduttore Conductor	Trefolo flessibile in rame rosso, classe 5 Flexible bare copper strand, class 5
Isolamento Insulation	Mescola di PVC PVC compound
Nastro interno Internal tape	Nastro di poliestere Polyester tape
Schermatura Shield	Treccia di rame stagnato, ricopertura nom. 85% Tinned copper braid, coverage 85%
Guaina Jacket	Mescola di PVC PVC compound
Temperatura di esercizio Temperature range	+90°C -40°C (posa fissa); -5°C (mobile) -40°C (fixed); -5°C (not fixed)
Tensione nominale Voltage rating	1000 V (UL-CSA), 600/1000 V (IEC)
Spark test	10000 V
Raggio di curvatura Bending radius	4 volte diametro esterno del cavo (13 volte diametro esterno del cavo per movimentazioni non continue) 4 x cable outer diameter (13 x cable outer diameter for non-cyclical mobile uses)
Riferimenti normativi costruttivi Standards of construction	UL 758 I Flame res.: Test B acc. to DIN VDE 0472 part 804, IEC 60332-1-2, IEC 60332-3-24, UL 1581 sec. 1080 VW-1, CSA C22.2 No.2556 FT1 I Oil res.: DIN EN 50290-2-22, VDE 0819-102 I Other: CSA AWM I A/B, cURus AWM Style 1032
Riferimenti normativi d'impiego Standards of use	ANSI/NFPA 79, UL 508A, CSA C22.1 (CE Code), CSA C22.2 No.286, Style 1032

Marcatura - Marking

TEKIMA 1050S – CE 4 mm² 600/1000V 90°C IEC 60332-1-2 c(UR)us AWM Style 1032 E314444 12 AWG 1000V 90°C AWM I A/B 90°C 1000V FT1 – (prod. reference) = (metric) =

Codifiche e dimensioni - Coding and dimensions

Codice - Code	Sezione - Size [mm ²]	Sezione - Size [AWG/kcmil]	Diametro - Diameter [mm]	Peso - Weight [kg/km]	Confezione - Packaging [m]
CVC250_1050S_□□	2,5	14 AWG	6,6	81	1000
CVC400_1050S_□□	4	12	7,2	104	1000
CVC600_1050S_□□	6	10	7,9	133	1000*
CVCB10_1050S_□□	10	8	9,6	202	500*
CVCB16_1050S_□□	16	6	11,5	296	500*
CVCB25_1050S_□□	25	4	12,7	396	500*
CVCB35_1050S_□□	35	2	15,1	562	500*
CVCB50_1050S_□□	50	1	18,2	799	500*
CVCB70_1050S_□□	70	2/0	20,7	1065	500*
CVCB95_1050S_□□	95	3/0	21,7	1290	500*
CVCL12_1050S_□□	120	4/0	23,0	1534	500*
CVCL15_1050S_□□	150	250 kcmil	25,8	1917	500*
CVCL18_1050S_□□	185	350	28,0	2310	500*
CVCL24_1050S_□□	240	450	33,8	3166	500*
CVCL30_1050S_□□	300	550	37,4	3924	500*

* Per questo articolo si effettua, su richiesta, un servizio aggiuntivo di taglio a misura certificato UL ("Processed Wire").

* For this article, an additional UL certified cut-to-length service is carried out on request ("Processed Wire").

Composizione del codice - Code composition

CVC □□□ _1050S_ □□	Colore Color	Inserire To be inserted
	Nero - Black	NE
Sezione - Size	Inserire - To be inserted	
2,5, 4, ..., 6 mm ²	250, 400, ..., 600	
10, 16, ..., 95 mm ²	B10, B16, ..., B95	
120, 150, ..., 300 mm ²	L12, L15, ..., L30	

**SERIES
1060**

Cavi unipolari tipo THHW/TFF MTW

Single core cables type THHW/TFF MTW

“UL Listed”, posa fissa, non schermati - Fixed application, unshielded



<HAR>



Impiego - Use

Cavi unipolari resistenti agli olii impiegati su macchine utensili e soggetti a sollecitazioni meccaniche di media intensità. Sono adatti per posa fissa o per posa mobile non ciclica con movimenti non abbinati a sollecitazioni di trazione. I cavi unipolari THHW/TFF MTW sono in accordo a ANSI/NFPA 79 e l'articolo 336.10 (7) del ANSI/NFPA 70 “National Electrical Code” (NEC).

Oil resistant single core cables suitable for machine tools subjected to medium mechanical stresses, for fixed or flexible installation, where free movement is required without tensile stresses and without forced guidance systems. The THHW/TFF MTW single core cables are in accordance with the ANSI/NFPA 79 and ANSI/NFPA 70 “National Electrical Code” (NEC) Art. 336.10 (7).

Dati tecnici - Technical data

Caratteristica - Characteristics	Valore/proprietà - Value/property
Conduttore <i>Conductor</i>	Trefolo flessibile in rame rosso, classe 5 <i>Flexible bare copper strand, class 5</i>
Isolamento <i>Insulation</i>	Mescola di PVC <i>PVC compound</i>
Temperatura di esercizio <i>Temperature range</i>	+90°C (UL), +70°C (HAR) -40°C (posa fissa); -5°C (mobile) -40°C (fixed); -5°C (not fixed)
Tensione nominale <i>Voltage rating</i>	600 V (UL-CSA), 300/500 V (IEC, ≤1 mm ²), 450/750 V (IEC, >1 mm ²)
Spark test	6000 V
Raggio di curvatura <i>Bending radius</i>	4 volte diametro esterno del cavo (13 volte diametro esterno del cavo per movimentazioni non continue) <i>4 x cable outer diameter (13 x cable outer diameter for non-cyclical mobile uses)</i>
Riferimenti normativi costruttivi <i>Standards of construction</i>	Nec Art. 336.10 (7) - Oil res.: UL 1277, UL 1063, TFF (≤1,5 mm ²) / THHW (≥2,5 mm ²) Flame res.: Test B acc. to DIN VDE 0472 part 804, IEC 60332-1-2, UL/CSA FT1 Other: CEI EN 50525-2-31 and HD 21.3 S3:1995+A1:1999+A2:2008, CSA AWM I A/B, cURus AWM Style 1015
Riferimenti normativi d'impiego <i>Standards of use</i>	ANSI/NFPA 70 (NEC), ANSI/NFPA 79, UL 508a, CSA C22.1 (CE Code), CSA C22.2 No.286, Style 1015

Marcatura - Marking

TEKIMA 10600 – CE H07V-K IEMMEQU <HAR> 1x2,5 mm² 450/750V IEC 60332-1-2 RoHS (UL) E361260 MTW 1x14 AWG 600V THHW or AWM Style 1015 c(UR) AWM I A/B 600V 90°C FT1 14 AWG – (prod.reference) = (metric) =

Codifiche e dimensioni - Coding and dimensions

Codice - Code	Sezione - Size [mm ²]	Sezione - Size [AWG/kcmil]	Diametro - Diameter [mm]	Peso - Weight [kg/km]	Confezione - Packaging [m]
CVC100_10600_□□	1	18 AWG	2,9	16,4	1000
CVC150_10600_□□	1,5	16	3,2	22,5	1000
CVC250_10600_□□	2,5	14	3,6	33	1000
CVC400_10600_□□	4	12	4,3	49	1000
CVC600_10600_□□	6	10	4,8	69	1000*
CVCB10_10600_□□	10	8	6,5	118	500*
CVCB16_10600_□□	16	6	8,3	191	500*
CVCB25_10600_□□	25	4	9,8	284	500*
CVCB35_10600_□□	35	2	11	382	500*
CVCB50_10600_□□	50	1	13,7	564	500*
CVCB70_10600_□□	70	2/0	15,8	774	500*
CVCB95_10600_□□	95	3/0	17,3	1003	500*
CVCL12_10600_□□	120	4/0	18,4	1221	500*

Codice - Code	Sezione - Size [mm ²]	Sezione - Size [AWG/kcmil]	Diametro - Diameter [mm]	Peso - Weight [kg/km]	Confezione - Packaging [m]
CVCL15_10600_□□	150	250 kcmil	20,8	1537	500*
CVCL18_10600_□□	185	350	22,6	1869	500*
CVCL24_10600_□□	240	450	27,4	2528	500*

* Per questo articolo si effettua, su richiesta, un servizio aggiuntivo di taglio a misura certificato UL ("Processed Wire").

* For this article, an additional UL certified cut-to-length service is carried out on request ("Processed Wire").

Composizione del codice - Code composition

CVC □□□ _10600_ □□

Sezione Size	Inserire To be inserted
1, 1,5, ..., 6 mm ²	100, 150, ..., 600
10, 16, ..., 95 mm ²	B10, B16, ..., B95
120, 150, ..., 240 mm ²	L12, L15, ..., L24

Colore Color	Inserire To be inserted
Giallo/verde - Yellow/green	GV
Grigio - Gray	GR
Marrone - Brown	MR
Nero - Black	NE

Nota. Il doppio colore è tale che uno dei colori copre almeno il 30% e non più del 70% della superficie, l'altro colore copre il resto di tale superficie.

Note. The double color is such that one of the colours covers at least 30% and not more than 70% of the surface, the other colour covering the remainder of that surface.

**SERIES
1070**

Cavi unipolari tipo THHW/TFF MTW AWM TEW

Single core cables type THHW/TFF MTW AWM TEW



“UL Listed”, posa fissa, non schermati - Fixed application, unshielded



<HAR>



Impiego - Use

Cavi unipolari resistenti agli olii impiegati su macchine utensili e soggetti a sollecitazioni meccaniche di media intensità. Sono adatti per posa fissa o per posa mobile non ciclica con movimenti non abbinati a sollecitazioni di trazione. I cavi unipolari THHW/TFF MTW sono in accordo a ANSI/NFPA 79 e gli articoli 310 e 402 del ANSI/NFPA 70 “National Electrical Code” (NEC).

Oil resistant single core cables suitable for machine tools subjected to medium mechanical stresses, for fixed or flexible installation, where free movement is required without tensile stresses and without forced guidance systems. The THHW/TFF MTW single core cables are in accordance with the ANSI/NFPA 79 and ANSI/NFPA 70 “National Electrical Code” (NEC) Art. 310 and 402.

Dati tecnici - Technical data

Caratteristica - Characteristics	Valore/proprietà - Value/property
Conduttore <i>Conductor</i>	Trefolo flessibile in rame rosso, classe 5 <i>Flexible bare copper strand, class 5</i>
Isolamento <i>Insulation</i>	Mescola di PVC <i>PVC compound</i>
Temperatura di esercizio <i>Temperature range</i>	+90°C (MTW), +105°C (AWM/TEW), +90°C (IEC), +90°C (HAR H05V2-K/H07V2-K <50 mm ²), +70°C (HAR H07V-K ≥50 mm ²) -40°C (posa fissa); -5°C (mobile) -40°C (fixed); -5°C (not fixed)
Tensione nominale <i>Voltage rating</i>	1000 V (AWM), 600 V (MTW), 300/500 V (IEC/HAR H05V2-K ≤1 mm ²), 450/750 V (IEC/HAR H07V2-K/ H07V-K >1 mm ²)
Spark test	6000 V
Raggio di curvatura <i>Bending radius</i>	4 volte diametro esterno del cavo (13 volte diametro esterno del cavo per movimentazioni non continue) <i>4 x cable outer diameter (13 x cable outer diameter for non-cyclical mobile uses)</i>
Riferimenti normativi costruttivi <i>Standards of construction</i>	Nec Art. 310, 402 - Oil res.: UL 1277, UL 1063, TFF (≤1,5 mm ²) / THHW (≥2,5 mm ²), TEW (≤4/0 AWG) I Flame res.: Test B acc. to DIN VDE 0472 part 804, IEC 60332- 1-2, UL/CSA FT1, Other: CEI EN 50525-2-31 and HD 21.3 S3:1995+A1:1999+A2:2008, CSA AWM I A/B TEW, cURus AWM Style 10269, MTW
Riferimenti normativi d'impiego <i>Standards of use</i>	ANSI/NFPA 70 (NEC), ANSI/NFPA 79, UL 508a, CSA C22.1 (CE Code), CSA C22.2 No.286, Style 10269

Marcatura - Marking

TEKIMA 10700 – H07V2-K IEMMEQU <HAR> 90°C CE 1x2,5 mm² 90°C 450/750V IEC 60332-1-2 RoHS (UL) E361260 MTW 1x14 AWG 600V or THHW or AWM Style 10269 c(UR) AWM I A/B 1000V or TEW 105°C 600V FT1 14 AWG – (prod.reference) = (metric) =

Codifiche e dimensioni - Coding and dimensions

Codice - Code	Sezione - Size [mm ²]	Sezione - Size [AWG/kcmil]	Diametro - Diameter [mm]	Peso - Weight [kg/km]	Confezione - Packaging [m]
CVC034_10700_□□ ⁽¹⁾	0,34	22 AWG	2,3	8	500
CVC050_10700_□□ ⁽²⁾	0,5	21	2,5	11	500
CVC075_10700_□□ ⁽²⁾	0,75	19	2,7	14	100
CVC100_10700_□□	1	18	2,9	16,4	100
CVC150_10700_□□	1,5	16	3,2	22,5	100
CVC250_10700_□□	2,5	14	3,6	33	100
CVC400_10700_□□	4	12	4,3	49	100
CVC600_10700_□□	6	10	4,8	69	100
CVCB10_10700_□□	10	8	6,5	118	100
CVCB16_10700_□□	16	6	8,3	191	50
CVCB25_10700_□□	25	4	9,8	284	500*
CVCB35_10700_□□	35	2	11	382	500*
CVCB50_10700_□□	50	1	13,7	564	500*
CVCB70_10700_□□	70	2/0	15,8	774	500*
CVCB95_10700_□□	95	3/0	17,3	1003	500*

Codice - Code	Sezione - Size [mm ²]	Sezione - Size [AWG/kcmil]	Diametro - Diameter [mm]	Peso - Weight [kg/km]	Confezione - Packaging [m]
CVCL12_10700_□□	120	4/0	18,4	1221	500*
CVCL15_10700_□□	150	250 kcmil	20,8	1537	500*
CVCL18_10700_□□	185	350	22,6	1869	500*
CVCL24_10700_□□	240	450	27,4	2528	500*

* Per questo articolo si effettua, su richiesta, un servizio aggiuntivo di taglio a misura certificato UL ("Processed Wire").

* For this article, an additional UL certified cut-to-length service is carried out on request ("Processed Wire").

(1) Questo articolo non è HAR e non è THHW/TFF. - This article is not HAR and is not THHW/TFF.

(2) Questo articolo non è THHW/TFF. - This article is not THHW/TFF.

Composizione del codice - Code composition

CVC	□□□	_10700_	□□	Colore Color	Inserire To be inserted
Sezione Size	Inserire To be inserted				
1, 1,5, ..., 6 mm ²	100, 150, ..., 600				
10, 16, ..., 95 mm ²	B10, B16, ..., B95				
120, 150, ..., 240 mm ²	L12, L15, ..., L24				
		Arancione - Orange	AR		
		Bianco/arancione - White/orange**	BA**		
		Bianco - White	BI		
		Bianco/blu - White/blue**	BB**		
		Bianco/giallo - White/yellow**	BG**		
		Blu - Blue	BU		
		Giallo - Yellow*	GI*		
		Giallo/verde - Yellow/green	GV		
		Grigio - Gray	GR		
		Marrone - Brown	MR		
		Nero - Black	NE		
		Rosa - Pink	RS		
		Rosso - Red	RO		
		Verde - Green*	VE*		

* Per queste colorazioni il prodotto non è HAR.

* For these colors the product is not HAR.

** Per queste colorazioni il prodotto non è HAR per sezioni >1 mm².

** For these colors the product is not HAR for sizes > 1 mm².

Nota. Il doppio colore è tale che uno dei colori copre almeno il 30% e non più del 70% della superficie, l'altro colore copre il resto di tale superficie.

Note. The double color is such that one of the colours covers at least 30% and not more than 70% of the surface, the other colour covering the remainder of that surface.

SERIES
1075

Cavi unipolari tipo THHW MTW AWM TEW per posa mobile



Single core cables type THHW MTW AWM TEW for dynamic applications

“UL Listed”, posa mobile, non schermati - Dynamic application, unshielded



<HAR>



Impiego - Use

Cavi unipolari per impiego mobile in catene portacavi o su parti di macchine in movimento per distanze fino a 10 m. I cavi unipolari THHW/TFF MTW sono in accordo a ANSI/NFPA 79 e agli articoli 310, 610 e 620 del ANSI/NFPA 70 “National Electrical Code” (NEC).

Single core cables suitable for mobile use in power chains or moving machine parts for travel distances up to 10 m. The THHW MTW single core cables are in accordance with the ANSI/NFPA 79 and ANSI/NFPA 70 “National Electrical Code” (NEC) Art. 310, 610 and 620.

Dati tecnici - Technical data

Caratteristica - Characteristics	Valore/proprietà - Value/property
Conduttore Conductor	Trefolo extra flessibile in rame rosso, classe 6 Extra-flexible bare copper strand, class 6
Isolamento Insulation	Mescola di PVC PVC compound
Temperatura di esercizio Temperature range	+90°C (MTW), +105°C (AWM/TEW), +90°C (IEC), +90°C (HAR H05V2-K/H07V2-K <50 mm ²), +70°C (HAR H07V-K ≥50 mm ²) -40°C (posa fissa); -5°C (mobile) -40°C (fixed); -5°C (dynamic)
Tensione nominale Voltage rating	1000 V (AWM), 600 V (MTW), 300/500 V (IEC/HAR H05V2-K ≤1 mm ²), 450/750 V (IEC/HAR H07V2-K/H07V-K >1 mm ²)
Spark test	10000 V
Velocità Speed	180 m/min
Accelerazione Acceleration	20 m/s ²
Raggio di curvatura Bending radius	8 volte diametro esterno del cavo in posa fissa, 12 volte diametro esterno in posa mobile, 15 volte diametro esterno in catena portacavi 8 x cable outer diameter for fixed applications, 12 x cable outer diameter for dynamic applications, 15 x cable outer diameter for drag chain applications
Riferimenti normativi costruttivi Standards of construction	Nec Art. 310, 402 - Oil res.: UL 1277, UL 1063, TFF (≤1,5 mm ²) / THHW (≥2,5 mm ²), TEW (≤4/0 AWG) Flame res.: Test B acc. to DIN VDE 0472 part 804, IEC 60332-1-2, UL/CSA FT1, Other: CEI EN 50525-2-31 and HD 21.3 S3:1995+A1:1999+A2:2008, CSA AWM I A/B TEW, cURus AWM Style 10269, MTW
Riferimenti normativi d'impiego Standards of use	ANSI/NFPA 70 (NEC), ANSI/NFPA 79, UL 508a, CSA C22.1 (CE Code), CSA C22.2 No.286, Style 10269

Marcatura - Marking

TEKIMA 10750 – H07V2-K IEMMEQU <HAR> 90°C CE 1x2,5 mm² 90°C 450/750V IEC 60332-1-2 RoHS (UL) E361260 MTW 1x14 AWG 600V or THHW or AWM Style 10269 c(UR) AWM I A/B 1000V or TEW 105°C 600V FT1 14 AWG – (prod.reference) = (metric) =

Codifiche e dimensioni - Coding and dimensions

Codice - Code	Sezione - Size [mm ²]	Sezione - Size [AWG/kcmil]	Diametro - Diameter [mm]	Peso - Weight [kg/km]	Confezione - Packaging [m]
CVC150_10750_□□	1,5	16 AWG	3,2	23	1000
CVC250_10750_□□	2,5	14	4,2	33	1000
CVC400_10750_□□	4	12	4,3	49	1000
CVC600_10750_□□	6	10	4,9	69	1000*
CVCB10_10750_□□	10	8	6,7	118	500*
CVCB16_10750_□□	16	6	8,5	191	500*
CVCB25_10750_□□	25	4	9,7	284	500*
CVCB35_10750_□□	35	2	11,5	382	500*
CVCB50_10750_□□	50	1	14,3	564	500*
CVCB70_10750_□□	70	2/0	16,4	774	500*
CVCB95_10750_□□	95	3/0	17,4	1003	500*

Codice - Code	Sezione - Size [mm ²]	Sezione - Size [AWG/kcmil]	Diametro - Diameter [mm]	Peso - Weight [kg/km]	Confezione - Packaging [m]
CVCL12_10750_□□	120	4/0	18,5	1221	500*
CVCL15_10750_□□	150	250 kcmil	20,8	1537	500*
CVCL18_10750_□□	185	350	22,6	1869	500*
CVCL24_10750_□□	240	450	25,5	2528	500*

* Per questo articolo si effettua, su richiesta, un servizio aggiuntivo di taglio a misura certificato UL ("Processed Wire").

* For this article, an additional UL certified cut-to-length service is carried out on request ("Processed Wire").

Composizione del codice - Code composition

Sezione Size	Inserire To be inserted	Colore Color	Inserire To be inserted
1,5, 2,5, ..., 6 mm ²	150, 250, ..., 600	Giallo/verde - Yellow/green	GV
10, 16, ..., 95 mm ²	B10, B16, ..., B95	Nero - Black	NE
120, 150, ..., 240 mm ²	L12, L15, ..., L24		

Nota. Il doppio colore è tale che uno dei colori copre almeno il 30% e non più del 70% della superficie, l'altro colore copre il resto di tale superficie.

Note. The double color is such that one of the colours covers at least 30% and not more than 70% of the surface, the other colour covering the remainder of that surface.



Cavi multipolari per posa fissa

Cables for
fixed applications

**SERIES
50**

Cavi "LiYY" per trasmissione dati

"LiYY" data transmission cables

**Posa fissa, non schermati - Fixed application, unshielded**

Impiego - Use

Sono cavi per segnale e controllo costruiti per applicazioni industriali di trasmissione segnali e bus caratterizzati da movimenti scarsamente ripetitivi e che utilizzano lo standard di colorazione DIN 47100.

These are communication and control cables for mobile use with scarcely repetitive movements and designed for general purpose installation in industrial signal and bus applications that utilize the DIN 47100 color code.

Informazione. Si effettua, su richiesta, un servizio aggiuntivo di taglio a misura.
Information. An additional cut-to-length service is carried out on request.

Dati tecnici - Technical data

Caratteristica - Characteristics	Valore/proprietà - Value/property
Conduttore <i>Conductor</i>	Trefolo flessibile in rame, classe 5 <i>Flexible copper strand, class 5</i>
Isolamento <i>Insulation</i>	Mescola di PVC <i>PVC compound</i>
Distinzione conduttori <i>Conductor distinction</i>	In accordo allo standard DIN 47100 <i>According to DIN 47100 Standard</i>
Guaina <i>Jacket</i>	Mescola di PVC, colore grigio RAL 7001. Marcatura metrica <i>PVC compound, RAL 7001 gray color. Metric marking</i>
Temperatura di esercizio <i>Temperature range</i>	-40°C, +80°C (posa fissa); -5°C, +70°C (mobile occasionale) <i>-40°C, +80°C (fixed); -5°C, +70°C (not fixed)</i>
Tensione nominale <i>Voltage rating</i>	300/300 V ($\leq 0,34 \text{ mm}^2$) 300/500 V ($> 0,34 \text{ mm}^2$)
Tensione di prova <i>Test voltage</i>	3000 V
Capacità <i>Capacitance</i>	0,14 mm ² : 120 nF/km; >0,14 mm ² : 150 nF/km
Induttanza lineare <i>Linear inductance</i>	approx. 0,65 mH/km
Raggio di curvatura <i>Bending radius</i>	4 volte diametro esterno del cavo (posa fissa) 15 volte diametro esterno del cavo (posa mobile non ciclica) <i>4 x cable outer diameter (fixed)</i> <i>15 x cable outer diameter (not fixed)</i>
Riferimenti normativi costruttivi <i>Standards of construction</i>	Flame res.: IEC 60332-1-2, DIN VDE 0472 part. 804 Other: CEI EN 60228, VDE 0295, VDE 0207, 2014/35/EU (Low Voltage Directive), UE 305/2011, EN 50575 (CPR, Class Eca)

* La CPR per questo prodotto è valida in EU, non in UK.

* The CPR for this product is valid in the EU, not in UK.

Marcatura - Marking

TEKIMA 00500 "LiYY" – CE 4x1 mm² 300/500 V – IEC 60332-1-2 – (prod.reference) = (metric) =

Codifiche e dimensioni - Coding and dimensions

Codice <i>Code</i>	Numero di conduttori <i>Number of conductors</i>	Sezione <i>Size [mm²]</i>	Diametro <i>Diameter [mm]</i>	Peso <i>Weight [kg/km]</i>	Tensione <i>Voltage [V]</i>
CV02X014_00500_GR	2	0,14	3,4	15	300/300
CV02X025_00500_GR	2	0,25	3,7	21	300/300
CV02X034_00500_GR	2	0,34	4,0	29	300/300
CV03X014_00500_GR	3	0,14	3,5	17	300/300
CV03X025_00500_GR	3	0,25	3,9	25	300/300
CV03X034_00500_GR	3	0,34	4,3	34	300/300
CV04X014_00500_GR	4	0,14	3,9	21	300/300
CV04X025_00500_GR	4	0,25	4,3	31	300/300
CV04X034_00500_GR	4	0,34	4,7	41	300/300
CV05X014_00500_GR	5	0,14	4,2	25	300/300
CV05X025_00500_GR	5	0,25	4,7	36	300/300
CV05X034_00500_GR	5	0,34	5,2	49	300/300
CV06X014_00500_GR	6	0,14	4,6	31	300/300
CV06X025_00500_GR	6	0,25	5,2	42	300/300
CV06X034_00500_GR	6	0,34	5,7	58	300/300

Cavi multipolari per posa fissa - Cables for fixed applications

Codice <i>Code</i>	Numero di conduttori <i>Number of conductors</i>	Sezione <i>Size [mm²]</i>	Diametro <i>Diameter [mm]</i>	Peso <i>Weight [kg/km]</i>	Tensione <i>Voltage [V]</i>
CV07X014_00500_GR	7	0,14	4,6	32	300/300
CV07X025_00500_GR	7	0,25	5,2	44	300/300
CV07X034_00500_GR	7	0,34	5,7	60	300/300
CV08X014_00500_GR	8	0,14	5,0	35	300/300
CV08X025_00500_GR	8	0,25	5,6	52	300/300
CV08X034_00500_GR	8	0,34	6,9	75	300/300
CV10X014_00500_GR	10	0,14	5,9	47	300/300
CV10X025_00500_GR	10	0,25	6,6	69	300/300
CV10X034_00500_GR	10	0,34	7,9	95	300/300
CV12X014_00500_GR	12	0,14	6,1	51	300/300
CV12X025_00500_GR	12	0,25	6,8	75	300/300
CV12X034_00500_GR	12	0,34	8,2	105	300/300
CV14X014_00500_GR	14	0,14	6,4	56	300/300
CV14X025_00500_GR	14	0,25	7,2	83	300/300
CV14X034_00500_GR	14	0,34	8,6	116	300/300
CV16X014_00500_GR	16	0,14	6,8	62	300/300
CV16X025_00500_GR	16	0,25	7,6	92	300/300
CV16X034_00500_GR	16	0,34	9,0	127	300/300
CV18X014_00500_GR	18	0,14	7,2	71	300/300
CV18X025_00500_GR	18	0,25	8,1	99	300/300
CV18X034_00500_GR	18	0,34	9,5	145	300/300
CV25X014_00500_GR	25	0,14	8,0	95	300/300
CV25X025_00500_GR	25	0,25	9,5	115	300/300
CV25X034_00500_GR	25	0,34	11,3	187	300/300

Composizione del codice - Code composition

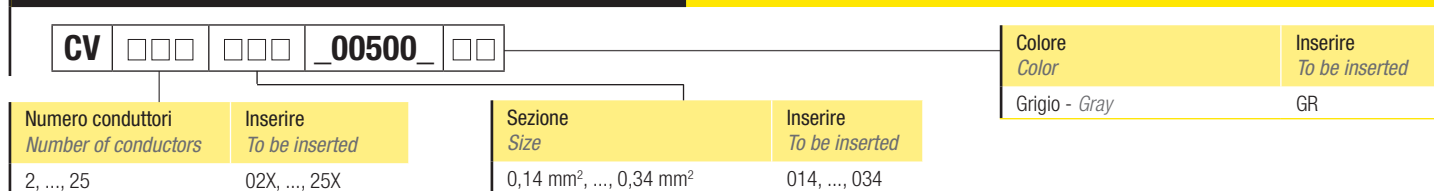

**SERIES
50S**

Cavi "LiYCY" per trasmissione dati "LiYCY" data transmission cables



Posa fissa, schermati - Fixed application, shielded



Impiego - Use

Sono cavi per segnale e controllo costruiti per applicazioni industriali di trasmissione segnali e bus caratterizzati da movimenti scarsamente ripetitivi e che utilizzano lo standard di colorazione DIN 47100.

These are communication and control cables for mobile use with scarcely repetitive movements and designed for general purpose installation in industrial signal and bus applications that utilize the DIN 47100 color code.

Informazione. Si effettua, su richiesta, un servizio aggiuntivo di taglio a misura.
Information. An additional cut-to-length service is carried out on request.

Dati tecnici - Technical data

Caratteristica - Characteristics	Valore/proprietà - Value/property
Conduttore <i>Conductor</i>	Trefolo flessibile in rame, classe 5 <i>Flexible copper strand, class 5</i>
Isolamento <i>Insulation</i>	Mescola di PVC <i>PVC compound</i>
Distinzione conduttori <i>Conductor distinction</i>	In accordo allo standard DIN 47100 <i>According to DIN 47100 Standard</i>
Schermatura <i>Shield</i>	Treccia di rame stagnato, ricopertura nom. 80% <i>Tinned copper braid, nom. coverage 80%</i>
Guaina <i>Jacket</i>	Mescola di PVC, colore grigio RAL 7001. Marcatura metrica <i>PVC compound, RAL 7001 gray color. Metric marking</i>
Temperatura di esercizio <i>Temperature range</i>	-40°C, +80°C (posa fissa); -5°C, +70°C (mobile occasionale) <i>-40°C, +80°C (fixed); -5°C, +70°C (not fixed)</i>
Tensione nominale <i>Voltage rating</i>	300/300 V ($\leq 0,34 \text{ mm}^2$) 300/500 V ($> 0,34 \text{ mm}^2$)
Tensione di prova <i>Test voltage</i>	3000 V
Capacità <i>Capacitance</i>	0,14 mm ² : 120 nF/km; >0,14 mm ² : 150 nF/km (cond./cond.) 0,14 mm ² : 200 nF/km; >0,14 mm ² : 270 nF/km (cond./shield)
Induttanza lineare <i>Linear inductance</i>	approx. 0,65 mH/km
Raggio di curvatura <i>Bending radius</i>	6 volte diametro esterno del cavo (posa fissa) 20 volte diametro esterno del cavo (posa mobile non ciclica) <i>6 x cable outer diameter (fixed)</i> <i>20 x cable outer diameter (not fixed)</i>
Riferimenti normativi costruttivi <i>Standards of construction</i>	Flame res.: IEC 60332-1-2, DIN VDE 0472 part. 804 I Other: CEI EN 60228, VDE 0295, VDE 0207, 2014/35/EU (Low Voltage Directive), UE 305/2011, EN 50575 (CPR, Class Eca)

* La CPR per questo prodotto è valida in EU, non in UK.

* The CPR for this product is valid in the EU, not in UK.

Marcatura - Marking

TEKIMA 0050S "LiYCY" – CE 4x1 mm² 300/500 V – IEC 60332-1-2 – (prod.reference) = (metric) =

Codifiche e dimensioni - Coding and dimensions

Codice <i>Code</i>	Numero di conduttori <i>Number of conductors</i>	Sezione <i>Size [mm²]</i>	Diametro <i>Diameter [mm]</i>	Peso <i>Weight [kg/km]</i>	Tensione <i>Voltage [V]</i>
CV02X014_0050S_GR	2	0,14	3,6	17	300/300
CV02X025_0050S_GR	2	0,25	3,9	21	300/300
CV02X034_0050S_GR	2	0,34	4,4	29	300/300
CV03X014_0050S_GR	3	0,14	3,7	20	300/300
CV03X025_0050S_GR	3	0,25	4,1	27	300/300
CV03X034_0050S_GR	3	0,34	4,9	35	300/300
CV04X014_0050S_GR	4	0,14	4,0	23	300/300
CV04X025_0050S_GR	4	0,25	4,6	33	300/300

Cavi multipolari per posa fissa - Cables for fixed applications

Codice Code	Numero di conduttori Number of conductors	Sezione Size [mm ²]	Diametro Diameter [mm]	Peso Weight [kg/km]	Tensione Voltage [V]
CV04X034_0050S_GR	4	0,34	5,3	43	300/300
CV05X014_0050S_GR	5	0,14	4,5	29	300/300
CV05X025_0050S_GR	5	0,25	4,9	40	300/300
CV05X034_0050S_GR	5	0,34	5,8	54	300/300
CV06X014_0050S_GR	6	0,14	4,8	33	300/300
CV06X025_0050S_GR	6	0,25	5,5	44	300/300
CV06X034_0050S_GR	6	0,34	6,3	60	300/300
CV07X014_0050S_GR	7	0,14	5,2	35	300/300
CV07X025_0050S_GR	7	0,25	5,5	48	300/300
CV07X034_0050S_GR	7	0,34	6,3	65	300/300
CV08X014_0050S_GR	8	0,14	5,4	40	300/300
CV08X025_0050S_GR	8	0,25	6,0	57	300/300
CV08X034_0050S_GR	8	0,34	7,0	75	300/300
CV10X014_0050S_GR	10	0,14	5,7	51	300/300
CV10X025_0050S_GR	10	0,25	6,6	69	300/300
CV10X034_0050S_GR	10	0,34	7,9	94	300/300
CV12X014_0050S_GR	12	0,14	6,0	56	300/300
CV12X025_0050S_GR	12	0,25	7,2	77	300/300
CV12X034_0050S_GR	12	0,34	8,2	105	300/300
CV14X014_0050S_GR	14	0,14	6,6	69	300/300
CV14X025_0050S_GR	14	0,25	7,6	105	300/300
CV14X034_0050S_GR	14	0,34	8,8	144	300/300
CV16X014_0050S_GR	16	0,14	6,8	83	300/300
CV16X025_0050S_GR	16	0,25	8,2	119	300/300
CV16X034_0050S_GR	16	0,34	9,5	157	300/300
CV18X014_0050S_GR	18	0,14	7,3	98	300/300
CV18X025_0050S_GR	18	0,25	8,5	128	300/300
CV18X034_0050S_GR	18	0,34	9,7	173	300/300
CV25X014_0050S_GR	25	0,14	8,6	125	300/300
CV25X025_0050S_GR	25	0,25	10,1	165	300/300
CV25X034_0050S_GR	25	0,34	11,8	206	300/300

Composizione del codice - Code composition

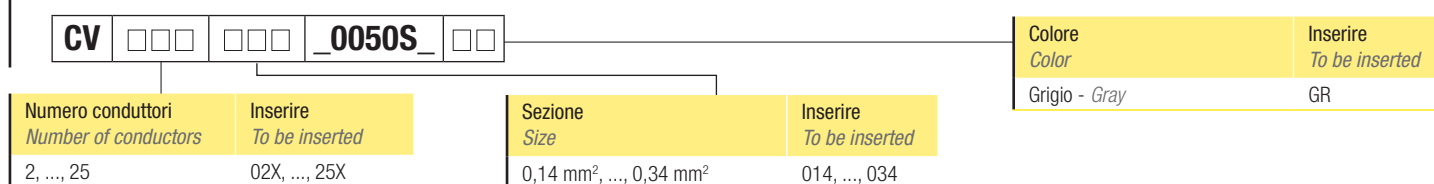

SERIES
100

Cavi multipolari "Flextek" antiolio e UV resistant altamente flessibili



"Flextek" high flexible oil-resistant and UV-resistant cables

Posa fissa, non schermati - Fixed application, unshielded



Impiego - Use

Sono cavi progettati per impiego fisso a bordo macchina o per impieghi mobili occasionali e non ciclici anche in catena portacavi fino a 5 metri e per formazioni da 0,5 mm² fino a 2,5 mm² con un massimo di 6 conduttori privo di sollecitazioni a trazione. Vengono normalmente utilizzati per l'equipaggiamento di apparecchiature destinate al mercato Europeo (CE). La loro buona resistenza all'olio ed all'abrasione ne permette l'utilizzo in collegamenti statici senza particolari protezioni e senza che ne vengano compromesse le qualità elettriche e meccaniche originali. Sono inoltre idonei alla posa in qualsiasi ambiente industriale, sia interno che esterno. La marcatura metrica stampigliata sulla guaina del cavo ne favorisce la lavorazione e l'installazione.

They are cables designed for fixed applications or for occasional and non-cyclic mobile use even in drag-chains up to 5 meters and for sizes from 0.5 mm² to 2.5 mm² with a maximum of 6 conductors without tensile stress. They are normally used for equipments meant for the European market (EC). Their good oil and abrasion resistance permit their use in static connections without particular protections and without compromising the original electrical and mechanical properties. They are also suitable for the installation in any industrial environment, both indoor and outdoor. The metric marked on the jacket allows an easier processing and installation of the cable.

Informazione. Si effettua, su richiesta, un servizio aggiuntivo di taglio a misura.
Information. An additional cut-to-length service is carried out on request.

Marcatura - Marking

TEKIMA 01000 "FLEXTEK" – CE 50G1 mm² 450/750 V – IEC 60332-1-2 – UV RESISTANT – (prod.reference) = (metric) =

Dati tecnici - Technical data

Caratteristica - Characteristics	Valore/proprietà - Value/property
Conduttore <i>Conductor</i>	Trefolo flessibile in rame rosso cl. 5 - CEI EN 60228 <i>Flexible red copper strand</i>
Isolamento <i>Insulation</i>	Mescola di PVC <i>PVC compound</i>
Distinzione conduttori <i>Conductor distinction</i>	Neri numerati + giallo/verde (a partire dai 3 conduttori) <i>Black numbered + yellow/green (beginning from 3 conductors)</i>
Guaina <i>Jacket</i>	Mescola di PVC antiolio, colore grigio RAL 7001 o nero. Marcatura metrica. <i>Oil-resistant PVC compound, RAL 7001 gray color or black. Metric marking.</i>
Temperatura di esercizio <i>Temperature range</i>	-40°C, +80°C (posa fissa); -5°C, +70°C (mobile occasionale) <i>-40°C, +80°C (fixed); -5°C, +70°C (not fixed)</i>
Tensione nominale <i>Voltage rating</i>	450/750 V
Tensione di prova <i>Test voltage</i>	4000 V
Raggio di curvatura <i>Bending radius</i>	4 volte diametro esterno del cavo (posa fissa) 15 volte diametro esterno del cavo (posa mobile non ciclica) <i>4 x external cable diameter (fixed)</i> <i>15 x external cable diameter (not fixed)</i>
Riferimenti normativi <i>Standards</i>	Flame res.: IEC 60332-1-2 Oil res.: CEI 20-34 UV res.: UNI EN ISO 4892-3 (grigio/gray), UNI EN ISO 4892-2 (nero/black) Other: CEI EN 60228, VDE 0295, CEI 20-11, VDE 0207, 2014/35/EU (Low Voltage Directive), UE 305/2011, EN 50575 (CPR, Class Eca)

* La CPR per questo prodotto è valida in EU, non in UK.
* The CPR for this product is valid in the EU, not in UK.

Codifiche e dimensioni - Coding and dimensions

Codice <i>Code</i>	Numero di conduttori <i>Number of conductors</i>	Sezione <i>Size [mm²]</i>	Diametro <i>Diameter [mm]</i>	Peso <i>Weight [kg/km]</i>	Tensione <i>Voltage [V]</i>
CV02X050_01000_GR	2	0,5	4,4	30	450/750
CV02X075_01000_GR	2	0,75	4,8	37	450/750
CV02X100_01000_GR	2	1,0	5,1	44	450/750
CV02X150_01000_GR	2	1,5	5,7	59	450/750
CV02X250_01000_GR	2	2,5	7,1	94	450/750
CV02X400_01000_GR	2	4,0	8,6	143	450/750
CV02X600_01000_GR	2	6,0	10	201	450/750
CV03G050_01000_GR	3	0,5	4,7	36	450/750
CV03G075_01000_GR	3	0,75	5,1	46	450/750
CV03G100_01000_GR	3	1,0	5,5	56	450/750
CV03G150_01000_GR	3	1,5	6,3	78	450/750
CV03G250_01000_GR	3	2,5	7,6	120	450/750
CV03G400_01000_GR	3	4,0	9,1	181	450/750
CV03G600_01000_GR	3	6,0	10,9	265	450/750
CV03GB10_01000_GR	3	10	13,7	430	450/750
CV03GB16_01000_GR	3	16	16	637	450/750
CV03GB50_01000_GR	3	50	27,6	1939	450/750
CV04G050_01000_GR	4	0,5	5,1	44	450/750
CV04G075_01000_GR	4	0,75	5,6	57	450/750

Cavi multipolari per posa fissa - Cables for fixed applications

Codice Code	Numero di conduttori Number of conductors	Sezione Size [mm ²]	Diametro Diameter [mm]	Peso Weight [kg/km]	Tensione Voltage [V]
CV04G100_01000_GR	4	1,0	6,2	73	450/750
CV04G150_01000_GR	4	1,5	6,9	98	450/750
CV04G250_01000_GR	4	2,5	8,5	155	450/750
CV04G400_01000_GR	4	4,0	10,1	232	450/750
CV04G600_01000_GR	4	6,0	12	337	450/750
CV04GB10_01000_GR	4	10	15,3	554	450/750
CV04GB16_01000_GR	4	16	17,8	821	450/750
CV04GB25_01000_GR	4	25	22,3	1284	450/750
CV04GB35_01000_GR	4	35	25,3	1728	450/750
CV04GB50_01000_GR	4	50	30,9	2514	450/750
CV04GB70_01000_GR	4	70	34,4	3317	450/750
CV04GB95_01000_GR	4	95	41,2	4630	450/750
CV05G050_01000_GR	5	0,5	5,7	55	450/750
CV05G075_01000_GR	5	0,75	6,4	74	450/750
CV05G100_01000_GR	5	1,0	6,8	89	450/750
CV05G150_01000_GR	5	1,5	7,6	120	450/750
CV05G250_01000_GR	5	2,5	9,4	192	450/750
CV05G400_01000_GR	5	4,0	11,3	290	450/750
CV05G600_01000_GR	5	6,0	13,5	424	450/750
CV05GB10_01000_GR	5	10	17,2	696	450/750
CV05GB16_01000_GR	5	16	20	1031	450/750
CV05GB25_01000_GR	5	25	25	1608	450/750
CV05GB35_01000_GR	5	35	28,6	2181	450/750
CV05GB50_01000_GR	5	50	34,6	3147	450/750
CV05GB95_01000_GR	5	95	46,5	5835	450/750
CV06G050_01000_GR	6	0,5	6,4	69	450/750
CV06G075_01000_GR	6	0,75	7	89	450/750
CV06G100_01000_GR	6	1,0	7,4	106	450/750
CV06G150_01000_GR	6	1,5	8,5	148	450/750
CV07G050_01000_GR	7	0,5	6,4	72	450/750
CV07G075_01000_GR	7	0,75	7	94	450/750
CV07G100_01000_GR	7	1,0	7,4	112	450/750
CV07G150_01000_GR	7	1,5	8,5	158	450/750
CV07G250_01000_GR	7	2,5	10,3	247	450/750
CV07G400_01000_GR	7	4,0	12,4	376	450/750
CV07G600_01000_GR	7	6,0	15,1	561	450/750
CV07GB10_01000_GR	7	10	18,8	903	450/750
CV07GB16_01000_GR	7	16	22,2	1364	450/750
CV07GB25_01000_GR	7	25	27,7	2125	450/750
CV08G050_01000_GR	8	0,5	7,5	94	450/750
CV08G075_01000_GR	8	0,75	8,2	120	450/750
CV08G100_01000_GR	8	1,0	8,9	148	450/750
CV08G150_01000_GR	8	1,5	10	201	450/750
CV08G250_01000_GR	8	2,5	12,3	318	450/750
CV09G050_01000_GR	9	0,5	7,9	104	450/750
CV09G075_01000_GR	9	0,75	8,8	137	450/750
CV09G100_01000_GR	9	1,0	9,4	166	450/750
CV09G150_01000_GR	9	1,5	10,7	229	450/750
CV10G050_01000_GR	10	0,5	8	110	450/750
CV10G075_01000_GR	10	0,75	9	147	450/750
CV10G100_01000_GR	10	1,0	9,6	177	450/750
CV10G150_01000_GR	10	1,5	11	247	450/750
CV10G250_01000_GR	10	2,5	13,5	390	450/750
CV12G050_01000_GR	12	0,5	8,5	126	450/750
CV12G075_01000_GR	12	0,75	9,3	163	450/750
CV12G100_01000_GR	12	1,0	9,9	198	450/750
CV12G150_01000_GR	12	1,5	11,3	276	450/750
CV12G250_01000_GR	12	2,5	14	441	450/750
CV14G050_01000_GR	14	0,5	8,9	141	450/750
CV14G075_01000_GR	14	0,75	9,8	185	450/750

Code Codice	Numero di conduttori Number of conductors	Sezione Size [mm ²]	Diametro Diameter [mm]	Peso Weight [kg/km]	Tensione Voltage [V]
CV14G100_01000_GR	14	1,0	10,4	223	450/750
CV14G150_01000_GR	14	1,5	11,9	313	450/750
CV14G250_01000_GR	14	2,5	14,7	499	450/750
CV16G050_01000_GR	16	0,5	9,4	159	450/750
CV16G075_01000_GR	16	0,75	10,3	207	450/750
CV16G100_01000_GR	16	1,0	11,2	257	450/750
CV16G150_01000_GR	16	1,5	12,6	354	450/750
CV16G250_01000_GR	16	2,5	15,7	570	450/750
CV18G050_01000_GR	18	0,5	10	179	450/750
CV18G075_01000_GR	18	0,75	11,2	240	450/750
CV18G100_01000_GR	18	1,0	11,9	290	450/750
CV18G150_01000_GR	18	1,5	13,6	406	450/750
CV18G250_01000_GR	18	2,5	16,7	643	450/750
CV19G050_01000_GR	19	0,5	10	183	450/750
CV19G075_01000_GR	19	0,75	11,2	245	450/750
CV19G100_01000_GR	19	1,0	11,9	297	450/750
CV19G150_01000_GR	19	1,5	13,6	417	450/750
CV21G100_01000_GR	21	1,0	13,3	352	450/750
CV24G050_01000_GR	24	0,5	11,7	243	450/750
CV24G075_01000_GR	24	0,75	13	322	450/750
CV24G100_01000_GR	24	1,0	13,9	392	450/750
CV24G150_01000_GR	24	1,5	15,8	545	450/750
CV25G050_01000_GR	25	0,5	11,7	247	450/750
CV25G075_01000_GR	25	0,75	13,1	330	450/750
CV25G100_01000_GR	25	1,0	13,9	399	450/750
CV25G150_01000_GR	25	1,5	15,8	556	450/750
CV25G250_01000_GR	25	2,5	19,7	894	450/750
CV34G050_01000_GR	34	0,5	13,9	344	450/750
CV34G075_01000_GR	34	0,75	15,5	457	450/750
CV34G100_01000_GR	34	1,0	16,5	553	450/750
CV34G150_01000_GR	34	1,5	18,8	772	450/750
CV34G250_01000_GR	34	2,5	23,3	1234	450/750
CV36G100_01000_GR	36	1,0	16,5	567	450/750
CV37G050_01000_GR	37	0,5	13,9	354	450/750
CV37G075_01000_GR	37	0,75	15,5	473	450/750
CV37G100_01000_GR	37	1,0	16,5	574	450/750
CV37G150_01000_GR	37	1,5	18,8	803	450/750
CV41G050_01000_GR	41	0,5	15,1	409	450/750
CV41G075_01000_GR	41	0,75	16,6	535	450/750
CV41G100_01000_GR	41	1,0	18	662	450/750
CV41G150_01000_GR	41	1,5	20,4	919	450/750
CV42G050_01000_GR	42	0,5	15,1	412	450/750
CV42G075_01000_GR	42	0,75	16,6	540	450/750
CV42G100_01000_GR	42	1,0	18	669	450/750
CV42G150_01000_GR	42	1,5	20,4	930	450/750
CV43G050_01000_GR	43	0,5	15,3	423	450/750
CV50G050_01000_GR	50	0,5	16,4	488	450/750
CV50G075_01000_GR	50	0,75	18,2	647	450/750
CV50G100_01000_GR	50	1,0	19,7	799	450/750
CV50G150_01000_GR	50	1,5	22,4	1114	450/750
CV56G050_01000_GR	56	0,5	17,4	548	450/750
CV56G075_01000_GR	56	0,75	19,4	731	450/750
CV56G100_01000_GR	56	1,0	20,7	888	450/750
CV56G150_01000_GR	56	1,5	23,5	1236	450/750
CV61G050_01000_GR	61	0,5	17,7	578	450/750
CV61G075_01000_GR	61	0,75	19,7	770	450/750
CV61G100_01000_GR	61	1,0	21	937	450/750
CV61G150_01000_GR	61	1,5	24	1317	450/750
CV65G100_01000_GR	65	1,0	22,5	1041	450/750

Composizione del codice - Code composition

Numero conduttori <i>Number of conductors</i>		Inserire <i>To be inserted</i>	Sezione <i>Size</i>		Colore <i>Color</i>						
2	3, ..., 65	02X	03G, ..., 65G	0,14 mm ² , ..., 6,00 mm ²	10,0 mm ² , ..., 95,0 mm ²	014, ..., 600	B10, ..., B95	Grigio - <i>Gray</i>	Nero - <i>Black</i>	GR	NE

**SERIES
100S**

Cavi multipolari "Flextek" antiolio e UV resistant altamente flessibili



"Flextek" high flexible oil-resistant and UV-resistant cables

Posa fissa, schermati - Fixed application, shielded



Impiego - Use

Sono cavi progettati per impiego fisso a bordo macchina o per impieghi mobili occasionali e non ciclici. Vengono normalmente utilizzati per l'equipaggiamento di apparecchiature destinate al mercato Europeo (CE). La loro buona resistenza all'olio ed all'abrasione ne permette l'utilizzo in collegamenti statici senza particolari protezioni e senza che ne vengano compromesse le qualità elettriche e meccaniche originali. Sono inoltre idonei alla posa in qualsiasi ambiente industriale, sia interno che esterno. La marcatura metrica stampigliata sulla guaina del cavo ne favorisce la lavorazione e l'installazione.

These are machine tool wire cables planned also for occasional non-cyclical mobile uses. They are normally used for equipments meant for the European market (EC). Their good oil and abrasion resistance permit their use in static connections without particular protections and without compromising the original electrical and mechanical properties. They are also suitable for the installation in any industrial environment, both indoor and outdoor. The metric marked on the jacket allows an easier processing and installation of the cable.

Informazione. Si effettua, su richiesta, un servizio aggiuntivo di taglio a misura.
Information. An additional cut-to-length service is carried out on request.

Dati tecnici - Technical data

Caratteristica - Characteristics	Valore/proprietà - Value/property
Conduttore <i>Conductor</i>	Trefolo flessibile in rame rosso cl. 5 - CEI EN 60228 <i>Flexible red copper strand</i>
Isolamento <i>Insulation</i>	Mescola di PVC <i>PVC compound</i>
Distinzione conduttori <i>Conductor distinction</i>	Neri numerati + giallo/verde (a partire dai 3 conduttori) <i>Black numbered + yellow/green (beginning from 3 conductors)</i>
Schermatura <i>Shield</i>	Treccia di rame stagnato, ricopertura nom. 75% <i>Tinned copper braid, nom. coverage 75%</i>
Guaina <i>Jacket</i>	Mescola di PVC antiolio, colore grigio RAL 7001 o nero. Marcatura metrica. <i>Oil-resistant PVC compound, RAL 7001 gray color or black. Metric marking.</i>
Temperatura di esercizio <i>Temperature range</i>	-40°C, +80°C (posa fissa); -5°C, +70°C (mobile occasionale) <i>-40°C, +80°C (fixed); -5°C, +70°C (not fixed)</i>
Tensione nominale <i>Voltage rating</i>	450/750 V
Tensione di prova <i>Test voltage</i>	4000 V
Raggio di curvatura <i>Bending radius</i>	6 volte diametro esterno del cavo (posa fissa) 20 volte diametro esterno del cavo (posa mobile non ciclica) <i>6 x cable outer diameter (fixed) 20 x cable outer diameter (not fixed)</i>
Riferimenti normativi <i>Standards of use</i>	Flame res.: IEC 60332-1-2 Oil res.: CEI 20-34 UV res.: UNI EN ISO 4892-3 (grigio/gray), UNI EN ISO 4892-2 (nero/black) Other: CEI EN 60228, VDE 0295, CEI 20-11, VDE 0207, 2014/35/EU (Low Voltage Directive), UE 305/2011, EN 50575 (CPR, Class Eca)

* La CPR per questo prodotto è valida in EU, non in UK.
* The CPR for this product is valid in the EU, not in UK.

Marcatura - Marking

TEKIMA 0100S "FLEXTEK" - CE 50G1 mm² 450/750 V - IEC 60332-1-2 - UV RESISTANT - (prod.reference) = (metric) =

Codifiche e dimensioni - Coding and dimensions

Codice <i>Code</i>	Numero di conduttori <i>Number of conductors</i>	Sezione <i>Size [mm²]</i>	Diametro <i>Diameter [mm]</i>	Peso <i>Weight [kg/km]</i>	Tensione <i>Voltage [V]</i>
CV02X050_0100S_GR	2	0,5	5,4	45	450/750
CV02X075_0100S_GR	2	0,75	6,0	55	450/750
CV02X100_0100S_GR	2	1,0	6,3	61	450/750
CV02X150_0100S_GR	2	1,5	6,9	74	450/750
CV02X250_0100S_GR	2	2,5	8,3	108	450/750
CV02X400_0100S_GR	2	4,0	9,8	157	450/750
CV02X600_0100S_GR	2	6,0	11,4	217	450/750
CV03G050_0100S_GR	3	0,5	5,7	52	450/750
CV03G075_0100S_GR	3	0,75	6,3	64	450/750
CV03G100_0100S_GR	3	1,0	6,7	73	450/750
CV03G150_0100S_GR	3	1,5	7,5	94	450/750
CV03G250_0100S_GR	3	2,5	9,0	142	450/750

Cavi multipolari per posa fissa - Cables for fixed applications

Codice Code	Numero di conduttori Number of conductors	Sezione Size [mm ²]	Diametro Diameter [mm]	Peso Weight [kg/km]	Tensione Voltage [V]
CV03G400_0100S_GR	3	4,0	10,5	202	450/750
CV03G600_0100S_GR	3	6,0	12,3	286	450/750
CV03GB10_0100S_GR	3	10	15,3	450	450/750
CV03GB16_0100S_GR	3	16	18,0	674	450/750
CV04G050_0100S_GR	4	0,5	6,3	64	450/750
CV04G075_0100S_GR	4	0,75	6,8	76	450/750
CV04G100_0100S_GR	4	1,0	7,2	87	450/750
CV04G150_0100S_GR	4	1,5	8,1	121	450/750
CV04G250_0100S_GR	4	2,5	9,7	182	450/750
CV04G400_0100S_GR	4	4,0	11,5	263	450/750
CV04G600_0100S_GR	4	6,0	13,6	377	450/750
CV04GB10_0100S_GR	4	10	17,1	610	450/750
CV04GB16_0100S_GR	4	16	19,8	888	450/750
CV04GB25_0100S_GR	4	25	24,5	1362	450/750
CV04GB35_0100S_GR	4	35	33,7	2117	450/750
CV04GB50_0100S_GR	4	50	37,4	2757	450/750
CV05G050_0100S_GR	5	0,5	6,9	74	450/750
CV05G075_0100S_GR	5	0,75	7,6	96	450/750
CV05G100_0100S_GR	5	1,0	8,0	110	450/750
CV05G150_0100S_GR	5	1,5	9,0	147	450/750
CV05G250_0100S_GR	5	2,5	10,8	221	450/750
CV05G400_0100S_GR	5	4,0	12,7	321	450/750
CV05G600_0100S_GR	5	6,0	15,1	459	450/750
CV05GB10_0100S_GR	5	10	19,2	752	450/750
CV05GB16_0100S_GR	5	16	22,2	1092	450/750
CV05GB25_0100S_GR	5	25	27,9	1702	450/750
CV07G050_0100S_GR	7	0,5	7,6	95	450/750
CV07G075_0100S_GR	7	0,75	8,2	115	450/750
CV07G100_0100S_GR	7	1,0	8,6	137	450/750
CV07G150_0100S_GR	7	1,5	9,7	184	450/750
CV07G250_0100S_GR	7	2,5	11,9	283	450/750
CV07G400_0100S_GR	7	4,0	14,0	417	450/750
CV07G600_0100S_GR	7	6,0	16,7	598	450/750
CV07GB10_0100S_GR	7	10	21,0	976	450/750
CV07GB16_0100S_GR	7	16	24,4	1434	450/750
CV10G050_0100S_GR	10	0,5	9,4	130	450/750
CV12G050_0100S_GR	12	0,5	9,7	148	450/750
CV12G075_0100S_GR	12	0,75	10,7	188	450/750
CV12G100_0100S_GR	12	1,0	11,3	223	450/750
CV12G150_0100S_GR	12	1,5	12,7	302	450/750
CV12G250_0100S_GR	12	2,5	15,6	469	450/750
CV14G050_0100S_GR	14	0,5	10,1	165	450/750
CV14G075_0100S_GR	14	0,75	11,2	213	450/750
CV14G100_0100S_GR	14	1,0	12,0	256	450/750
CV14G150_0100S_GR	14	1,5	13,5	347	450/750
CV14G250_0100S_GR	14	2,5	16,5	539	450/750
CV16G050_0100S_GR	16	0,5	10,8	190	450/750
CV16G075_0100S_GR	16	0,75	11,9	242	450/750
CV16G100_0100S_GR	16	1,0	12,6	289	450/750
CV16G150_0100S_GR	16	1,5	14,2	392	450/750
CV16G250_0100S_GR	16	2,5	17,7	629	450/750
CV18G050_0100S_GR	18	0,5	11,4	209	450/750
CV18G075_0100S_GR	18	0,75	12,6	272	450/750
CV18G100_0100S_GR	18	1,0	13,5	327	450/750
CV18G150_0100S_GR	18	1,5	15,2	442	450/750
CV18G250_0100S_GR	18	2,5	18,7	705	450/750
CV25G050_0100S_GR	25	0,5	13,3	279	450/750
CV25G075_0100S_GR	25	0,75	14,7	362	450/750
CV25G100_0100S_GR	25	1,0	15,5	432	450/750

Codice Code	Numero di conduttori Number of conductors	Sezione Size [mm ²]	Diametro Diameter [mm]	Peso Weight [kg/km]	Tensione Voltage [V]
CV25G150_0100S_GR	25	1,5	17,8	606	450/750
CV25G250_0100S_GR	25	2,5	21,7	939	450/750
CV34G050_0100S_GR	34	0,5	15,5	374	450/750
CV34G075_0100S_GR	34	0,75	17,3	496	450/750
CV34G100_0100S_GR	34	1,0	18,5	602	450/750
CV34G150_0100S_GR	34	1,5	21,0	824	450/750
CV34G250_0100S_GR	34	2,5	25,7	1279	450/750
CV37G075_0100S_GR	37	0,75	17,3	520	450/750
CV37G100_0100S_GR	37	1,0	18,5	633	450/750
CV37G150_0100S_GR	37	1,5	21,0	869	450/750
CV41G075_0100S_GR	41	0,75	18,6	596	450/750
CV41G100_0100S_GR	41	1,0	20,0	716	450/750
CV41G150_0100S_GR	41	1,5	22,6	987	450/750
CV42G075_0100S_GR	42	0,75	18,6	606	450/750
CV42G100_0100S_GR	42	1,0	20,0	728	450/750
CV42G150_0100S_GR	42	1,5	22,6	1005	450/750
CV50G075_0100S_GR	50	0,75	20,2	697	450/750
CV50G100_0100S_GR	50	1,0	21,7	839	450/750
CV50G150_0100S_GR	50	1,5	24,6	1157	450/750
CV61G075_0100S_GR	61	0,75	21,7	823	450/750
CV61G100_0100S_GR	61	1,0	23,2	1000	450/750
CV61G150_0100S_GR	61	1,5	26,4	1393	450/750

Composizione del codice - Code composition

CV □□□ □□□ _0100S_ □□				Colore Color	Inserire To be inserted
Numero conduttori Number of conductors	Inserire To be inserted	Sezione Size	Inserire To be inserted	Grigio - Gray	GR
2	02X	0,14 mm ² , ..., 6,00 mm ²	014, ..., 600	Nero - Black	NE
3, ..., 61	03G, ..., 61G	10,0 mm ² , ..., 95,0 mm ²	B10, ..., B95		

**SERIES
100**

Cavi multipolari “Flextek Hybrid Black”, UV resistant



“Flextek Hybrid Black” high flexible, UV-resistant cables

Posa fissa, schermati e non schermati - Fixed application, shielded and unshielded



Impiego - Use

Sono cavi resistenti ai raggi UV e progettati per impiego fisso a bordo macchina o per impieghi mobili occasionali e non ciclici. Vengono normalmente utilizzati per l'equipaggiamento di apparecchiature destinate al mercato Europeo (CE). La loro buona resistenza all'olio ed all'abrasione ne permette l'utilizzo in collegamenti statici senza particolari protezioni e senza che ne vengano compromesse le qualità elettriche e meccaniche originali. L'ottima resistenza alla fiamma e ai raggi UV li rende inoltre idonei alla posa in qualsiasi ambiente industriale, sia interno che esterno. La marcatura metrica stampigliata sulla guaina del cavo ne favorisce la lavorazione e l'installazione.

These are machine tool wire UV-resistant cables planned also for occasional non-cyclical mobile uses. They are normally used for equipments meant for the European market (EC). Their good oil and abrasion resistance permit their use in static connections without particular protections and without compromising the original electrical and mechanical properties. The good flame and UV resistance makes them suitable for the installation in any industrial environment, both indoor and outdoor. The metric marked on the jacket allows an easier processing and installation of the cable.

Informazione. Si effettua, su richiesta, un servizio aggiuntivo di taglio a misura.
Information. An additional cut-to-length service is carried out on request.

Dati Tecnici - Technical data

Caratteristica - Characteristics	Valore/proprietà - Value/property
Conduttore <i>Conductor</i>	Trefolo flessibile in rame rosso cl. 5 - CEI 20-29 <i>Flexible red copper strand</i>
Isolamento <i>Insulation</i>	TKblend®-R
Distinzione conduttori <i>Conductor distinction</i>	Marrone, Nero, Grigio, Giallo/Verde (potenza/power) Rosso, Rosso/Bianco (segnale/signal)
Schematura <i>Shield</i>	Treccia di rame stagnato, ricopertura >85% <i>Tinned copper braid, coverage >85%</i>
Guaina <i>Jacket</i>	Miscela di PVC antiolio, antifiamma e UV resistant, colore nero. Marcatura metrica. <i>Oil, flame-resistant and UV-resistant PVC compound, black color. Metric marking.</i>
Temperatura di esercizio <i>Temperature range</i>	-40°C, +80°C (posa fissa); -5°C, +70°C (mobile occasionale) <i>-40°C, +80°C (fixed); -5°C, +70°C (not fixed)</i>
Tensione nominale <i>Voltage rating</i>	450/750 V
Tensione di prova <i>Test voltage</i>	4000 V
Raggio di curvatura <i>Bending radius</i>	6 volte diametro esterno del cavo (posa fissa) 20 volte diametro esterno del cavo (posa mobile non ciclica) <i>6 x cable outer diameter (fixed) 20 x cable outer diameter (not fixed)</i>
Riferimenti normativi <i>Standards</i>	Flame res.: IEC 60332-1-2 Oil res.: CEI 20-34 UV res.: UNI EN ISO 4892-2 (nero/black) Other: CEI EN 60228, VDE 0295, CEI 20-11, VDE 0207, 2014/35/EU (Low Voltage Directive), UE 305/2011, EN 50575 (CPR, Class Eca)

* La CPR per questo prodotto è valida in EU, non in UK.
* The CPR for this product is valid in the EU, not in UK.

Marcatura - Marking

TEKIMA 01000 “FLEXTEK BLACK” – CE 4G1,5+2x1 mm² 450/750 V – IEC 60332-1-2 – UV RESISTANT – (prod.reference) = (metric) =

Codifiche e dimensioni - Coding and dimensions

Codice <i>Code</i>	N. conduttori x sezione <i>Num. conductors x size</i> [mm ²]	Diametro <i>Diameter</i> [mm]	Peso <i>Weight</i> [kg/km]	Tensione <i>Voltage</i> [V]
CVCC00011_01000_NE	4G1,5+2x0,5	8,5	134	450/750
CVCC00003_01000_NE	4G1,5+2x1	9,1	183	450/750
CVCC00017_0100S_NE	(4G1,5+2x(2x1))	12,6	271	450/750
CVCC00012_01000_NE	4G2,5+2x0,5	10,6	209	450/750
CVCC00006_01000_NE	4G2,5+2x1	10,6	216	450/750
CVCC00018_0100S_NE	(4G2,5+2x(2x1))	14,3	350	450/750

Codice Code	N. conduttori x sezione Num. conductors x size [mm ²]	Diametro Diameter [mm]	Peso Weight [kg/km]	Tensione Voltage [V]
CVCC00008_01000_NE	4G4+2x1	12,0	295	450/750
CVCC00019_0100S_NE	(4G4+2x(2x1))	15,7	441	450/750
CVCC00009_01000_NE	4G6+2x1	14,3	422	450/750
CVCC00020_0100S_NE	(4G6+2x(2x1))	17,3	445	450/750
CVCC00010_01000_NE	4G10+2x1	17,7	661	450/750
CVCC00014_0100S_NE	4G1,5+(4x0,75)	10,6	185	450/750
CVCC00013_0100S_NE	4G2,5+(4x0,75)	11,9	236	450/750

Composizione del codice - Code composition

CVCC	□ □ □ □ □ □	_ 0100	□	_	□ □	Colore Color	Inserire To be inserted
Formazione Construction	Codice identificativo della particolare formazione del cavo. Identifier code of the special cable construction.	Schermatura Shield	Inserire To be inserted	Nero - Black	NE		
		No	0				
		Si/Yes	S				

SERIES
105

Cavi multipolari "Flextek-B" antiolio e UV resistant



"Flextek-B" oil-resistant and UV-resistant cables

Posa fissa, non schermati - Fixed application, unshielded



Impiego - Use

Sono cavi progettati per impiego fisso a bordo macchina o per impieghi mobili occasionali e non ciclici anche in catena portacavi fino a 5 metri e per formazioni da 0.5 mm² fino a 2.5 mm² con un massimo di 6 conduttori privo di sollecitazioni a trazione. Vengono normalmente utilizzati per l'equipaggiamento di apparecchiature destinate al mercato Europeo (CE). La loro buona resistenza all'olio ed all'abrasione ne permette l'utilizzo in collegamenti statici senza particolari protezioni e senza che ne vengano compromesse le qualità elettriche e meccaniche originali. Sono idonei alla posa in ambienti industriali interni ed esterni anche in presenza di umidità. La marcatura metrica stampigliata sulla guaina del cavo ne favorisce la lavorazione e l'installazione.

They are cables designed for fixed applications or for occasional and non-cyclic mobile use even in drag-chains up to 5 meters and for sizes from 0.5 mm² to 2.5 mm² with a maximum of 6 conductors without tensile stress. They are normally used for equipments meant for the European market (EC). Their good oil and abrasion resistance permit their use in static connections without particular protections and without compromising the original electrical and mechanical properties. They are suitable for the installation in dry and damp industrial environments, both indoor and outdoor. The metric marked on the jacket allows an easier processing and installation of the cable.

Informazione. Si effettua, su richiesta, un servizio aggiuntivo di taglio a misura.
Information. An additional cut-to-length service is carried out on request.

Marcatura - Marking

TEKIMA 01050 "FLEXTEK-B" – CE 12G2,5 mm² 600/1000 V – IEC 60332-1-2 – UV RESISTANT – (prod.reference) = (metric) =

Dati tecnici - Technical data

Caratteristica - Characteristics	Valore/proprietà - Value/property
Conduttore Conductor	Trefolo in rame, classe 5 - CEI EN 60228 Copper strand, class 5 - CEI EN 60228
Isolamento Insulation	Mescola di PVC PVC compound
Distinzione conduttori Conductor distinction	Neri numerati + giallo/verde (a partire dai 3 conduttori) Black numbered + yellow/green (beginning from 3 conductors)
Guaina Jacket	Mescola di PVC antiolio e antifiama, colore grigio RAL 7001 o nero. Marcatura metrica. Oil and flame-resistant PVC compound, RAL 7001 gray color or black. Metric marking.
Temperatura di esercizio Temperature range	-40°C, +80°C (posa fissa); -5°C, +70°C (mobile) -40°C, +80°C (fixed); -5°C, +70°C (not fixed)
Tensione nominale Voltage rating	600/1000 V
Tensione di prova Test voltage	6000 V
Raggio di curvatura Bending radius	4 volte diametro esterno del cavo (posa fissa) 15 volte diametro esterno del cavo (posa mobile non ciclica) 4 x cable outer diameter (fixed) 15 x cable outer diameter (not fixed)
Riferimenti normativi costruttivi Standards of construction	Flame res.: IEC 60332-1-2, DIN VDE 0472 part 804 I UV res.: UNI EN ISO 4892-3 (grigio/gray), UNI EN ISO 4892-2 (nero/black) I Other: CEI EN 60228, VDE 0295, CEI 20-11, VDE 0207, 2014/35/EU (Low Voltage Directive), UE 305/2011, EN 50575 (CPR, Class Eca)

* La CPR per questo prodotto è valida in EU, non in UK.
* The CPR for this product is valid in the EU, not in UK.

Codifiche e dimensioni - Coding and dimensions

Codice Code	Numero di conduttori Number of conductors	Sezione Size [mm ²]	Diametro Diameter [mm]	Peso Weight [kg/km]	Tensione Voltage [V]
CV02X050_01050_□□	2	0,5	6,6	58	600/1000
CV02X075_01050_□□	2	0,75	7,0	68	600/1000
CV02X100_01050_□□	2	1,0	7,3	76	600/1000
CV02X150_01050_□□	2	1,5	8,3	101	600/1000
CV02X250_01050_□□	2	2,5	9,5	140	600/1000
CV03G050_01050_□□	3	0,5	7,0	67	600/1000
CV03G075_01050_□□	3	0,75	7,4	80	600/1000
CV03G100_01050_□□	3	1,0	7,7	90	600/1000
CV03G150_01050_□□	3	1,5	8,8	121	600/1000
CV03G250_01050_□□	3	2,5	10,2	175	600/1000
CV03G400_01050_□□	3	4,0	11,6	241	600/1000
CV03G600_01050_□□	3	6,0	13,0	322	600/1000
CV03GB10_01050_□□	3	10	16,1	512	600/1000
CV03GB16_01050_□□	3	16	18,3	722	600/1000
CV04G050_01050_□□	4	0,5	7,5	80	600/1000
CV04G075_01050_□□	4	0,75	8,0	95	600/1000
CV04G100_01050_□□	4	1,0	8,3	109	600/1000
CV04G150_01050_□□	4	1,5	9,5	147	600/1000
CV04G250_01050_□□	4	2,5	11,1	214	600/1000

Codice Code	Numero di conduttori Number of conductors	Sezione Size [mm ²]	Diametro Diameter [mm]	Peso Weight [kg/km]	Tensione Voltage [V]
CV04G400_01050_□□	4	4,0	12,9	305	600/1000
CV04G600_01050_□□	4	6,0	14,2	401	600/1000
CV04GB10_01050_□□	4	10	17,7	642	600/1000
CV04GB16_01050_□□	4	16	20,3	922	600/1000
CV04GB25_01050_□□	4	25	25,2	1431	600/1000
CV04GB35_01050_□□	4	35	28,2	1896	600/1000
CV04GB50_01050_□□	4	50	33,4	2683	600/1000
CV04GB70_01050_□□	4	70	38,8	3688	600/1000
CV04GB95_01050_□□	4	95	43,7	4849	600/1000
CV05G050_01050_□□	5	0,5	8,1	95	600/1000
CV05G075_01050_□□	5	0,75	8,7	114	600/1000
CV05G100_01050_□□	5	1,0	9,1	131	600/1000
CV05G150_01050_□□	5	1,5	10,6	184	600/1000
CV05G250_01050_□□	5	2,5	12,2	261	600/1000
CV05G400_01050_□□	5	4,0	14,1	372	600/1000
CV05G600_01050_□□	5	6,0	15,6	493	600/1000
CV05GB10_01050_□□	5	10	19,8	802	600/1000
CV05GB16_01050_□□	5	16	22,6	1151	600/1000
CV05GB25_01050_□□	5	25	28,1	1786	600/1000
CV05GB35_01050_□□	5	35	31,5	2367	600/1000
CV07G050_01050_□□	7	0,5	8,8	115	600/1000
CV07G075_01050_□□	7	0,75	9,4	140	600/1000
CV07G100_01050_□□	7	1,0	10,0	166	600/1000
CV07G150_01050_□□	7	1,5	11,5	228	600/1000
CV07G250_01050_□□	7	2,5	13,5	334	600/1000
CV07G400_01050_□□	7	4,0	15,4	472	600/1000
CV07G600_01050_□□	7	6,0	17,3	638	600/1000
CV12G050_01050_□□	12	0,5	11,3	192	600/1000
CV12G075_01050_□□	12	0,75	12,1	235	600/1000
CV12G100_01050_□□	12	1,0	13,0	280	600/1000
CV12G150_01050_□□	12	1,5	15,0	387	600/1000
CV12G250_01050_□□	12	2,5	17,6	571	600/1000
CV18G050_01050_□□	18	0,5	13,4	272	600/1000
CV18G075_01050_□□	18	0,75	14,3	334	600/1000
CV18G100_01050_□□	18	1,0	15,1	391	600/1000
CV18G150_01050_□□	18	1,5	17,7	555	600/1000
CV18G250_01050_□□	18	2,5	20,9	821	600/1000
CV25G050_01050_□□	25	0,5	15,2	358	600/1000
CV25G075_01050_□□	25	0,75	16,6	451	600/1000
CV25G100_01050_□□	25	1,0	17,4	529	600/1000
CV25G150_01050_□□	25	1,5	20,5	751	600/1000
CV25G250_01050_□□	25	2,5	24,2	1116	600/1000
CV34G050_01050_□□	34	0,5	17,8	491	600/1000
CV34G075_01050_□□	34	0,75	19,4	618	600/1000
CV34G100_01050_□□	34	1,0	20,5	725	600/1000
CV34G150_01050_□□	34	1,5	24,1	1032	600/1000
CV42G100_01050_□□	42	1,0	22,2	865	600/1000
CV42G150_01050_□□	42	1,5	26,1	1232	600/1000
CV50G100_01050_□□	50	1,0	24,0	1019	600/1000
CV50G150_01050_□□	50	1,5	28,5	1468	600/1000
CV61G100_01050_□□	61	1,0	25,7	1197	600/1000
CV61G150_01050_□□	61	1,5	30,4	1709	600/1000

Composizione del codice - Code composition

CV □□□ □□□ _01050_ □□		<table border="1"> <tr><th>Sezione Size</th><th>Inserire To be inserted</th></tr> <tr><td>0,14 mm², ..., 6,00 mm²</td><td>014, ..., 600</td></tr> <tr><td>10,0 mm², ..., 95,0 mm²</td><td>B10, ..., B95</td></tr> </table>	Sezione Size	Inserire To be inserted	0,14 mm ² , ..., 6,00 mm ²	014, ..., 600	10,0 mm ² , ..., 95,0 mm ²	B10, ..., B95	<table border="1"> <tr><th>Numero conduttori Number of conductors</th><th>Inserire To be inserted</th></tr> <tr><td>2</td><td>02X</td></tr> <tr><td>3, ..., 61</td><td>03G, ..., 61G</td></tr> </table>	Numero conduttori Number of conductors	Inserire To be inserted	2	02X	3, ..., 61	03G, ..., 61G	<table border="1"> <tr><th>Colore Color</th><th>Inserire To be inserted</th></tr> <tr><td>Grigio - Gray</td><td>GR</td></tr> <tr><td>Nero - Black</td><td>NE</td></tr> </table>	Colore Color	Inserire To be inserted	Grigio - Gray	GR	Nero - Black	NE
Sezione Size	Inserire To be inserted																					
0,14 mm ² , ..., 6,00 mm ²	014, ..., 600																					
10,0 mm ² , ..., 95,0 mm ²	B10, ..., B95																					
Numero conduttori Number of conductors	Inserire To be inserted																					
2	02X																					
3, ..., 61	03G, ..., 61G																					
Colore Color	Inserire To be inserted																					
Grigio - Gray	GR																					
Nero - Black	NE																					

**SERIES
105S**

Cavi multipolari "Flextek-B" antiolio e UV resistant



"Flextek-B" oil-resistant and UV-resistant cables

Posa fissa, schermati - Fixed application, shielded



Impiego - Use

Sono cavi progettati per impiego fisso a bordo macchina o per impieghi mobili occasionali e non ciclici fino a 0,6/1 kV. Vengono normalmente utilizzati per l'equipaggiamento di apparecchiature destinate al mercato Europeo (CE). La loro buona resistenza all'olio ed all'abrasione ne permette l'utilizzo in collegamenti statici senza particolari protezioni e senza che ne vengano compromesse le qualità elettriche e meccaniche originali. Sono ideati per la posa in ambienti industriali interni ed esterni anche in presenza di umidità. La marcatura metrica stampigliata sulla guaina del cavo ne favorisce la lavorazione e l'installazione.

These are machine tool wire cables planned also for occasional non-cyclical mobile uses up to 0,6/1 kV. They are normally used for equipments meant for the European market (EC). Their good oil and abrasion resistance permit their use in static connections without particular protections and without compromising the original electrical and mechanical properties. They are suitable for the installation in dry and damp industrial environments, both indoor and outdoor. The metric marked on the jacket allows an easier processing and installation of the cable.

Informazione. Si effettua, su richiesta, un servizio aggiuntivo di taglio a misura.
Information. An additional cut-to-length service is carried out on request.

Marcatura - Marking

TEKIMA 0105S "FLEXTEK-B" - CE 12G2,5 mm² 600/1000 V - IEC 60332-1-2 - UV RESISTANT - (prod.reference) = (metric) =

Dati tecnici - Technical data

Caratteristica - Characteristics	Valore/proprietà - Value/property
Conduttore <i>Conductor</i>	Trefolo in rame, classe 5 - CEI EN 60228 <i>Copper strand, class 5 - CEI EN 60228</i>
Isolamento <i>Insulation</i>	Mescola di PVC <i>PVC compound</i>
Distinzione conduttori <i>Conductor distinction</i>	Neri numerati + giallo/verde (a partire dai 3 conduttori) <i>Black numbered + yellow/green (beginning from 3 conductors)</i>
Schermatura <i>Shield</i>	Treccia di rame stagnato, ricopertura nom. 85% <i>Tinned copper braid, nom. coverage 85%</i>
Guaina <i>Jacket</i>	Mescola di PVC antiolio e antifiamma, colore grigio RAL 7001 o nero. Marcatura metrica. <i>Oil and flame-resistant PVC compound, RAL 7001 gray color or black. Metric marking.</i>
Temperatura di esercizio <i>Temperature range</i>	-40°C, +80°C (posa fissa); -5°C, +70°C (mobile) <i>-40°C, +80°C (fixed); -5°C, +70°C (not fixed)</i>
Tensione nominale <i>Voltage rating</i>	600/1000 V
Tensione di prova <i>Test voltage</i>	6000 V
Raggio di curvatura <i>Bending radius</i>	6 volte diametro esterno del cavo (posa fissa) 20 volte diametro esterno del cavo (posa mobile non ciclica) <i>6 x cable outer diameter (fixed) 20 x cable outer diameter (not fixed)</i>
Riferimenti normativi costruttivi <i>Standards of construction</i>	Flame res.: IEC 60332-1-2, DIN VDE 0472 part 804 I UV res.: UNI EN ISO 4892-3 (grigio/gray), UNI EN ISO 4892-2 (nero/black) I Other: CEI EN 60228, VDE 0295, CEI 20-11, VDE 0207, 2014/35/EU (Low Voltage Directive), UE 305/2011, EN 50575 (CPR, Class Eca)

* La CPR per questo prodotto è valida in EU, non in UK.

* The CPR for this product is valid in the EU, not in UK.

Codifiche e dimensioni - Coding and dimensions

Codice <i>Code</i>	Numero di conduttori <i>Number of conductors</i>	Sezione <i>Size [mm²]</i>	Diametro <i>Diameter [mm]</i>	Peso <i>Weight [kg/km]</i>	Tensione <i>Voltage [V]</i>
CV02X050_0105S_□□	2	0,5	7,2	70	600/1000
CV02X075_0105S_□□	2	0,75	7,6	78	600/1000
CV02X100_0105S_□□	2	1,0	7,9	85	600/1000
CV02X150_0105S_□□	2	1,5	8,9	109	600/1000
CV02X250_0105S_□□	2	2,5	10,3	149	600/1000
CV02X400_0105S_□□	2	4,0	11,5	194	600/1000
CV02X600_0105S_□□	2	6,0	12,8	251	600/1000
CV03G050_0105S_□□	3	0,5	7,6	81	600/1000
CV03G075_0105S_□□	3	0,75	8,0	92	600/1000
CV03G100_0105S_□□	3	1,0	8,3	106	600/1000
CV03G150_0105S_□□	3	1,5	9,4	133	600/1000
CV03G250_0105S_□□	3	2,5	10,8	190	600/1000
CV03G400_0105S_□□	3	4,0	12,2	252	600/1000
CV03G600_0105S_□□	3	6,0	13,8	346	600/1000
CV03GB10_0105S_□□	3	10	16,9	519	600/1000
CV03GB16_0105S_□□	3	16	19,3	731	600/1000
CV04G050_0105S_□□	4	0,5	8,1	94	600/1000
CV04G075_0105S_□□	4	0,75	8,6	113	600/1000
CV04G100_0105S_□□	4	1,0	8,9	126	600/1000
CV04G150_0105S_□□	4	1,5	10,3	170	600/1000

Code Code	Numero di conduttori Number of conductors	Sezione Size [mm ²]	Diametro Diameter [mm]	Peso Weight [kg/km]	Tensione Voltage [V]
CV04G250_0105S_□□	4	2,5	11,7	230	600/1000
CV04G400_0105S_□□	4	4,0	13,7	331	600/1000
CV04G600_0105S_□□	4	6,0	15,0	427	600/1000
CV04GB10_0105S_□□	4	10	18,5	660	600/1000
CV04GB16_0105S_□□	4	16	21,1	934	600/1000
CV04GB25_0105S_□□	4	25	26,0	1416	600/1000
CV04GB35_0105S_□□	4	35	29,0	1859	600/1000
CV04GB50_0105S_□□	4	50	34,6	2645	600/1000
CV04GB70_0105S_□□	4	70	39,8	3578	600/1000
CV05G050_0105S_□□	5	0,5	8,7	114	600/1000
CV05G075_0105S_□□	5	0,75	9,3	132	600/1000
CV05G100_0105S_□□	5	1,0	9,9	156	600/1000
CV05G150_0105S_□□	5	1,5	11,2	204	600/1000
CV05G250_0105S_□□	5	2,5	13,0	285	600/1000
CV05G400_0105S_□□	5	4,0	14,9	403	600/1000
CV05G600_0105S_□□	5	6,0	16,6	530	600/1000
CV05GB10_0105S_□□	5	10	20,6	828	600/1000
CV05GB16_0105S_□□	5	16	23,4	1160	600/1000
CV05GB25_0105S_□□	5	25	28,9	1770	600/1000
CV05GB35_0105S_□□	5	35	32,5	2357	600/1000
CV07G050_0105S_□□	7	0,5	9,4	133	600/1000
CV07G075_0105S_□□	7	0,75	10,2	165	600/1000
CV07G100_0105S_□□	7	1,0	10,6	186	600/1000
CV07G150_0105S_□□	7	1,5	12,1	251	600/1000
CV07G250_0105S_□□	7	2,5	14,3	371	600/1000
CV07G400_0105S_□□	7	4,0	16,4	515	600/1000
CV07G600_0105S_□□	7	6,0	18,1	672	600/1000
CV12G050_0105S_□□	12	0,5	11,9	206	600/1000
CV12G075_0105S_□□	12	0,75	12,9	255	600/1000
CV12G100_0105S_□□	12	1,0	13,8	303	600/1000
CV12G150_0105S_□□	12	1,5	16,0	421	600/1000
CV12G250_0105S_□□	12	2,5	18,4	585	600/1000
CV18G050_0105S_□□	18	0,5	14,2	309	600/1000
CV18G075_0105S_□□	18	0,75	15,1	366	600/1000
CV18G100_0105S_□□	18	1,0	16,1	434	600/1000
CV18G150_0105S_□□	18	1,5	18,5	583	600/1000
CV18G250_0105S_□□	18	2,5	21,7	843	600/1000
CV25G050_0105S_□□	25	0,5	16,2	394	600/1000
CV25G075_0105S_□□	25	0,75	17,4	480	600/1000
CV25G100_0105S_□□	25	1,0	18,2	550	600/1000
CV25G150_0105S_□□	25	1,5	21,3	764	600/1000
CV25G250_0105S_□□	25	2,5	25,2	1118	600/1000
CV34G050_0105S_□□	34	0,5	18,6	505	600/1000
CV34G075_0105S_□□	34	0,75	20,2	628	600/1000
CV34G100_0105S_□□	34	1,0	21,3	732	600/1000
CV34G150_0105S_□□	34	1,5	25,1	1028	600/1000
CV42G075_0105S_□□	42	0,75	21,6	752	600/1000
CV42G100_0105S_□□	42	1,0	23,0	890	600/1000
CV42G150_0105S_□□	42	1,5	26,9	1239	600/1000
CV50G075_0105S_□□	50	0,75	23,5	860	600/1000
CV50G100_0105S_□□	50	1,0	24,8	1007	600/1000
CV50G150_0105S_□□	50	1,5	29,3	1427	600/1000
CV61G075_0105S_□□	61	0,75	25,2	1020	600/1000
CV61G100_0105S_□□	61	1,0	26,5	1197	600/1000
CV61G150_0105S_□□	61	1,5	31,6	1738	600/1000

Composizione del codice - Code composition

CV □□□ □□□ _0105S_ □□	Colore Color	Inserire To be inserted
Numero conduttori Number of conductors	Grigio - Gray	GR
Inserire To be inserted	Nero - Black	NE
2		
3, ..., 61		
Sezione Size		Inserire To be inserted
0,14 mm ² , ..., 6,00 mm ²		014, ..., 600
10,0 mm ² , ..., 70,0 mm ²		B10, ..., B70

SERIES
150

Cavi multipolari armati "Armatek" antiolio



"Armatek" armoured oil-resistant cables

Posa fissa, non schermati - Fixed application, unshielded

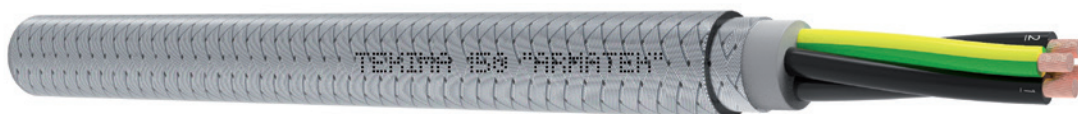

Impiego - Use

Sono cavi di potenza e controllo ideati per utensili, sistemi di condizionamento e sistemi di elaborazione dei dati in ambienti quali, per esempio, stabilimenti industriali e centrali elettriche. L'elevata protezione meccanica e un certo grado di schermatura elettrica sono offerte dalla treccia di acciaio protetta dall'ossidazione e dalla polvere grazie ad una seconda guaina trasparente esterna. Questi cavi sono impiegati in applicazioni di posa fissa ma anche per applicazioni di posa mobile con movimenti scarsamente ripetitivi. La marcatura metrica stampigliata sulla guaina del cavo ne favorisce la lavorazione e l'installazione.

These cables are suitable as power supply and connection control cables, for machine tool, power stations, air conditioning systems as well as data processing systems. High mechanical protection and a defined degree of electrical shielding is provided by the oxidation protected steel wire braiding under the transparent outer sheath which protects the braid against dirt. They are suitable for fixed installation but also for flexible applications under conditions of not continuously movement. The metric marked on the jacket allows an easier processing and installation of the cable.

Informazione. Si effettua, su richiesta, un servizio aggiuntivo di taglio a misura.
Information. An additional cut-to-length service is carried out on request.

Dati tecnici - Technical data

Caratteristica - Characteristics	Valore/proprietà - Value/property
Conduttore <i>Conductor</i>	Trefolo in rame, classe 5 - CEI EN 60228 <i>Copper strand, class 5 - CEI EN 60228</i>
Isolamento <i>Insulation</i>	Mescola di PVC <i>PVC compound</i>
Distinzione conduttori <i>Conductor distinction</i>	Neri numerati + giallo/verde (a partire dai 3 conduttori) <i>Black numbered + yellow/green (beginning from 3 conductors)</i>
Guaina interna <i>Inner jacket</i>	Mescola di PVC antiolio e antifiama, colore grigio RAL 7001. Marcatura metrica. <i>Oil and flame-resistant PVC compound, RAL 7001 gray color. Metric marking.</i>
Armatura <i>Armour</i>	Treccia di acciaio, ricopertura 65% <i>Steel braid, coverage 65%</i>
Guaina esterna <i>Outer jacket</i>	Mescola di PVC antiolio e antifiama, trasparente <i>Oil and flame-resistant PVC compound, transparent</i>
Temperatura di esercizio <i>Temperature range</i>	-40°C, +70°C (posa fissa); -5°C, +80°C (mobile) <i>-40°C, +70°C (fixed); -5°C, +80°C (not fixed)</i>
Tensione nominale <i>Voltage rating</i>	600/1000 V
Tensione di prova <i>Test voltage</i>	6000 V
Raggio di curvatura <i>Bending radius</i>	12 volte diametro esterno del cavo <i>12 x cable outer diameter</i>
Riferimenti normativi costruttivi <i>Standards of construction</i>	Flame res.: IEC 60332-1-2 Other: CEI 20-11, VDE 0207, CEI EN 60228, VDE 0295, 2006/95/EC (Low Voltage Directive)

Marcatura - Marking

TEKIMA 01500 "ARMATEK" - CE 4G1 mm² 600/1000 V - IEC 60332-1-2 - ARMoured - (prod.reference) = (metric) =

Codifiche e dimensioni - Coding and dimensions

Codice <i>Code</i>	Numero di conduttori <i>Number of conductors</i>	Sezione <i>Size [mm²]</i>	Diametro <i>Diameter [mm]</i>	Peso <i>Weight [kg/km]</i>	Tensione <i>Voltage [V]</i>
CV02X050_01500_TR	2	0,5	10,1	133	600/1000
CV02X075_01500_TR	2	0,75	10,5	146	600/1000
CV02X100_01500_TR	2	1	10,9	157	600/1000
CV02X150_01500_TR	2	1,5	11,9	198	600/1000
CV02X250_01500_TR	2	2,5	13,1	245	600/1000
CV02X400_01500_TR	2	4	14,4	317	600/1000
CV02X600_01500_TR	2	6	15,8	390	600/1000
CV03G050_01500_TR	3	0,5	10,5	146	600/1000
CV03G075_01500_TR	3	0,75	10,9	170	600/1000
CV03G100_01500_TR	3	1	11,3	183	600/1000
CV03G150_01500_TR	3	1,5	12,4	222	600/1000
CV03G250_01500_TR	3	2,5	13,7	292	600/1000
CV03G400_01500_TR	3	4	15,4	376	600/1000
CV03G600_01500_TR	3	6	16,6	475	600/1000
CV03GB10_01500_TR	3	10	19,7	697	600/1000

Codice Code	Numero di conduttori Number of conductors	Sezione Size [mm ²]	Diametro Diameter [mm]	Peso Weight [kg/km]	Tensione Voltage [V]
CV03GB16_01500_TR	3	16	21,9	926	600/1000
CV03GB50_01500_TR	3	50	33,8	2151	600/1000
CV04G050_01500_TR	4	0,5	11,1	171	600/1000
CV04G075_01500_TR	4	0,75	11,5	190	600/1000
CV04G100_01500_TR	4	1	11,9	205	600/1000
CV04G150_01500_TR	4	1,5	13,2	252	600/1000
CV04G250_01500_TR	4	2,5	14,9	346	600/1000
CV04G400_01500_TR	4	4	16,5	458	600/1000
CV04G600_01500_TR	4	6	17,8	563	600/1000
CV04GB10_01500_TR	4	10	21,3	840	600/1000
CV04GB16_01500_TR	4	16	23,7	1145	600/1000
CV04GB25_01500_TR	4	25	28,6	1695	600/1000
CV04GB35_01500_TR	4	35	31,7	2204	600/1000
CV04GB50_01500_TR	4	50	37,3	3087	600/1000
CV04GB70_01500_TR	4	70	42,8	4163	600/1000
CV05G050_01500_TR	5	0,5	11,7	190	600/1000
CV05G075_01500_TR	5	0,75	12,3	213	600/1000
CV05G100_01500_TR	5	1	12,7	233	600/1000
CV05G150_01500_TR	5	1,5	14,1	304	600/1000
CV05G250_01500_TR	5	2,5	16	416	600/1000
CV05G400_01500_TR	5	4	17,8	532	600/1000
CV05G600_01500_TR	5	6	19,3	684	600/1000
CV05GB10_01500_TR	5	10	23,2	1019	600/1000
CV05GB16_01500_TR	5	16	26	1400	600/1000
CV05GB25_01500_TR	5	25	31,6	2095	600/1000
CV05GB35_01500_TR	5	35	35,2	2732	600/1000
CV07G050_01500_TR	7	0,5	12,4	215	600/1000
CV07G075_01500_TR	7	0,75	13	243	600/1000
CV07G100_01500_TR	7	1	13,5	277	600/1000
CV07G150_01500_TR	7	1,5	15,3	363	600/1000
CV07G250_01500_TR	7	2,5	17,1	491	600/1000
CV07G400_01500_TR	7	4	19,1	662	600/1000
CV07G600_01500_TR	7	6	20,8	835	600/1000
CV07GB10_01500_TR	7	10	25,2	1266	600/1000
CV07GB16_01500_TR	7	16	28,4	1766	600/1000
CV07GB25_01500_TR	7	25	34,6	2679	600/1000
CV10G050_01500_TR	10	0,5	14,5	298	600/1000
CV10G075_01500_TR	10	0,75	15,5	351	600/1000
CV10G100_01500_TR	10	1	16,2	404	600/1000
CV10G150_01500_TR	10	1,5	18,2	512	600/1000
CV10G250_01500_TR	10	2,5	20,6	708	600/1000
CV12G050_01500_TR	12	0,5	15,1	324	600/1000
CV12G075_01500_TR	12	0,75	15,9	387	600/1000
CV12G100_01500_TR	12	1	16,6	432	600/1000
CV12G150_01500_TR	12	1,5	18,7	553	600/1000
CV12G250_01500_TR	12	2,5	21,2	767	600/1000
CV14G050_01500_TR	14	0,5	15,6	348	600/1000
CV14G075_01500_TR	14	0,75	16,5	418	600/1000
CV14G100_01500_TR	14	1	17,2	468	600/1000
CV14G150_01500_TR	14	1,5	19,4	626	600/1000
CV14G250_01500_TR	14	2,5	22,1	845	600/1000
CV16G050_01500_TR	16	0,5	16,2	391	600/1000
CV16G075_01500_TR	16	0,75	17,2	451	600/1000
CV16G100_01500_TR	16	1	17,9	505	600/1000
CV16G150_01500_TR	16	1,5	20,3	682	600/1000
CV16G250_01500_TR	16	2,5	23,1	946	600/1000
CV18G050_01500_TR	18	0,5	17	426	600/1000
CV18G075_01500_TR	18	0,75	18	492	600/1000
CV18G100_01500_TR	18	1	18,8	555	600/1000

Cavi multipolari per posa fissa - Cables for fixed applications

Codice <i>Code</i>	Numero di conduttori <i>Number of conductors</i>	Sezione <i>Size [mm²]</i>	Diametro <i>Diameter [mm]</i>	Peso <i>Weight [kg/km]</i>	Tensione <i>Voltage [V]</i>
CV18G150_01500_TR	18	1,5	21,3	750	600/1000
CV18G250_01500_TR	18	2,5	24,4	1054	600/1000
CV21G050_01500_TR	21	0,5	18,2	480	600/1000
CV21G075_01500_TR	21	0,75	19,4	583	600/1000
CV21G100_01500_TR	21	1	20,2	658	600/1000
CV21G150_01500_TR	21	1,5	23	881	600/1000
CV25G050_01500_TR	25	0,5	18,9	522	600/1000
CV25G075_01500_TR	25	0,75	20,1	638	600/1000
CV25G100_01500_TR	25	1	21	719	600/1000
CV25G150_01500_TR	25	1,5	24	970	600/1000
CV25G250_01500_TR	25	2,5	27,7	1379	600/1000
CV34G050_01500_TR	34	0,5	21,4	683	600/1000
CV34G075_01500_TR	34	0,75	22,9	825	600/1000
CV34G100_01500_TR	34	1	24	941	600/1000
CV34G150_01500_TR	34	1,5	27,6	1292	600/1000
CV34G250_01500_TR	34	2,5	32,2	1872	600/1000
CV37G075_01500_TR	37	0,75	22,9	841	600/1000
CV37G100_01500_TR	37	1	24	961	600/1000
CV37G150_01500_TR	37	1,5	27,6	1323	600/1000
CV42G075_01500_TR	42	0,75	24,3	950	600/1000
CV42G100_01500_TR	42	1	25,5	1104	600/1000
CV42G150_01500_TR	42	1,5	29,6	1527	600/1000
CV50G075_01500_TR	50	0,75	26,1	1103	600/1000
CV50G100_01500_TR	50	1	27,5	1270	600/1000
CV50G150_01500_TR	50	1,5	32	1776	600/1000
CV61G075_01500_TR	61	0,75	27,7	1255	600/1000
CV61G100_01500_TR	61	1	29,2	1465	600/1000
CV61G150_01500_TR	61	1,5	34,1	2061	600/1000

Composizione del codice - Code composition

CV		_01500_		Colore <i>Color</i>	Inserire <i>To be inserted</i>
Numero conduttori <i>Number of conductors</i>	Inserire <i>To be inserted</i>	Sezione <i>Size</i>	Inserire <i>To be inserted</i>	Trasparente - <i>Transparent</i>	TR
2	02X	0,14 mm ² , ..., 6,00 mm ²	014, ..., 600		
3, ..., 61	03G, ..., 61G	10,0 mm ² , ..., 70,0 mm ²	B10, ..., B70		

**SERIES
150S**

Cavi multipolari armati "Armatek" antiolio



"Armatek" armoured oil-resistant cables

Posa fissa, schermati - Fixed application, shielded

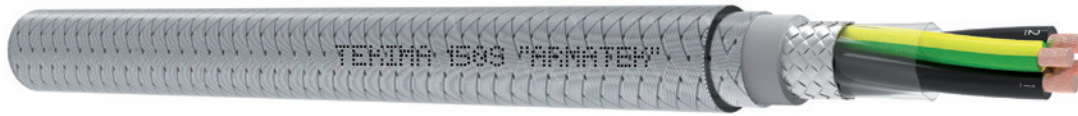

Impiego - Use

Sono cavi di potenza e controllo idonei per utensili, sistemi di condizionamento e sistemi di elaborazione dei dati in ambienti quali, per esempio, stabilimenti industriali e centrali elettriche. L'elevata protezione meccanica è offerta dalla treccia di acciaio protetta dall'ossidazione e dalla polvere grazie ad una seconda guaina trasparente esterna. Questi cavi sono impiegati in applicazioni di posa fissa ma anche per applicazioni di posa mobile con movimenti scarsamente ripetitivi. La marcatura metrica stampigliata sulla guaina del cavo ne favorisce la lavorazione e l'installazione.

These cables are suitable as power supply and connection control cables, for machine tool, power stations, air conditioning systems as well as data processing systems. High mechanical protection is provided by the oxidation protected steel wire braiding under the transparent outer sheath which protects the braid against dirt. They are suitable for fixed installation but also for flexible applications under conditions of not continuously movement. The metric marked on the jacket allows an easier processing and installation of the cable.

Informazione. Si effettua, su richiesta, un servizio aggiuntivo di taglio a misura.
Information. An additional cut-to-length service is carried out on request.

Dati tecnici - Technical data

Caratteristica - Characteristics	Valore/proprietà - Value/property
Conduttore <i>Conductor</i>	Trefolo in rame, classe 5 <i>Copper strand, class 5</i>
Isolamento <i>Insulation</i>	Mescola di PVC <i>PVC compound</i>
Distinzione conduttori <i>Conductor distinction</i>	Neri numerati + giallo/verde (a partire dai 3 conduttori) <i>Black numbered + yellow/green (beginning from 3 conductors)</i>
Schermatura <i>Shield</i>	Treccia di rame stagnato, ricopertura nom. 85% <i>Tinned copper braid, nom. coverage 85%</i>
Guaina interna <i>Inner jacket</i>	Mescola di PVC antiolio e antifiamma, colore grigio RAL 7001. Marcatura metrica. <i>Oil and flame-resistant PVC compound, RAL 7001 gray color. Metric marking.</i>
Armatura <i>Armour</i>	Treccia di acciaio, ricopertura 65% <i>Steel braid, coverage 65%</i>
Guaina esterna <i>Outer jacket</i>	Mescola di PVC antiolio e antifiamma, trasparente <i>Oil and flame-resistant PVC compound, transparent</i>
Temperatura di esercizio <i>Temperature range</i>	-40°C, +70°C (posa fissa); -5°C, +80°C (mobile) <i>-40°C, +70°C (fixed); -5°C, +80°C (not fixed)</i>
Tensione nominale <i>Voltage rating</i>	600/1000 V
Tensione di prova <i>Test voltage</i>	6000 V
Raggio di curvatura <i>Bending radius</i>	12,5 volte diametro esterno del cavo <i>12,5 x cable outer diameter</i>
Riferimenti normativi costruttivi <i>Standards of construction</i>	Flame res.: IEC 60332-1-2 Other: CEI 20-11, VDE 0207, CEI EN 60228, VDE 0295, 2006/95/EC (Low Voltage Directive)

Marcatura - Marking

TEKIMA 0150S "ARMATEK" – CE 4G1 mm² 600/1000 V – IEC 60332-1-2 – ARMOURED – (prod.reference) = (metric) =

Codifiche e dimensioni - Coding and dimensions

Codice <i>Code</i>	Numero di conduttori <i>Number of conductors</i>	Sezione <i>Size [mm²]</i>	Diametro <i>Diameter [mm]</i>	Peso <i>Weight [kg/km]</i>	Tensione <i>Voltage [V]</i>
CV04G250_0150S_TR	4	2,5	15,5	399	600/1000
CV04G400_0150S_TR	4	4	17,3	510	600/1000
CV04G600_0150S_TR	4	6	18,7	631	600/1000
CV04GB10_0150S_TR	4	10	22,1	911	600/1000
CV04GB16_0150S_TR	4	16	24,6	1164	600/1000
CV04GB25_0150S_TR	4	25	29,7	1738	600/1000
CV04GB35_0150S_TR	4	35	32,9	2218	600/1000
CV04GB50_0150S_TR	4	50	38,4	3102	600/1000

Composizione del codice - Code composition

Numero conduttori <i>Number of conductors</i>	Inserire <i>To be inserted</i>	Sezione <i>Size</i>	Inserire <i>To be inserted</i>	Colore <i>Color</i>	Inserire <i>To be inserted</i>
4	04G	2,50 mm ² , ..., 6,00 mm ²	025, ..., 600	Trasparente - <i>Transparent</i>	TR
		10,0 mm ² , ..., 50,0 mm ²	B10, ..., B50		

SERIES
151

Cavi multipolari armati "Armatek" antiolio



"Armatek" armoured oil-resistant cables

Posa fissa, non schermati - Fixed application, unshielded



Impiego - Use

Sono cavi di potenza e controllo ideati per utensili, sistemi di condizionamento e sistemi di elaborazione dei dati in ambienti quali, per esempio, stabilimenti industriali e centrali elettriche. L'elevata protezione meccanica è offerta dalla treccia di acciaio protetta dall'ossidazione e dalla polvere grazie ad una seconda guaina trasparente esterna. Questi cavi sono impiegati in applicazioni di posa fissa ma anche per applicazioni di posa mobile con movimenti scarsamente ripetitivi. La marcatura metrica stampigliata sulla guaina del cavo ne favorisce la lavorazione e l'installazione.

These cables are suitable as power supply and connection control cables, for machine tool, power stations, air conditioning systems as well as data processing systems. High mechanical protection is provided by the oxidation protected steel wire braiding under the transparent outer sheath which protects the braid against dirt. They are suitable for fixed installation but also for flexible applications under conditions of not continuously movement. The metric marked on the jacket allows an easier processing and installation of the cable.

Informazione. Si effettua, su richiesta, un servizio aggiuntivo di taglio a misura.
Information. An additional cut-to-length service is carried out on request.

Dati tecnici - Technical data

Caratteristica - Characteristics	Valore/proprietà - Value/property
Conduttore <i>Conductor</i>	Trefolo in rame, classe 5 <i>Copper strand, class 5</i>
Isolamento <i>Insulation</i>	Mescola di PVC <i>PVC compound</i>
Distinzione conduttori <i>Conductor distinction</i>	Neri numerati + giallo/verde (a partire dai 3 conduttori) <i>Black numbered + yellow/green (beginning from 3 conductors)</i>
Guaina interna <i>Inner jacket</i>	Mescola di PVC antiolio e antifiamma, colore grigio RAL 7001. Marcatura metrica. <i>Oil and flame-resistant PVC compound, RAL 7001 gray color. Metric marking.</i>
Armatura <i>Armour</i>	Treccia di acciaio, ricopertura 65% <i>Steel braid, coverage 65%</i>
Guaina esterna <i>Outer jacket</i>	Mescola di PVC antiolio e antifiamma, trasparente <i>Oil and flame-resistant PVC compound, transparent</i>
Temperatura di esercizio <i>Temperature range</i>	-40°C, +70°C (posa fissa); -5°C, +80°C (mobile) <i>-40°C, +70°C (fixed); -5°C, +80°C (not fixed)</i>
Tensione nominale <i>Voltage rating</i>	300/500 V
Tensione di prova <i>Test voltage</i>	3000 V
Raggio di curvatura <i>Bending radius</i>	12,5 volte diametro esterno del cavo <i>12,5 x cable outer diameter</i>
Riferimenti normativi costruttivi <i>Standards of construction</i>	Flame res.: IEC 60332-1-2 Other: CEI 20-11, VDE 0207, CEI EN 60228, VDE 0295, 2006/95/EC (Low Voltage Directive)

Marcatura - Marking

TEKIMA 01510 "ARMAK" - CE 4G1 mm² 300/500 V - IEC 60332-1-2 - ARMORED - (prod.reference) = (metric) =

Codifiche e dimensioni - Coding and dimensions

Codice <i>Code</i>	Numero di conduttori <i>Number of conductors</i>	Sezione <i>Size [mm²]</i>	Diametro <i>Diameter [mm]</i>	Peso <i>Weight [kg/km]</i>	Tensione <i>Voltage [V]</i>
CV02X050_01510_TR	2	0,5	7,2	83	300/500
CV02X075_01510_TR	2	0,75	7,6	93	300/500
CV02X100_01510_TR	2	1	7,9	101	300/500
CV02X150_01510_TR	2	1,5	8,7	123	300/500
CV02X250_01510_TR	2	2,5	10,1	175	300/500
CV02X400_01510_TR	2	4	11,6	241	300/500
CV02X600_01510_TR	2	6	13,4	328	300/500
CV03X050_01510_TR	3	0,5	7,5	91	300/500
CV03G075_01510_TR	3	0,75	7,9	103	300/500
CV03G100_01510_TR	3	1	8,5	119	300/500
CV03G150_01510_TR	3	1,5	9,1	151	300/500
CV03G250_01510_TR	3	2,5	10,6	204	300/500
CV03G400_01510_TR	3	4	12,3	287	300/500
CV03G600_01510_TR	3	6	14,1	391	300/500
CV03GB10_01510_TR	3	10	17,3	595	300/500

Codice Code	Numero di conduttori Number of conductors	Sezione Size [mm ²]	Diametro Diameter [mm]	Peso Weight [kg/km]	Tensione Voltage [V]
CV03GB16_01510_TR	3	16	20	866	300/500
CV04G050_01510_TR	4	0,5	7,9	101	300/500
CV04G075_01510_TR	4	0,75	8,6	121	300/500
CV04G100_01510_TR	4	1	9	135	300/500
CV04G150_01510_TR	4	1,5	9,9	178	300/500
CV04G250_01510_TR	4	2,5	11,5	253	300/500
CV04G400_01510_TR	4	4	13,5	358	300/500
CV04G600_01510_TR	4	6	15,4	485	300/500
CV04GB10_01510_TR	4	10	19,3	778	300/500
CV04GB16_01510_TR	4	16	21,8	1077	300/500
CV04GB25_01510_TR	4	25	26,9	1623	300/500
CV04GB35_01510_TR	4	35	30,3	2149	300/500
CV05G050_01510_TR	5	0,5	8,7	119	300/500
CV05G075_01510_TR	5	0,75	9,2	147	300/500
CV05G100_01510_TR	5	1	9,6	164	300/500
CV05G150_01510_TR	5	1,5	10,6	204	300/500
CV05G250_01510_TR	5	2,5	12,6	299	300/500
CV05G400_01510_TR	5	4	14,7	424	300/500
CV05G600_01510_TR	5	6	16,9	580	300/500
CV05GB10_01510_TR	5	10	21,2	933	300/500
CV05GB16_01510_TR	5	16	24,4	1339	300/500
CV05GB25_01510_TR	5	25	29,8	2014	300/500
CV05GB35_01510_TR	5	35	33,6	2648	300/500
CV06G050_01510_TR	6	0,5	9,2	142	300/500
CV06G075_01510_TR	6	0,75	10	169	300/500
CV06G100_01510_TR	6	1	10,4	188	300/500
CV06G150_01510_TR	6	1,5	11,5	246	300/500
CV07G050_01510_TR	7	0,5	9,2	145	300/500
CV07G075_01510_TR	7	0,75	10	174	300/500
CV07G100_01510_TR	7	1	10,4	195	300/500
CV07G150_01510_TR	7	1,5	11,5	256	300/500
CV07G250_01510_TR	7	2,5	13,7	375	300/500
CV07G400_01510_TR	7	4	16	534	300/500
CV07G600_01510_TR	7	6	18,7	745	300/500
CV07GB10_01510_TR	7	10	23	1177	300/500
CV07GB16_01510_TR	7	16	26,8	1702	300/500
CV07GB25_01510_TR	7	25	32,9	2599	300/500
CV08G050_01510_TR	8	0,5	10,5	176	300/500
CV08G075_01510_TR	8	0,75	11,4	221	300/500
CV08G100_01510_TR	8	1	12,1	253	300/500
CV08G150_01510_TR	8	1,5	13,4	328	300/500
CV08G250_01510_TR	8	2,5	15,9	475	300/500
CV09G050_01510_TR	9	0,5	10,9	189	300/500
CV09G075_01510_TR	9	0,75	11,8	236	300/500
CV09G100_01510_TR	9	1	12,6	273	300/500
CV09G150_01510_TR	9	1,5	13,9	353	300/500
CV09G250_01510_TR	9	2,5	16,6	518	300/500
CV10G050_01510_TR	10	0,5	11	195	300/500
CV10G075_01510_TR	10	0,75	12,2	252	300/500
CV10G100_01510_TR	10	1	13	291	300/500
CV10G150_01510_TR	10	1,5	14,4	379	300/500
CV10G250_01510_TR	10	2,5	16,9	546	300/500
CV11G150_01510_TR	11	1,5	14,4	390	300/500
CV11G400_01510_TR	11	4	20,3	850	300/500
CV12G050_01510_TR	12	0,5	11,5	224	300/500
CV12G075_01510_TR	12	0,75	12,5	270	300/500
CV12G100_01510_TR	12	1	13,3	314	300/500
CV12G150_01510_TR	12	1,5	14,7	410	300/500
CV12G250_01510_TR	12	2,5	17,6	608	300/500

Cavi multipolari per posa fissa - Cables for fixed applications

Codice Code	Numero di conduttori Number of conductors	Sezione Size [mm ²]	Diametro Diameter [mm]	Peso Weight [kg/km]	Tensione Voltage [V]
CV12G400_01510_TR	12	4	21	911	300/500
CV14G050_01510_TR	14	0,5	12,1	246	300/500
CV14G075_01510_TR	14	0,75	13,2	300	300/500
CV14G100_01510_TR	14	1	13,8	352	300/500
CV14G150_01510_TR	14	1,5	15,3	451	300/500
CV14G250_01510_TR	14	2,5	18,5	689	300/500
CV15G075_01510_TR	15	0,75	13,5	324	300/500
CV16G050_01510_TR	16	0,5	12,6	266	300/500
CV16G075_01510_TR	16	0,75	13,7	335	300/500
CV16G100_01510_TR	16	1	14,6	391	300/500
CV16G150_01510_TR	16	1,5	16,2	513	300/500
CV16G250_01510_TR	16	2,5	19,7	797	300/500
CV18G050_01510_TR	18	0,5	13,4	306	300/500
CV18G075_01510_TR	18	0,75	14,6	374	300/500
CV18G100_01510_TR	18	1	15,3	427	300/500
CV18G150_01510_TR	18	1,5	17	563	300/500
CV18G250_01510_TR	18	2,5	20,9	887	300/500
CV19G050_01510_TR	19	0,5	13,4	309	300/500
CV19G075_01510_TR	19	0,75	14,6	379	300/500
CV19G100_01510_TR	19	1	15,3	434	300/500
CV19G150_01510_TR	19	1,5	17	574	300/500
CV20G100_01510_TR	20	1	16,2	482	300/500
CV21G050_01510_TR	21	0,5	14,6	353	300/500
CV21G075_01510_TR	21	0,75	15,6	432	300/500
CV21G100_01510_TR	21	1	16,7	507	300/500
CV21G150_01510_TR	21	1,5	18,7	672	300/500
CV24G075_01510_TR	24	0,75	16,4	476	300/500
CV24G100_01510_TR	24	1	17,5	559	300/500
CV24G150_01510_TR	24	1,5	19,8	773	300/500
CV25G050_01510_TR	25	0,5	15,1	383	300/500
CV25G075_01510_TR	25	0,75	16,5	485	300/500
CV25G100_01510_TR	25	1	17,5	566	300/500
CV25G150_01510_TR	25	1,5	19,8	783	300/500
CV25G250_01510_TR	25	2,5	23,9	1175	300/500
CV26G075_01510_TR	26	0,75	16,8	501	300/500
CV26G100_01510_TR	26	1	18,1	606	300/500
CV26G150_01510_TR	26	1,5	20,3	816	300/500
CV27G050_01510_TR	27	0,5	16	431	300/500
CV27G075_01510_TR	27	0,75	17,4	529	300/500
CV27G100_01510_TR	27	1	18,5	629	300/500
CV27G150_01510_TR	27	1,5	21	859	300/500
CV30G050_01510_TR	30	0,5	16,2	448	300/500
CV30G075_01510_TR	30	0,75	17,7	566	300/500
CV30G150_01510_TR	30	1,5	21,3	904	300/500
CV32G050_01510_TR	32	0,5	16,5	466	300/500
CV32G075_01510_TR	32	0,75	18,2	596	300/500
CV32G100_01510_TR	32	1	19,6	732	300/500
CV32G150_01510_TR	32	1,5	21,7	960	300/500
CV34G050_01510_TR	34	0,5	17,5	511	300/500
CV34G075_01510_TR	34	0,75	19,5	683	300/500
CV34G100_01510_TR	34	1	20,7	795	300/500
CV34G150_01510_TR	34	1,5	23	1046	300/500
CV34G250_01510_TR	34	2,5	28,1	1610	300/500
CV36G075_01510_TR	36	0,75	19,5	693	300/500
CV36G100_01510_TR	36	1	20,7	809	300/500
CV37G075_01510_TR	37	0,75	19,5	698	300/500
CV37G100_01510_TR	37	1	20,7	816	300/500
CV37G150_01510_TR	37	1,5	23	1077	300/500
CV41G100_01510_TR	41	1	22,2	930	300/500

Codice <i>Code</i>	Numero di conduttori <i>Number of conductors</i>	Sezione <i>Size [mm²]</i>	Diametro <i>Diameter [mm]</i>	Peso <i>Weight [kg/km]</i>	Tensione <i>Voltage [V]</i>
CV41G150_01510_TR	41	1,5	24,8	1231	300/500
CV42G075_01510_TR	42	0,75	20,8	783	300/500
CV42G100_01510_TR	42	1	22,2	937	300/500
CV42G150_01510_TR	42	1,5	24,8	1241	300/500
CV50G075_01510_TR	50	0,75	22,4	916	300/500
CV50G100_01510_TR	50	1	23,9	1080	300/500
CV50G150_01510_TR	50	1,5	27	1454	300/500
CV61G075_01510_TR	61	0,75	23,9	1051	300/500
CV61G100_01510_TR	61	1	25,6	1265	300/500
CV61G150_01510_TR	61	1,5	28,6	1685	300/500

Composizione del codice - Code composition

CV		_01510_		Colore <i>Color</i>	Inserire <i>To be inserted</i>
Numero conduttori <i>Number of conductors</i>	Inserire <i>To be inserted</i>	Sezione <i>Size</i>	Inserire <i>To be inserted</i>	Trasparente - <i>Transparent</i>	TR
2	02X	0,14 mm ² , ..., 6,00 mm ²	014, ..., 600		
3, ..., 61	03G, ..., 61G	10,0 mm ² , ..., 35,0 mm ²	B10, ..., B35		

**SERIES
200**

Cavi multipolari "Flextek-PUR" antiolio ad alte prestazioni



"Flextek-PUR" oil-resistant high performing cables

Posa fissa, non schermati - Fixed application, unshielded



Impiego - Use

Sono cavi ad alte prestazioni meccaniche resistenti agli olii e alla fiamma e progettati per impiego fisso a bordo macchina o per impieghi mobili occasionali e non ciclici. Vengono normalmente utilizzati per l'equipaggiamento di apparecchiature destinate al mercato Europeo (CE). L'eccellente resistenza all'abrasione ne permette l'utilizzo in collegamenti statici senza particolari protezioni e senza che ne vengano compromesse le qualità elettriche e meccaniche originali. Sono idonei alla posa in ambienti industriali interni ed esterni anche in presenza di umidità e raggi UV. La marcatura metrica stampigliata sulla guaina del cavo ne favorisce la lavorazione e l'installazione.

These are oil resistant and flame resistant high performing machine tool wire cables planned also for occasional non-cyclical mobile uses. They are normally used for equipment meant for the European market (EC). Their excellent abrasion resistance permit their use in static connections without particular protections and without compromising the original electrical and mechanical properties. They are suitable for indoor and outdoor installations in dry and damp environments also exposed to UV rays. The metric marked on the jacket allows an easier processing and installation of the cable.

Informazione. Si effettua, su richiesta, un servizio aggiuntivo di taglio a misura.
Information. An additional cut-to-length service is carried out on request.

Dati tecnici - Technical data

Caratteristica - Characteristics	Valore/proprietà - Value/property
Conduttore <i>Conductor</i>	Trefolo in rame, classe 5 - CEI EN 60228 <i>Copper strand, class 5 - CEI EN 60228</i>
Isolamento <i>Insulation</i>	Mescola di PVC <i>PVC compound</i>
Distinzione conduttori <i>Conductor distinction</i>	Neri numerati + giallo/verde (a partire dai 3 conduttori) <i>Black numbered + yellow/green (beginning from 3 conductors)</i>
Guaina <i>Jacket</i>	Mescola di PUR antiolio e antifiama, colore grigio RAL 7001. Marcatura metrica. <i>Oil and flame-resistant PUR compound, RAL 7001 gray color. Metric marking.</i>
Temperatura di esercizio <i>Temperature range</i>	-40°C, +80°C (posa fissa); -5°C, +70°C (mobile) <i>-40°C, +80°C (fixed); -5°C, +70°C (not fixed)</i>
Tensione nominale <i>Voltage rating</i>	300/500 V
Tensione di prova <i>Test voltage</i>	3000 V
Raggio di curvatura <i>Bending radius</i>	4 volte diametro esterno del cavo (posa fissa); 12,5 volte diametro esterno del cavo (mobile) <i>4 x cable outer diameter (fixed); 12,5 x cable outer diameter (mobile)</i>
Riferimenti normativi costruttivi <i>Standards of construction</i>	Flame res.: IEC 60332-1-2, DIN VDE 0472 I UV res.: UNI EN ISO 4892-3 (grigio/gray), UNI EN ISO 4892-2 (nero/black) Other: CEI 20-11, VDE 0207, CEI EN 60228, VDE 0295, LVD 2006/95/EC (Low Voltage Directive)

Marcatura - Marking

TEKIMA 02000 "FLEXTEK-PUR" - CE 12G2,5 mm² 300/500 V - IEC 60332-1-2 - (prod.reference) = (metric) =

Codifiche e dimensioni - Coding and dimensions

Codice <i>Code</i>	Numero <i>Number</i>	Sezione <i>Size [mm²]</i>	Diametro <i>Diameter [mm]</i>	Peso <i>Weight [kg/km]</i>	Tensione <i>Voltage [V]</i>
CV02X050_02000_□□	2	0,5	5	29	300/500
CV02X075_02000_□□	2	0,75	5,4	36	300/500
CV02X100_02000_□□	2	1	5,7	43	300/500
CV02X150_02000_□□	2	1,5	6,3	56	300/500
CV02X250_02000_□□	2	2,5	7,7	88	300/500
CV03G050_02000_□□	3	0,5	5,3	36	300/500
CV03G075_02000_□□	3	0,75	5,7	46	300/500
CV03G100_02000_□□	3	1	6,1	55	300/500
CV03G150_02000_□□	3	1,5	6,7	73	300/500
CV03G250_02000_□□	3	2,5	8,2	114	300/500
CV03G400_02000_□□	3	4	9,7	172	300/500
CV03G600_02000_□□	3	6	11,5	250	300/500
CV03GB10_02000_□□	3	10	14,5	407	300/500
CV03GB16_02000_□□	3	16	17	607	300/500
CV04G050_02000_□□	4	0,5	5,7	44	300/500
CV04G075_02000_□□	4	0,75	6,2	57	300/500
CV04G100_02000_□□	4	1	6,6	68	300/500
CV04G150_02000_□□	4	1,5	7,5	94	300/500

Codice Code	Numero Number	Sezione Size [mm ²]	Diametro Diameter [mm]	Peso Weight [kg/km]	Tensione Voltage [V]
CV04G250_02000_□□	4	2,5	9,1	148	300/500
CV04G400_02000_□□	4	4	10,9	223	300/500
CV04G600_02000_□□	4	6	12,8	324	300/500
CV04GB10_02000_□□	4	10	16,3	531	300/500
CV04GB16_02000_□□	4	16	19	792	300/500
CV04GB25_02000_□□	4	25	23,7	1233	300/500
CV04GB35_02000_□□	4	35	26,9	1669	300/500
CV05G050_02000_□□	5	0,5	6,3	54	300/500
CV05G075_02000_□□	5	0,75	6,8	70	300/500
CV05G100_02000_□□	5	1	7,2	84	300/500
CV05G150_02000_□□	5	1,5	8,2	115	300/500
CV05G250_02000_□□	5	2,5	10	182	300/500
CV05G400_02000_□□	5	4	12,1	279	300/500
CV05G600_02000_□□	5	6	14,3	405	300/500
CV05GB10_02000_□□	5	10	18,2	662	300/500
CV05GB16_02000_□□	5	16	21,2	987	300/500
CV07G050_02000_□□	7	0,5	6,8	69	300/500
CV07G075_02000_□□	7	0,75	7,6	92	300/500
CV07G100_02000_□□	7	1	8	111	300/500
CV07G150_02000_□□	7	1,5	9,1	153	300/500
CV07G250_02000_□□	7	2,5	11,1	242	300/500
CV07G400_02000_□□	7	4	13,4	370	300/500
CV07G600_02000_□□	7	6	15,9	539	300/500
CV07GB10_02000_□□	7	10	20	880	300/500
CV12G050_02000_□□	12	0,5	9,1	121	300/500
CV12G075_02000_□□	12	0,75	9,9	157	300/500
CV12G100_02000_□□	12	1	10,7	193	300/500
CV12G150_02000_□□	12	1,5	12,1	266	300/500
CV12G250_02000_□□	12	2,5	15	424	300/500
CV18G050_02000_□□	18	0,5	10,8	175	300/500
CV18G075_02000_□□	18	0,75	12	232	300/500
CV18G100_02000_□□	18	1	12,7	281	300/500
CV18G150_02000_□□	18	1,5	14,4	388	300/500
CV18G250_02000_□□	18	2,5	17,9	624	300/500
CV25G050_02000_□□	25	0,5	12,5	238	300/500
CV25G075_02000_□□	25	0,75	13,9	316	300/500
CV25G100_02000_□□	25	1	14,9	389	300/500
CV25G150_02000_□□	25	1,5	16,8	535	300/500
CV25G250_02000_□□	25	2,5	20,9	860	300/500
CV34G075_02000_□□	34	0,75	16,5	438	300/500
CV34G100_02000_□□	34	1	17,7	537	300/500
CV34G150_02000_□□	34	1,5	20	738	300/500
CV42G150_02000_□□	42	1,5	21,6	891	300/500
CV50G150_02000_□□	50	1,5	23,8	1068	300/500

Composizione del codice - Code composition

CV □□□ □□□ _02000_ □□		Colore Color	Inserire To be inserted
Numero conduttori Number of conductors	Inserire To be inserted	Grigio - Gray	GR
2	02X		
3, ..., 37	03G, ..., 37G		
Sezione Size	Inserire To be inserted		
0,14 mm ² , ..., 6,00 mm ²	014, ..., 600		
10,0 mm ² , ..., 25,0 mm ²	B10, ..., B25		

**SERIES
200S**

Cavi multipolari "Flextek-PUR" antiolio ad alte prestazioni "Flextek-PUR" oil-resistant high performing cables



Posa fissa, schermati - Fixed application, shielded



Impiego - Use

Sono cavi ad alte prestazioni meccaniche resistenti agli olii e alla fiamma e progettati per impiego fisso a bordo macchina o per impieghi mobili occasionali e non ciclici. Vengono normalmente utilizzati per l'equipaggiamento di apparecchiature destinate al mercato Europeo (CE). L'eccellente resistenza all'abrasione ne permette l'utilizzo in collegamenti statici senza particolari protezioni e senza che ne vengano compromesse le qualità elettriche e meccaniche originali. Sono idonei alla posa in ambienti industriali interni ed esterni anche in presenza di umidità e raggi UV. La marcatura metrica stampigliata sulla guaina del cavo ne favorisce la lavorazione e l'installazione.

These are oil resistant and flame resistant high performing machine tool wire cables planned also for occasional non-cyclical mobile uses. They are normally used for equipment meant for the European market (EC). Their excellent abrasion resistance permit their use in static connections without particular protections and without compromising the original electrical and mechanical properties. They are suitable for indoor and outdoor installations in dry and damp environments also exposed to UV rays. The metric marked on the jacket allows an easier processing and installation of the cable.

Informazione. Si effettua, su richiesta, un servizio aggiuntivo di taglio a misura.
Information. An additional cut-to-length service is carried out on request.

Dati tecnici - Technical data

Caratteristica - Characteristics	Valore/proprietà - Value/property
Conduttore <i>Conductor</i>	Trefolo in rame, classe 5 - CEI EN 60228 <i>Copper strand, class 5 - CEI EN 60228</i>
Isolamento <i>Insulation</i>	Mescola di PVC <i>PVC compound</i>
Distinzione conduttori <i>Conductor distinction</i>	Neri numerati + giallo/verde (a partire dai 3 conduttori) <i>Black numbered + yellow/green (beginning from 3 conductors)</i>
Schermatura <i>Shield</i>	Treccia di rame stagnato, ricopertura nom. 85% <i>Tinned copper braid, nom. coverage 85%</i>
Guaina <i>Jacket</i>	Mescola di PUR antiolio e antifiamma, colore grigio RAL 7001. Marcatura metrica. <i>Oil and flame-resistant PUR compound, RAL 7001 gray color. Metric marking.</i>
Temperatura di esercizio <i>Temperature range</i>	-40°C, +80°C (posa fissa); -5°C, +70°C (mobile) <i>-40°C, +80°C (fixed); -5°C, +70°C (not fixed)</i>
Tensione nominale <i>Voltage rating</i>	300/500 V
Tensione di prova <i>Test voltage</i>	3000 V
Raggio di curvatura <i>Bending radius</i>	6 volte diametro esterno del cavo (posa fissa); 20 volte diametro esterno del cavo (mobile) <i>6 x cable outer diameter (fixed); 20 x cable outer diameter (mobile)</i>
Riferimenti normativi costruttivi <i>Standards of construction</i>	Flame res.: IEC 60332-1-2, DIN VDE 0472 UV res.: UNI EN ISO 4892-3 (grigio/gray), UNI EN ISO 4892-2 (nero/black) Other: CEI 20-11, VDE 0207, CEI EN 60228, VDE 0295, LVD 2006/95/EC (Low Voltage Directive)

Marcatura - Marking

TEKIMA 0200S "FLEXTEK-PUR" - CE 12G2,5 mm² 300/500 V - IEC 60332-1-2 - (prod.reference) = (metric) =

Codifiche e dimensioni - Coding and dimensions

Codice <i>Code</i>	Numero <i>Number</i>	Sezione <i>Size [mm²]</i>	Diametro <i>Diameter [mm]</i>	Peso <i>Weight [kg/km]</i>	Tensione <i>Voltage [V]</i>
CV02X050_0200S_□□	2	0,5	5,5	40	300/500
CV02X075_0200S_□□	2	0,75	5,9	52	300/500
CV02X100_0200S_□□	2	1	6,3	58	300/500
CV02X150_0200S_□□	2	1,5	6,9	72	300/500
CV02X250_0200S_□□	2	2,5	8,3	106	300/500
CV03G050_0200S_□□	3	0,5	5,8	47	300/500
CV03G075_0200S_□□	3	0,75	6,3	61	300/500
CV03G100_0200S_□□	3	1	6,7	70	300/500
CV03G150_0200S_□□	3	1,5	7,4	93	300/500
CV03G250_0200S_□□	3	2,5	8,9	137	300/500
CV04G050_0200S_□□	4	0,5	6,3	61	300/500
CV04G075_0200S_□□	4	0,75	6,9	74	300/500
CV04G100_0200S_□□	4	1	7,3	90	300/500

Codice Code	Numero Number	Sezione Size [mm ²]	Diametro Diameter [mm]	Peso Weight [kg/km]	Tensione Voltage [V]
CV04G150_0200S_□□	4	1,5	8,1	115	300/500
CV04G250_0200S_□□	4	2,5	9,8	176	300/500
CV04G400_0200S_□□	4	4	11,5	257	300/500
CV04G600_0200S_□□	4	6	13,8	378	300/500
CV04GB10_0200S_□□	4	10	17,1	591	300/500
CV04GB16_0200S_□□	4	16	19,9	860	300/500
CV05G050_0200S_□□	5	0,5	6,9	72	300/500
CV05G075_0200S_□□	5	0,75	7,5	93	300/500
CV05G100_0200S_□□	5	1	8	108	300/500
CV05G150_0200S_□□	5	1,5	8,9	143	300/500
CV05G250_0200S_□□	5	2,5	10,8	212	300/500
CV05G400_0200S_□□	5	4	12,8	313	300/500
CV05G600_0200S_□□	5	6	15,3	462	300/500
CV05GB10_0200S_□□	5	10	19,1	723	300/500
CV05GB16_0200S_□□	5	16	22,2	1053	300/500
CV07G050_0200S_□□	7	0,5	7,5	92	300/500
CV07G075_0200S_□□	7	0,75	8,2	113	300/500
CV07G100_0200S_□□	7	1	8,7	138	300/500
CV07G150_0200S_□□	7	1,5	9,8	183	300/500
CV07G250_0200S_□□	7	2,5	11,8	273	300/500
CV12G050_0200S_□□	12	0,5	9,7	148	300/500
CV12G075_0200S_□□	12	0,75	10,7	183	300/500
CV12G100_0200S_□□	12	1	11,4	221	300/500
CV12G150_0200S_□□	12	1,5	12,8	294	300/500
CV18G050_0200S_□□	18	0,5	11,5	207	300/500
CV18G075_0200S_□□	18	0,75	12,6	266	300/500
CV18G100_0200S_□□	18	1	13,7	333	300/500
CV18G150_0200S_□□	18	1,5	15,4	446	300/500
CV25G050_0200S_□□	25	0,5	13,4	285	300/500
CV25G075_0200S_□□	25	0,75	14,8	367	300/500
CV25G100_0200S_□□	25	1	15,8	435	300/500
CV25G150_0200S_□□	25	1,5	17,8	593	300/500
CV34G100_0200S_□□	34	1	18,5	588	300/500
CV42G100_0200S_□□	42	1	20	715	300/500
CV50G100_0200S_□□	50	1	21,8	823	300/500
CV61G100_0200S_□□	61	1	23,3	979	300/500

Composizione del codice - Code composition

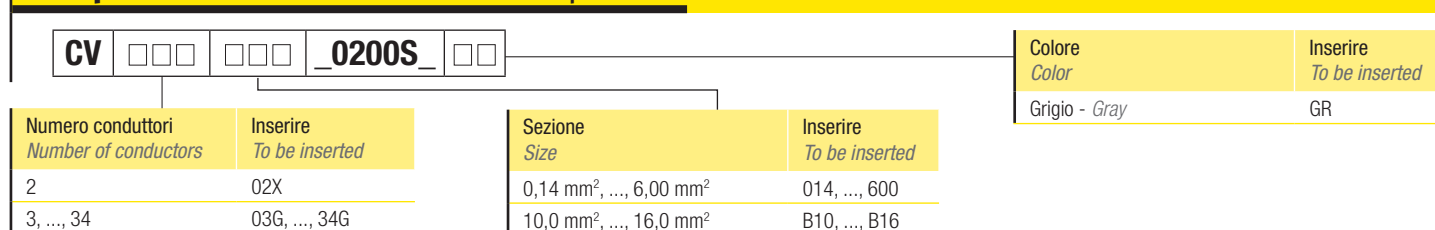

SERIES
345

Cavi multipolari multinorma antiolio

Multi-norm oil-resistant cables

Posa fissa, non schermati - Fixed application, unshielded



cRUUS

RoHS

CE UK CA

Impiego - Use

Sono cavi progettati per impiego fisso a bordo macchina o per impieghi mobili occasionali e non ciclici anche in catena portacavi fino a 5 metri e per formazioni da 0.5 mm² fino a 2.5 mm² con un massimo di 6 conduttori privo di sollecitazioni a trazione. Vengono normalmente utilizzati per l'equipaggiamento di apparecchiature destinate sia al mercato Europeo (CE) che ai mercati nord americani e canadesi. La loro buona resistenza all'olio ed all'abrasione ne permette l'utilizzo in collegamenti statici senza particolari protezioni e senza che ne vengano compromesse le qualità elettriche e meccaniche originali. L'ottima resistenza alla fiamma li rende inoltre idonei alla posa in qualsiasi ambiente industriale. La marcatura metrica stampigliata sulla guaina del cavo ne favorisce la lavorazione e l'installazione.

They are cables designed for fixed applications or for occasional and non-cyclic mobile use even in drag-chains up to 5 meters and for sizes from 0.5 mm² to 2.5 mm² with a maximum of 6 conductors without tensile stress. They are normally used for equipments meant for the European (EC), North American and Canadian markets. Their good oil and abrasion resistance permit their use in static connections without particular protections and without compromising the original electrical and mechanical properties. The good flame resistance makes them suitable for the installation in any industrial environment. The metric marked on the jacket allows an easier processing and installation of the cable.

Informazione. Si effettua, su richiesta, un servizio aggiuntivo di taglio a misura certificato UL ("Processed Wire").

Information. An additional UL certified cut-to-length service is carried out on request ("Processed Wire").

Marcatura - Marking

TEKIMA 03450 - CE 4G1,5 mm² 90°C 450/750 V IEC 60332-1-2 IEC 60332-3-24 - c(UR)us AWM Style 21179 E314444 4x16 AWG 90°C 1000 V VW-1 AWM I/II A/B 90°C 1000 V FT1 - (prod.reference) = (metric) =

Dati tecnici - Technical data

Caratteristica - Characteristics	Valore/proprietà - Value/property
Conduttore <i>Conductor</i>	Trefolo flessibile in rame, classe 5 <i>Flexible copper strand, class 5</i>
Isolamento <i>Insulation</i>	Mescola di PVC <i>PVC compound</i>
Distinzione conduttori <i>Conductor distinction</i>	Neri numerati + giallo/verde (a partire dai 3 conduttori) <i>Black numbered + yellow/green (beginning from 3 conductors)</i>
Riempitivi <i>Fillers</i>	Eventuali riempitivi centrali o laterali <i>Central or side fillers, if any</i>
Guaina <i>Jacket</i>	Mescola di PVC antiolio, colore grigio RAL 7001. Marcatura metrica. <i>PVC compound, oil-resistant, RAL 7001 gray color. Metric marking.</i>
Temperatura di esercizio <i>Temperature range</i>	-40°C (posa fissa); -5°C (posa mobile non ciclica), +90°C <i>-40°C (fixed); -5°C (not fixed), +90°C</i>
Tensione nominale <i>Voltage rating</i>	Posa fissa/Fixed: 1000 V (UL-CSA), 450/750 V (IEC) Posa mobile non ciclica/Not fixed: 1000 V (UL-CSA), 300/500 V (IEC)
Tensione di prova <i>Test voltage</i>	6000 V
Raggio di curvatura <i>Bending radius</i>	4 volte diametro esterno del cavo (posa fissa) 15 volte diametro esterno del cavo (posa mobile non ciclica) <i>4 x cable outer diameter (fixed) 15 x cable outer diameter (not fixed)</i>
Riferimenti normativi costruttivi <i>Standards of construction</i>	Flame res.: IEC 60332-1-2, IEC 60332-3-24, UL VW-1, CSA FT1 UV res.: UNI EN ISO 4892-3 (grigio/gray) Other: CEI EN 60228, VDE 0295, UL 1581, UL 758, CSA AWM I/II A/B, cURus AWM Style 21179, 2014/35/EC (Low Voltage Directive)
Riferimenti normativi d'impiego <i>Standards of use</i>	ANSI/NFPA 79, UL 508a, CSA C22.1 (CE Code), CSA C22.2 No.286, Style 21179

Codifiche e dimensioni - Coding and dimensions

Codice <i>Code</i>	Numero di conduttori <i>Number of conductors</i>	Sezione Size [mm ²]	Sezione Size [AWG]	Diametro Diameter [mm]	Peso Weight [kg/km]
CV02X034_03450_GR	2	0,34	22	4,6	30
CV02X050_03450_GR	2	0,5	21	5,0	36
CV02X075_03450_GR	2	0,75	19	5,4	45
CV02X100_03450_GR	2	1	18	5,7	52
CV02X150_03450_GR	2	1,5	16	6,3	68
CV02X250_03450_GR	2	2,5	14	7,5	101
CV02X400_03450_GR	2	4	12	8,8	147
CV02X600_03450_GR	2	6	10	10,4	211
CV03G034_03450_GR	3	0,34	22	4,9	36
CV03G050_03450_GR	3	0,5	21	5,3	43
CV03G075_03450_GR	3	0,75	19	5,7	54
CV03G075_03450_GR	3	0,75	19	5,7	54
CV03G100_03450_GR	3	1	18	6,1	64
CV03G150_03450_GR	3	1,5	16	6,7	84
CV03G250_03450_GR	3	2,5	14	8,0	128

Codice Code	Numero di conduttori Number of conductors	Sezione Size [mm ²]	Sezione Size [AWG]	Diametro Diameter [mm]	Peso Weight [kg/km]
CV03G400_03450_GR	3	4	12	9,3	186
CV03G600_03450_GR	3	6	10	11,1	271
CV03GB10_03450_GR	3	10	8	14,5	456
CV03GB16_03450_GR	3	16	6	16,8	668
CV03GB25_03450_GR	3	25	4	21,6	1073
CV03GB35_03450_GR	3	35	2	24,2	1420
CV03GB50_03450_GR	3	50	1	29,6	2074
CV04G034_03450_GR	4	0,34	22	5,3	43
CV04G050_03450_GR	4	0,5	21	5,7	52
CV04X050_03450_GR	4	0,5	21	5,7	52
CV04G075_03450_GR	4	0,75	19	6,2	66
CV04G100_03450_GR	4	1	18	6,6	79
CV04X100_03450_GR	4	1	18	6,6	79
CV04G150_03450_GR	4	1,5	16	7,3	105
CV04G250_03450_GR	4	2,5	14	8,7	159
CV04G400_03450_GR	4	4	12	10,5	241
CV04G600_03450_GR	4	6	10	12,4	348
CV04GB10_03450_GR	4	10	8	15,9	576
CV04GB16_03450_GR	4	16	6	18,7	859
CV04GB25_03450_GR	4	25	4	23,8	1365
CV04GB35_03450_GR	4	35	2	26,7	1813
CV04GB50_03450_GR	4	50	1	32,6	2641
CV05G034_03450_GR	5	0,34	22	5,8	52
CV05G050_03450_GR	5	0,5	21	6,3	64
CV05G075_03450_GR	5	0,75	19	6,8	80
CV05G100_03450_GR	5	1	18	7,2	95
CV05G150_03450_GR	5	1,5	16	8,0	128
CV05G250_03450_GR	5	2,5	14	9,6	196
CV05G400_03450_GR	5	4	12	11,5	295
CV05G600_03450_GR	5	6	10	13,7	430
CV05GB10_03450_GR	5	10	8	17,9	725
CV05GB16_03450_GR	5	16	6	21,4	1099
CV05GB25_03450_GR	5	25	4	26,4	1693
CV05GB35_03450_GR	5	35	2	30,6	2320
CV05GB50_03450_GR	5	50	1	36,2	3280
CV05GB70_03450_GR	5	70	2/0	37,6	4173
CV06G050_03450_GR	6	0,5	21	6,8	75
CV06G075_03450_GR	6	0,75	19	7,4	95
CV06G100_03450_GR	6	1	18	7,8	113
CV06G150_03450_GR	6	1,5	16	8,7	152
CV07G034_03450_GR	7	0,34	22	6,3	64
CV07G050_03450_GR	7	0,5	21	6,8	78
CV07G075_03450_GR	7	0,75	19	7,4	100
CV07G100_03450_GR	7	1	18	7,8	120
CV07G150_03450_GR	7	1,5	16	8,7	162
CV07G250_03450_GR	7	2,5	14	10,7	257
CV07G400_03450_GR	7	4	12	12,8	388
CV07G600_03450_GR	7	6	10	15,3	568
CV07GB10_03450_GR	7	10	8	19,8	949
CV10G034_03450_GR	10	0,34	22	7,8	97
CV10G050_03450_GR	10	0,5	21	8,4	117
CV10G075_03450_GR	10	0,75	19	9,2	151
CV10G100_03450_GR	10	1	18	10,0	186
CV10G150_03450_GR	10	1,5	16	11,2	252
CV12G034_03450_GR	12	0,34	22	8,0	105
CV12G050_03450_GR	12	0,5	21	8,7	130
CV12X050_03450_GR	12	0,5	21	8,7	130
CV12G075_03450_GR	12	0,75	19	9,5	168
CV12G100_03450_GR	12	1	18	10,3	207

Cavi multipolari per posa fissa - Cables for fixed applications

Codice Code	Numero di conduttori Number of conductors	Sezione Size [mm ²]	Sezione Size [AWG]	Diametro Diameter [mm]	Peso Weight [kg/km]
CV12G150_03450_GR	12	1,5	16	11,5	281
CV12G250_03450_GR	12	2,5	14	14,4	454
CV16G050_03450_GR	16	0,5	21	9,6	163
CV16G075_03450_GR	16	0,75	19	10,7	217
CV16G100_03450_GR	16	1	18	11,4	263
CV16G150_03450_GR	16	1,5	16	13,0	366
CV18G034_03450_GR	18	0,34	22	9,5	151
CV18G050_03450_GR	18	0,5	21	10,4	189
CV18G075_03450_GR	18	0,75	19	11,4	245
CV18G100_03450_GR	18	1	18	12,3	301
CV18G150_03450_GR	18	1,5	16	13,8	413
CV18G250_03450_GR	18	2,5	14	17,1	659
CV20G050_03450_GR	20	0,5	21	11,0	211
CV20G075_03450_GR	20	0,75	19	12,2	278
CV20G100_03450_GR	20	1	18	13,0	336
CV20G150_03450_GR	20	1,5	16	14,8	467
CV25G034_03450_GR	25	0,34	22	11,0	204
CV25G050_03450_GR	25	0,5	21	12,1	258
CV25G075_03450_GR	25	0,75	19	13,3	337
CV25G100_03450_GR	25	1	18	14,3	412
CV25G150_03450_GR	25	1,5	16	16,0	563
CV25G250_03450_GR	25	2,5	14	19,9	904
CV27G050_03450_GR	27	0,5	21	12,8	285
CV27G075_03450_GR	27	0,75	19	14,0	369
CV27G100_03450_GR	27	1	18	15,1	453
CV27G150_03450_GR	27	1,5	16	17,2	631
CV32G050_03450_GR	32	0,5	21	13,3	318
CV32G075_03450_GR	32	0,75	19	14,8	422
CV32G100_03450_GR	32	1	18	15,8	513
CV32G150_03450_GR	32	1,5	16	17,9	712
CV34G034_03450_GR	34	0,34	22	12,8	277
CV34G050_03450_GR	34	0,5	21	14,3	357
CV34G075_03450_GR	34	0,75	19	15,7	465
CV34G100_03450_GR	34	1	18	16,9	569
CV34G150_03450_GR	34	1,5	16	19,2	790
CV37G050_03450_GR	37	0,5	21	14,3	367
CV37G075_03450_GR	37	0,75	19	15,7	480
CV37G100_03450_GR	37	1	18	16,9	589
CV37G150_03450_GR	37	1,5	16	19,2	821
CV41G050_03450_GR	41	0,5	21	15,3	416
CV41G075_03450_GR	41	0,75	19	17,0	551
CV41G100_03450_GR	41	1	18	18,2	671
CV41G150_03450_GR	41	1,5	16	21,2	958
CV42G100_03450_GR	42	1	18	18,2	683
CV50G050_03450_GR	50	0,5	21	16,8	503
CV50G075_03450_GR	50	0,75	19	18,4	655
CV50G100_03450_GR	50	1	18	19,9	808
CV50G150_03450_GR	50	1,5	16	23,0	1146

Composizione del codice - Code composition

CV	□□□□	□□□□	_03450_	□□	Colore Color	Inserire To be inserted	
Numero conduttori Number of conductors	Inserire To be inserted		Sezione Size	Inserire To be inserted		Grigio - Gray	GR
2	02X		0,34 mm ² , ..., 6,00 mm ²	034, ..., 600			
3, ..., 50	03G, ..., 50G		10 mm ² , ..., 70 mm ²	B10, ..., B70			

**SERIES
345S**

Cavi multipolari multinorma antiolio

Multi-norm oil-resistant cables

Posa fissa, schermati - Fixed application, shielded



Impiego - Use

Sono cavi schermati progettati per impiego fisso a bordo macchina o per impieghi mobili occasionali e non ciclici. Vengono normalmente utilizzati per l'equipaggiamento di apparecchiature destinate sia al mercato Europeo (CE) che ai mercati nord americani e canadesi. La loro buona resistenza all'olio ed all'abrasione ne permette l'utilizzo in collegamenti statici senza particolari protezioni e senza che ne vengano compromesse le qualità elettriche e meccaniche originali. L'ottima resistenza alla fiamma li rende inoltre idonei alla posa in qualsiasi ambiente industriale. La marcatura metrica stampigliata sulla guaina del cavo ne favorisce la lavorazione e l'installazione.

These are machine tool wire cables planned also for occasional non-cyclical mobile uses. They are normally used for equipments meant for the European (EC), North American and Canadian markets. Their good oil and abrasion resistance permit their use in static connections without particular protections and without compromising the original electrical and mechanical properties. The good flame resistance makes them suitable for the installation in any industrial environment. The metric marked on the jacket allows an easier processing and installation of the cable.

Informazione. Si effettua, su richiesta, un servizio aggiuntivo di taglio a misura certificato UL ("Processed Wire").
Information. An additional UL certified cut-to-length service is carried out on request ("Processed Wire").

Dati tecnici - Technical data

Caratteristica - Characteristics	Valore/proprietà - Value/property
Conduttore <i>Conductor</i>	Trefolo flessibile in rame, classe 5 <i>Flexible copper strand, class 5</i>
Isolamento <i>Insulation</i>	Mescola di PVC <i>PVC compound</i>
Distinzione conduttori <i>Conductor distinction</i>	Neri numerati + giallo/verde (a partire dai 3 conduttori) <i>Black numbered + yellow/green (beginning from 3 conductors)</i>
Riempitivi <i>Fillers</i>	Eventuali riempitivi centrali o laterali <i>Central or side fillers, if any</i>
Schermatura <i>Shield</i>	Treccia di rame stagnato, ricopertura nom. 85% <i>Tinned copper braid, nom. coverage 85%</i>
Guaina <i>Jacket</i>	Mescola di PVC antiolio, colore grigio RAL 7001. Marcatura metrica. <i>PVC compound, oil-resistant, RAL 7001 gray color. Metric marking.</i>
Temperatura di esercizio <i>Temperature range</i>	-40°C (posa fissa); -5°C (posa mobile non ciclica), +90°C <i>-40°C (fixed); -5°C (not fixed), +90°C</i>
Tensione nominale <i>Voltage rating</i>	Posa fissa/Fixed: 1000 V (UL-CSA), 450/750 V (IEC) Posa mobile non ciclica/Not fixed: 1000 V (UL-CSA), 300/500 V (IEC)
Tensione di prova <i>Test voltage</i>	6000 V
Raggio di curvatura <i>Bending radius</i>	6 volte diametro esterno del cavo (posa fissa) 20 volte diametro esterno del cavo (posa mobile non ciclica) <i>6 x cable outer diameter (fixed) 20 x cable outer diameter (not fixed)</i>
Riferimenti normativi costruttivi <i>Standards of construction</i>	Flame res.: IEC 60332-1-2, IEC 60332-3-24, UL VW-1, CSA FT1 UV res.: UNI EN ISO 4892-3 (grigio/gray) Other: CEI EN 60228, VDE 0295, UL 1581, UL 758, CSA AWM I/II A/B, cURus AWM Style 21179, 2014/35/EC (Low Voltage Directive)
Riferimenti normativi d'impiego <i>Standards of use</i>	ANSI/NFPA 79, UL 508a, CSA C22.1 (CE Code), CSA C22.2 No.286, Style 21179

Marcatura - Marking

TEKIMA 0345S – CE 4G1,5 mm² 90°C 450/750 V IEC 60332-1-2 IEC 60332-3-24 – c(UR)us AWM Style 21179 E314444 4x16 AWG 90°C 1000 V VW-1 AWM I/II A/B 90°C 1000 V FT1 – (prod.reference) = (metric) =

Codifiche e dimensioni - Coding and dimensions

Codice <i>Code</i>	Numero di conduttori <i>Number of conductors</i>	Sezione Size [mm ²]	Sezione Size [AWG]	Diametro Diameter [mm]	Peso Weight [kg/km]
CV02X034_0345S_GR	2	0,34	22	5,2	42
CV02X050_0345S_GR	2	0,5	21	5,6	47
CV02X075_0345S_GR	2	0,75	19	6,0	54
CV02X100_0345S_GR	2	1	18	6,3	65
CV02X150_0345S_GR	2	1,5	16	6,9	79
CV02X250_0345S_GR	2	2,5	14	8,1	111

Cavi multipolari per posa fissa - Cables for fixed applications

Codice Code	Numero di conduttori Number of conductors	Sezione Size [mm ²]	Sezione Size [AWG]	Diametro Diameter [mm]	Peso Weight [kg/km]
CV02X400_0345S_GR	2	4	12	9,4	158
CV02X600_0345S_GR	2	6	10	11,0	217
CV03G034_0345S_GR	3	0,34	22	5,5	48
CV03G050_0345S_GR	3	0,5	21	5,9	54
CV03X050_0345S_GR	3	0,5	21	5,9	54
CV03G075_0345S_GR	3	0,75	19	6,3	68
CV03G100_0345S_GR	3	1	18	6,7	77
CV03X100_0345S_GR	3	1	18	6,7	77
CV03G150_0345S_GR	3	1,5	16	7,3	100
CV03X150_0345S_GR	3	1,5	16	7,3	100
CV03G250_0345S_GR	3	2,5	14	8,6	142
CV03G400_0345S_GR	3	4	12	10,1	203
CV03G600_0345S_GR	3	6	10	11,7	282
CV03GB10_0345S_GR	3	10	8	15,3	467
CV03GB16_0345S_GR	3	16	6	17,6	674
CV04G034_0345S_GR	4	0,34	22	5,9	58
CV04G050_0345S_GR	4	0,5	21	6,3	68
CV04X050_0345S_GR	4	0,5	21	6,3	68
CV04G075_0345S_GR	4	0,75	19	6,8	80
CV04X075_0345S_GR	4	0,75	19	6,8	80
CV04G100_0345S_GR	4	1	18	7,2	97
CV04X100_0345S_GR	4	1	18	7,2	97
CV04G150_0345S_GR	4	1,5	16	7,9	121
CV04G250_0345S_GR	4	2,5	14	9,3	179
CV04G400_0345S_GR	4	4	12	11,1	262
CV04G600_0345S_GR	4	6	10	13,2	384
CV04GB10_0345S_GR	4	10	8	16,9	616
CV04GB16_0345S_GR	4	16	6	19,5	890
CV04GB25_0345S_GR	4	25	4	24,6	1380
CV04GB35_0345S_GR	4	35	2	27,7	1823
CV04GB50_0345S_GR	4	50	1	33,6	2645
CV04GB70_0345S_GR	4	70	2/0	38,8	2935
CV05G034_0345S_GR	5	0,34	22	6,4	67
CV05G050_0345S_GR	5	0,5	21	6,9	79
CV05G075_0345S_GR	5	0,75	19	7,4	98
CV05G100_0345S_GR	5	1	18	7,8	113
CV05G150_0345S_GR	5	1,5	16	8,6	147
CV05G250_0345S_GR	5	2,5	14	10,4	219
CV05G400_0345S_GR	5	4	12	12,3	321
CV05G600_0345S_GR	5	6	10	14,7	471
CV05GB10_0345S_GR	5	10	8	18,9	764
CV05GB16_0345S_GR	5	16	6	22,2	1121
CV05GB25_0345S_GR	5	25	4	27,2	1686
CV05GB35_0345S_GR	5	35	2	31,6	2334
CV07G034_0345S_GR	7	0,34	22	6,9	81
CV07G050_0345S_GR	7	0,5	21	7,4	97
CV07G075_0345S_GR	7	0,75	19	8,0	118
CV07G100_0345S_GR	7	1	18	8,4	141
CV07G150_0345S_GR	7	1,5	16	9,3	185
CV07G250_0345S_GR	7	2,5	14	11,3	278
CV07G400_0345S_GR	7	4	12	13,6	422
CV07G600_0345S_GR	7	6	10	16,1	604
CV10G034_0345S_GR	10	0,34	22	8,4	108
CV12G034_0345S_GR	12	0,34	22	8,7	122
CV12G050_0345S_GR	12	0,5	21	9,3	149
CV12G075_0345S_GR	12	0,75	19	10,3	188
CV12G100_0345S_GR	12	1	18	10,9	224
CV12G150_0345S_GR	12	1,5	16	12,3	302
CV12G250_0345S_GR	12	2,5	14	15,2	476

Codice Code	Numero di conduttori Number of conductors	Sezione Size [mm ²]	Sezione Size [AWG]	Diametro Diameter [mm]	Peso Weight [kg/km]
CV18G034_0345S_GR	18	0,34	22	10,1	171
CV18G050_0345S_GR	18	0,5	21	11,0	210
CV18G075_0345S_GR	18	0,75	19	12,2	272
CV18G100_0345S_GR	18	1	18	12,9	320
CV18G150_0345S_GR	18	1,5	16	14,8	454
CV18G250_0345S_GR	18	2,5	14	17,9	693
CV25G034_0345S_GR	25	0,34	22	11,6	222
CV25G050_0345S_GR	25	0,5	21	12,7	273
CV25G075_0345S_GR	25	0,75	19	14,3	374
CV25G100_0345S_GR	25	1	18	15,1	439
CV25G150_0345S_GR	25	1,5	16	17,0	595
CV25G250_0345S_GR	25	2,5	14	21,3	949
CV30G050_0345S_GR	30	0,5	21	13,8	338
CV30G075_0345S_GR	30	0,75	19	15,3	429
CV30G100_0345S_GR	30	1	18	16,2	514
CV30G150_0345S_GR	30	1,5	16	18,3	697
CV34G034_0345S_GR	34	0,34	22	13,8	311
CV34G050_0345S_GR	34	0,5	21	15,1	381
CV34G075_0345S_GR	34	0,75	19	16,7	493
CV34G100_0345S_GR	34	1	18	17,7	590
CV34G150_0345S_GR	34	1,5	16	20,0	798
CV34G250_0345S_GR	34	2,5	14	24,7	1255
CV37G050_0345S_GR	37	0,5	21	15,1	399
CV37G075_0345S_GR	37	0,75	19	16,7	517
CV37G100_0345S_GR	37	1	18	17,7	621
CV37G150_0345S_GR	37	1,5	16	20,0	843
CV41G050_0345S_GR	41	0,5	21	16,1	450
CV41G075_0345S_GR	41	0,75	19	17,8	583
CV41G100_0345S_GR	41	1	18	19,2	709
CV41G150_0345S_GR	41	1,5	16	22,0	979
CV42G050_0345S_GR	42	0,5	21	16,1	457
CV42G075_0345S_GR	42	0,75	19	17,8	593
CV42G100_0345S_GR	42	1	18	19,2	721
CV42G150_0345S_GR	42	1,5	16	22,0	997
CV50G050_0345S_GR	50	0,5	21	17,6	527
CV50G075_0345S_GR	50	0,75	19	19,4	682
CV50G100_0345S_GR	50	1	18	21,3	850
CV50G150_0345S_GR	50	1,5	16	23,8	1146
CV61G050_0345S_GR	61	0,5	21	18,4	608
CV61G075_0345S_GR	61	0,75	19	21,0	831
CV61G100_0345S_GR	61	1	18	22,3	997
CV61G150_0345S_GR	61	1,5	16	24,9	1343

Composizione del codice - Code composition

CV	□□□	□□□	_0345S_	□□	Colore Color	Inserire To be inserted
					Grigio - Gray	GR
Numero conduttori Number of conductors	Inserire To be inserted		Sezione Size	Inserire To be inserted		
2	02X		0,34 mm ² , ..., 6,00 mm ²	034, ..., 600		
3, ..., 61	03G, ..., 61G		10 mm ² , ..., 70 mm ²	B10, ..., B70		

**SERIES
361S**

Cavi VFD 3xG a bassa capacità, AWM

Low capacity VFD 3xG cables, AWM

Posa fissa, schermati - Fixed application, shielded



Impiego - Use

Sono cavi a bassa capacità progettati per servo motori (Variable Frequency Driver) e per impiego fisso o per impieghi mobili occasionali e non ciclici. Vengono normalmente utilizzati dove è alto il rischio di interferenze dovute a inverter, motori, apparecchiature di controllo. Si differenziano rispetto ai cavi tradizionali per le loro peculiarità costruttive, tra le quali il doppio schermo, le mescole di isolamento e le geometrie costruttive. E' proprio grazie a questi ed altri numerosi accorgimenti che questa gamma di cavi è in grado di garantire una bassa capacità operativa, di limitare enormemente i picchi di sovratensione spesso causa di danneggiamenti agli apparati collegati e, non ultimo, una conseguente riduzione delle perdite. Questi cavi sono destinati sia al mercato Europeo (CE) che ai mercati nord americani e canadesi. La marcatura metrica stampigliata sulla guaina del cavo ne favorisce la lavorazione e l'installazione.

These are low capacitance servo motor (Variable Frequency Driver) cables planned for fixed application but also for occasional non-cyclical mobile uses. They are normally used wherever the potential for electromagnetic interference due to drives, frequency converter and motor is high. These cables are different than the traditional ones for their constructive peculiarities, including the double screen, the compounds used for the insulation and the constructive geometry. It is thanks to these and many other factors that this range of cables is able to ensure a low operational capacity, to limit overvoltage peaks which often cause damage to connected equipment and, not least, a consequent reduction of the losses. These cables are produced to meet the requirements of the European (EC), North American and Canadian markets. The metric marked on the jacket allows an easier processing and installation of the cable.

Informazione. Si effettua, su richiesta, un servizio aggiuntivo di taglio a misura certificato UL ("Processed Wire").

Information. An additional UL certified cut-to-length service is carried out on request ("Processed Wire").

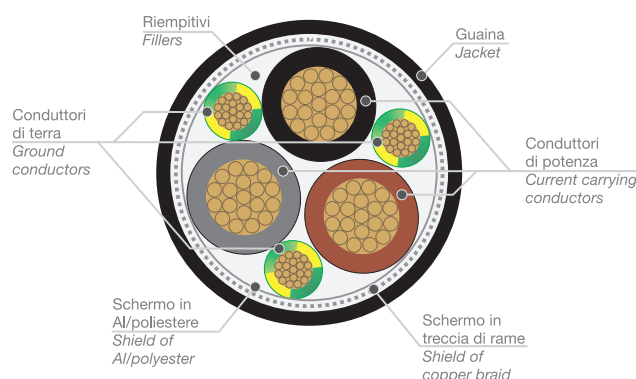

Dati tecnici - Technical data

Caratteristica - Characteristics	Valore/proprietà - Value/property
Conduttore <i>Conductor</i>	Trefolo flessibile in rame, classe 5 <i>Flexible copper strand, class 5</i>
Isolamento <i>Insulation</i>	TKblend®-YP
Distinzione conduttori <i>Conductor distinction</i>	3 conduttori grigio, nero, marrone + 3 conduttori giallo/verde (secondo DIN VDI 0293) <i>3 wires gray, black, brown + 3 wires yellow/green (acc. to DIN VDI 0293)</i>
Riempitivi <i>Fillers</i>	Eventuali riempitivi centrali o laterali <i>Central or side fillers, if any</i>
Schermatura <i>Shield</i>	Lamina di alluminio/poliestere, ricopertura 100% + Treccia di rame stagnato, ricopertura nom. 70% <i>Aluminum/polyester foil, coverage 100% + Tinned copper braid, nom. coverage 70%</i>
Guaina <i>Jacket</i>	Miscela di PVC antiolio, colore nero o grigio RAL 7001 su richiesta. Marcatura metrica. <i>PVC compound, oil-resistant, black or RAL 7001 gray color on request. Metric marking.</i>
Temperatura di esercizio <i>Temperature range</i>	+90°C (IEC), +80°C (UL/CSA) -40°C (posa fissa); -5°C (posa mobile non ciclica) <i>-40°C (fixed); -5°C (not fixed)</i>
Tensione nominale <i>Voltage rating</i>	600 V (UL-CSA), 600/1000V (IEC)
Tensione di prova <i>Test voltage</i>	6000 V
Raggio di curvatura <i>Bending radius</i>	4 volte diametro esterno del cavo (posa fissa) 15 volte diametro esterno del cavo (posa mobile non ciclica) <i>4 x cable outer diameter (fixed) 15 x cable outer diameter (not fixed)</i>
Riferimenti normativi costruttivi <i>Standards of construction</i>	Flame res.: IEC 60332-1-2, IEC 60332-3-24, NBN C30-004 cat. F2, UL VW-1, CSA FT1 I UV res.: UNI EN ISO 4892-3 (grigio/gray), UNI EN ISO 4892-2 (nero/black) I Oil res.: DIN EN 50290-2-22, VDE 0819-102 I Other: CEI EN 60228, DIN VDE 0295, IEC 60228, DIN VDE 0293, UL 758, CSA AWM I/II A/B, cURus AWM Style 2570, Low Voltage, Directive (LVD) 2006/95/EC
Riferimenti normativi d'impiego <i>Standards of use</i>	ANSI/NFPA 79, UL 508a, CSA C22.1 (CE Code), CSA C22.2 No.286, Style 2570

Marcatura - Marking

TEKIMA 0361S – CE VFD (3x2,5+3G0,5) mm² 90°C 600/1000 V IEC 60332-1-2 – c(UR)us E314444 AWM Style 2570 (3x14+3x21) AWG 80°C 1000 V AWM Class I/II A/B – (prod. reference) = (metric) =

Codifiche e dimensioni - Coding and dimensions

Codice <i>Code</i>	N° di conduttori x sezione <i>Num. conductors x size [mm²]</i>	N° di conduttori x sezione <i>Num. conductors x size [AWG/kcmil]</i>	Diametro <i>Diameter [mm]</i>	Peso <i>Weight [kg/km]</i>
CVFM0015_0361S_NE	(3x1,5+3G0,25)	(3x16+3G24)	8,7	117
CVFM0001_0361S_NE	(3x2,5+3G0,5)	(3x14+3G21)	10,1	168

Codice <i>Code</i>	N° di conduttori x sezione <i>Num. conductors x size [mm²]</i>	N° di conduttori x sezione <i>Num. conductors x size [AWG/kcmil]</i>	Diametro <i>Diameter [mm]</i>	Peso <i>Weight [kg/km]</i>
CVFM0002_0361S_NE	(3x4+3G0,75)	(3x12+3G19)	11,3	228
CVFM0003_0361S_NE	(3x6+3G1)	(3x10+3G18)	12,4	302
CVFM0004_0361S_NE	(3x10+3G1,5)	(3x8+3G16)	15,2	470
CVFM0005_0361S_NE	(3x16+3G2,5)	(3x8+3G14)	18,3	719
CVFM0006_0361S_NE	(3x25+3G4)	(3x4+3G12)	22,5	1089
CVFM0007_0361S_NE	(3x35+3G6)	(3x2+3G10)	25,5	1467
CVFM0008_0361S_NE	(3x50+3G10)	(3x1+3G8)	30,8	2130
CVFM0009_0361S_NE	(3x70+3G10)	(3x2/0+3G8)	36,1	2828
CVFM0010_0361S_NE	(3x95+3G16)	(3x3/0+3G6)	41,0	3844
CVFM0011_0361S_NE	(3x120+3G16)	(3x4/0+3G6)	43,8	4556
CVFM0012_0361S_NE	(3x150+3G25)	(3x250+3G4)	48,7	5811
CVFM0013_0361S_NE	(3x185+3G35)	(3x350+3G2)	54,2	7226
CVFM0014_0361S_NE	(3x240+3G50)	(3x450+3G1)	61,4	9478

Composizione del codice - Code composition

CVFM □ □ □ □ _0361S_ □ □	Colore <i>Color</i>	Inserire <i>To be inserted</i>
Formazione <i>Construction</i>	Grigio <i>Gray</i>	GR
Codice identificativo della particolare formazione del cavo. <i>Identifier code of the special cable construction.</i>	Nero <i>Black</i>	NE

**SERIES
361S**

Cavi VFD 1xG a bassa capacità, AWM

Low capacity VFD 1xG cables, AWM

Posa fissa, schermati - Fixed application, shielded



Impiego - Use

Sono cavi a bassa capacità progettati per servo motori (Variable Frequency Driver) e per impiego fisso o per impieghi mobili occasionali e non ciclici. Vengono normalmente utilizzati dove è alto il rischio di interferenze dovute a inverter, motori, apparecchiature di controllo. Si differenziano rispetto ai cavi tradizionali per le loro peculiarità costruttive, tra le quali il doppio schermo, le mescole di isolamento e le geometrie costruttive. E' proprio grazie a questi ed altri numerosi accorgimenti che questa gamma di cavi è in grado di garantire una bassa capacità operativa, di limitare enormemente i picchi di sovratensione spesso causa di danneggiamenti agli apparati collegati e, non ultimo, una conseguente riduzione delle perdite. Questi cavi sono destinati sia al mercato Europeo (CE) che ai mercati nord americani e canadesi. La marcatura metrica stampigliata sulla guaina del cavo ne favorisce la lavorazione e l'installazione.

These are low capacitance servo motor (Variable Frequency Driver) cables planned for fixed application but also for occasional non-cyclical mobile uses. They are normally used wherever the potential for electromagnetic interference due to drives, frequency converter and motor is high. These cables are different than the traditional ones for their constructive peculiarities, including the double screen, the compounds used for the insulation and the constructive geometry. It is thanks to these and many other factors that this range of cables is able to ensure a low operational capacity, to limit overvoltage peaks which often cause damage to connected equipment and, not least, a consequent reduction of the losses. These cables are produced to meet the requirements of the European (EC), North American and Canadian markets. The metric marked on the jacket allows an easier processing and installation of the cable.

Informazione. Si effettua, su richiesta, un servizio aggiuntivo di taglio a misura certificato UL ("Processed Wire").

Information. An additional UL certified cut-to-length service is carried out on request ("Processed Wire").

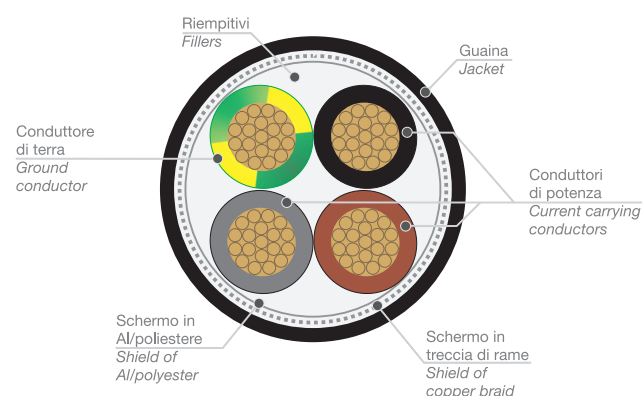

Dati tecnici - Technical data

Caratteristica - Characteristics	Valore/proprietà - Value/property
Conduttore <i>Conductor</i>	Trefolo flessibile in rame, classe 5 <i>Flexible copper strand, class 5</i>
Isolamento <i>Insulation</i>	TKblend®-YP
Distinzione conduttori <i>Conductor distinction</i>	Conduttori grigio, nero, marrone, giallo/verde (secondo DIN VDI 0293) <i>Wires gray, black, brown, wires yellow/green (acc. to DIN VDI 0293)</i>
Riempitivi <i>Fillers</i>	Eventuali riempitivi centrali o laterali <i>Central or side fillers, if any</i>
Schermatura <i>Shield</i>	Lamina di alluminio/poliestere, ricopertura 100% + Treccia di rame stagnato, ricopertura nom. 70% <i>Aluminum/polyester foil, coverage 100% + Tinned copper braid, nom. coverage 70%</i>
Guaina <i>Jacket</i>	Miscela di PVC antiolio, colore nero o grigio RAL 7001 su richiesta. Marcatura metrica. <i>PVC compound, oil-resistant, black or RAL 7001 gray color on request. Metric marking.</i>
Temperatura di esercizio <i>Temperature range</i>	+90°C (IEC), +80°C (UL/CSA) -40°C (posa fissa); -5°C (posa mobile non ciclica) <i>-40°C (fixed); -5°C (not fixed)</i>
Tensione nominale <i>Voltage rating</i>	600 V (UL-CSA), 600/1000V (IEC)
Tensione di prova <i>Test voltage</i>	6000 V
Raggio di curvatura <i>Bending radius</i>	4 volte diametro esterno del cavo (posa fissa) 15 volte diametro esterno del cavo (posa mobile non ciclica) <i>4 x cable outer diameter (fixed) 15 x cable outer diameter (not fixed)</i>
Riferimenti normativi costruttivi <i>Standards of construction</i>	Flame res.: IEC 60332-1-2, IEC 60332-3-24, NBN C30-004 cat. F2, UL VW-1, CSA FT1 I UV res.: UNI EN ISO 4892-3 (grigio/gray), UNI EN ISO 4892-2 (nero/black) I Oil res.: DIN EN 50290-2-22, VDE 0819-102 I Other: CEI EN 60228, DIN VDE 0295, IEC 60228, DIN VDE 0293, UL 758, CSA AWM I/II A/B, cURus AWM Style 2570, Low Voltage, Directive (LVD) 2006/95/EC
Riferimenti normativi d'impiego <i>Standards of use</i>	ANSI/NFPA 79, UL 508a, CSA C22.1 (CE Code), CSA C22.2 No.286, Style 2570

Marcatura - Marking

TEKIMA 0361S – CE VFD (4G1,5) mm² 90°C 600/1000 V IEC 60332-1-2 – c(UR)us E314444 AWM Style 2570 (4x16) AWG 80°C 1000 V AWM Class I/II A/B – (prod. reference) = (metric) =

Codifiche e dimensioni - Coding and dimensions

Codice <i>Code</i>	Numero di conduttori <i>Number of conductors</i>	Sezione <i>Size [mm²]</i>	Sezione <i>Size [AWG]</i>	Diametro <i>Diameter [mm]</i>	Peso <i>Weight [kg/km]</i>
CV04G150_0361S_□□	4	1,5	16 AWG	8,8	112
CV04G250_0361S_□□	4	2,5	14	10,1	164

Codice <i>Code</i>	Numero di conduttori <i>Number of conductors</i>	Sezione <i>Size [mm²]</i>	Sezione <i>Size [AWG]</i>	Diametro <i>Diameter [mm]</i>	Peso <i>Weight [kg/km]</i>
CV04G400_0361S_□□	4	4	12	11,7	232
CV04G600_0361S_□□	4	6	10	13,5	327
CV04GB10_0361S_□□	4	10	8	16,5	523
CV04GB16_0361S_□□	4	16	6	20,0	793
CV04GB25_0361S_□□	4	25	4	24,5	1211
CV04GB35_0361S_□□	4	35	2	27,9	1636
CV04GB50_0361S_□□	4	50	1	33,9	2365
CV04GB70_0361S_□□	4	70	2/0	39,7	3241
CV04GB95_0361S_□□	4	95	3/0	44,8	4308
CV04GL12_0361S_□□	4	120	4/0	47,8	5229
CV04GL15_0361S_□□	4	150	250 kcmil	53,3	6531
CV04GL18_0361S_□□	4	185	350	59,3	7998
CV04GL24_0361S_□□	4	240	450	68,0	10399

Composizione del codice - Code composition

CV		□□□□	□□□□	_0361S_	□□
Numero conduttori <i>Number of conductors</i>	Inserire <i>To be inserted</i>	Sezione <i>Size</i>		Inserire <i>To be inserted</i>	
4	04X	1,5 mm ² , ..., 6,00 mm ²		150, ..., 600	
		10,0 mm ² , ..., 95,0 mm ²		B10, ..., B95	
		120 mm ² , ..., 240 mm ²		L12, ..., L24	
		Colore <i>Color</i>		Inserire <i>To be inserted</i>	
		Grigio <i>Gray</i>		GR	
		Nero <i>Black</i>		NE	

**SERIES
365S**

Cavi VFD 3xG a bassa capacità, TC-ER/CIC/MTW/WTTC, Dir Bur, Sun Res

Low capacity VFD 3xG cables, TC-ER/CIC/MTW/WTTC, Dir Bur, Sun Res

Posa fissa, schermati - Fixed application, shielded



Impiego - Use

Sono cavi oil resistant UL Listed a bassa capacità progettati per servo motori (Variable Frequency Drive) e per impiego fisso o per impieghi mobili occasionali e non ciclici. Vengono utilizzati dove è alto il rischio di interferenze dovute a inverter, motori, apparecchiature di controllo. Si differenziano rispetto ai cavi tradizionali per le loro peculiarità costruttive, tra le quali il doppio schermo, le mescole di isolamento e le geometrie costruttive. Questa gamma di cavi è in grado di garantire una bassa capacità operativa, di limitare enormemente i picchi di sovratensione spesso causa di danneggiamenti agli apparati collegati e, non ultimo, una conseguente riduzione delle perdite. Sono cavi Type TC-ER (Exposed Run) adatti agli usi specificati dall'ANSI/NFPA 79 e dagli articoli 336, 392, 501 del ANSI/NFPA 70 "National Electrical Code" (NEC) e idonei all'impiego in Class I, Division 2, Hazardous Locations. Sono certificati Flexible Motor Supply Cable per azionamenti a velocità variabile e Wind Turbine Tray Cable (WTTC) per applicazioni eoliche. Sono inoltre Type TC-ER/CIC per impieghi in accordo al CSA C22.1 (CE Code). I cavi identificati con Type TC-ER (Exposed Run) possono essere installati negli impianti industriali per le connessioni tra le canaline posa cavi (cable tray) e l'apparecchiatura senza l'impiego di condotti metallici (metal conduits). Questi cavi possono essere utilizzati in presenza di umidità anche interrati (sono certificati Direct Burial secondo UL 1277) e sono destinati sia al mercato Europeo (CE) che al mercato nord americano. La marcatura metrica stampigliata sulla guaina del cavo ne favorisce la lavorazione e l'installazione.

These are UL Listed, oil resistant, low capacitance servo motor cables (Variable Frequency Drive) planned for fixed application but also for occasional non-cyclical mobile uses. They are used wherever the potential for electromagnetic interference due to drives, frequency converter and motor is high. These cables are different than the traditional ones for their constructive peculiarities, including the double screen, the compounds used for the insulation and the constructive geometry. It is thanks to these and many other factors that this range of cables is able to ensure a low operational capacity, to limit overvoltage peaks which often cause damage to connected equipment and, not least, a consequent reduction of the losses. They are Type TC-ER (Exposed Run) cables suitable for the uses specified by ANSI/NFPA 79 and by articles 336, 392, 501 of the ANSI/NFPA 70 "National Electrical Code" (NEC) and suitable for use in Class I, Division 2, Hazardous Locations. They are certified Flexible Motor Supply Cable for variable speed drives and Wind Turbine Tray Cable (WTTC) for wind applications. They are also Type TC-ER/CIC for uses in accordance with CSA C22.1 (CE Code). The cables identified with Type TC-ER (Exposed Run) can be installed in the industrial plants for the connections between the cable trays and the equipment without the employment of metal conduits. These cables can be used in the presence of humidity also buried (they are certified Direct Burial according UL 1277) and are produced to meet the requirements of the European (EC) and North American markets. The metric marked on the jacket allows an easier processing and installation of the cable.

Dati tecnici - Technical data

Caratteristica - Characteristics	Valore/proprietà - Value/property
Conduttore <i>Conductor</i>	Trefolo flessibile in rame, classe 5 <i>Flexible copper strand, class 5</i>
Isolamento <i>Insulation</i>	Special XLPE (type XHHW-2)
Distinzione conduttori <i>Conductor distinction</i>	Neri numerati + giallo/verde <i>Black numbered + yellow/green</i>
Riempitivi <i>Fillers</i>	Eventuali riempitivi centrali o laterali <i>Central or side fillers, if any</i>
Schermatura <i>Shield</i>	Foglio di alluminio/poliestere, ricopertura 100% + Treccia di rame stagnato Drain wire (per versione con guaina nera) <i>Aluminum/polyester foil, coverage 100% + Tinned copper braid Drain wire (for black jacket version)</i>
Guaina <i>Jacket</i>	Mescola di PVC antioil, colore grigio RAL 7001. Marcatura metrica. <i>PVC compound, oil-resistant, RAL 7001 gray color. Metric marking.</i>
Temperatura di esercizio <i>Temperature range</i>	-40°C (posa fissa); -5°C (posa mobile non ciclica), +90°C <i>-40°C (fixed); -5°C (not fixed), +90°C</i>
Tensione nominale <i>Voltage rating</i>	600 V (TC/CIC/MTW), 1000 V (WTTC), 600/1000 V (IEC)
Tensione di prova <i>Test voltage</i>	6000 V
Raggio di curvatura <i>Bending radius</i>	6 volte diametro esterno del cavo (posa fissa) 20 volte diametro esterno del cavo (posa mobile non ciclica) <i>6 x cable outer diameter (fixed) 20 x cable outer diameter (not fixed)</i>
Riferimenti normativi costruttivi <i>Standards of construction</i>	UL/CSA approvals: (UL) Type TC-ER, MTW, WTTC, Dir Bur, Sun Res Oil Res I, c(UL) Type CIC/TC-ER, Dir Bur, Sun Res, Oil Res I, Type RW90 (≥ 14 AWG); NFPA 79; Class 1, Div. 2 NEC Art. 336, 392, 501, CSA C22.1 Tab.19; UL 1063, UL 1277, UL 2277, CSA C22.2 No.239-09 I Flame res.: FT4/IEEE UL 1685 I UV res.: UNI EN ISO 4892-3 (grigio/gray), UNI EN ISO 4892-2 (nero/black) I Oil res.: Oil Res I UL 1277; Water res.: 90°C UL 1277; Other: Direct Burial UL 1277, Low Voltage Directive (LVD) 2014/35/EU
Riferimenti normativi d'impiego <i>Standards of use</i>	NFPA 79, NFPA 70 (NEC), UL 508a, CSA C22.1 (CE Code), CSA C22.2 No.286

Informazione. Si effettua, su richiesta, un servizio aggiuntivo di taglio a misura certificato UL ("Processed Wire").

Information. An additional UL certified cut-to-length service is carried out on request ("Processed Wire").

Importante: la versione con guaina grigia è con conduttori colorati DIN VDI 0293 ed è disponibile fino ad esaurimento scorte.

Important: the version with gray jacket has DIN VDI 0293 colored conductors and is available while stocks running out.

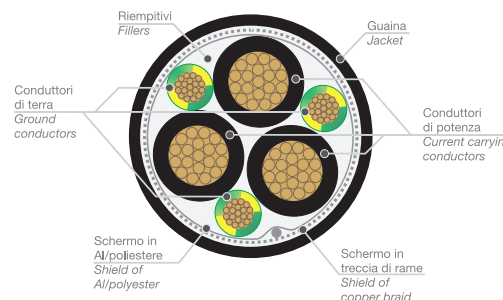

Marcatura - Marking

TEKIMA 0365S – CE VFD (3x16+3G2,5) mm2 600/1000 V - (UL) E361258 TC-ER (3x6+3x14) AWG DIR BUR SUN RES OIL RES I 600V XHHW-2 90°C Dry / 90°C Wet FT4/IEEE 1202 or WTTC or FLEXIBLE MOTOR SUPPLY CABLE 1000V 90°C Dry or MTW 600V c(UL) CONTROL CABLE CIC/TC-ER DIR BUR SUN RES OIL RES I 600V 90°C Dry / 90°C Wet FT4 or RW90 – (prod.reference) = (metric) =

Codifiche e dimensioni - Coding and dimensions

Codice <i>Code</i>	N° di conduttori x sezione <i>Num. conductors x size [mm²]</i>	N° di conduttori x sezione <i>Num. conductors x size [AWG/kcmil]</i>	Diametro <i>Diameter [mm]</i>	Peso <i>Weight [kg/km]</i>
CVFM0003_0365S_□□	(3x6+3G1)	((3x10+3G18)	14,9	343
CVFM0004_0365S_□□	(3x10+3G1,5)	(3x8+3G16)	16,7	489
CVFM0005_0365S_□□	(3x16+3G2,5)	(3x6+3G14)	20,1	798
CVFM0006_0365S_□□	(3x25+3G4)	(3x4+3G12)	24,4	1.203
CVFM0007_0365S_□□	(3x35+3G6)	(3x2+3G10)	27,0	1.572
CVFM0008_0365S_□□	(3x50+3G10)	(3x1+3G8)	32,0	2.272
CVFM0009_0365S_□□	(3x70+3G10)	(3x2/0+3G8)	36,5	2.915
CVFM0010_0365S_□□	(3x95+3G16)	(3x3/0+3G6)	39,8	3.804
CVFM0011_0365S_□□	(3x120+3G16)	(3x4/0+3G6)	44,7	4.698
CVFM0012_0365S_□□	(3x150+3G25)	(3x250+3G4)	48,2	5.837
CVFM0013_0365S_□□	(3x185+3G35)	(3x350+3G2)	52,1	7.116
CVFM0014_0365S_□□	(3x240+3G50)	(3x450+3G1)	58,5	9.221

Composizione del codice - Code composition

CVFM □□□□ _0365S_ □□

Formazione *Construction*

Codice identificativo della particolare formazione del cavo.
Identifier code of the special cable construction.

Colore <i>Color</i>	Inserire <i>To be inserted</i>
Grigio <i>Gray</i>	GR
Nero <i>Black</i>	NE

**SERIES
365S**

Cavi VFD 1xG a bassa capacità, TC-ER/CIC/MTW/WTTC, Dir Bur, Sun Res

Low capacity VFD 1xG cables, TC-ER/CIC/MTW/WTTC, Dir Bur, Sun Res

Posa fissa, schermati - Fixed application, shielded



Impiego - Use

Sono cavi oil resistant UL Listed a bassa capacità progettati per servo motori (Variable Frequency Drive) e per impiego fisso o per impieghi mobili occasionali e non ciclici. Vengono utilizzati dove è alto il rischio di interferenze dovute a inverter, motori, apparecchiature di controllo. Si differenziano rispetto ai cavi tradizionali per le loro peculiarità costruttive, tra le quali il doppio schermo, le mescole di isolamento e le geometrie costruttive. Questa gamma di cavi è in grado di garantire una bassa capacità operativa, di limitare enormemente i picchi di sovratensione spesso causa di danneggiamenti agli apparati collegati e, non ultimo, una conseguente riduzione delle perdite. Sono cavi Type TC-ER (Exposed Run) adatti agli usi specificati dall'ANSI/NFPA 79 e dagli articoli 336, 392, 501 del ANSI/NFPA 70 "National Electrical Code" (NEC) e idonei all'impiego in Class I, Division 2, Hazardous Locations. Sono certificati Flexible Motor Supply Cable per azionamenti a velocità variabile e Wind Turbine Tray Cable (WTTC) per applicazioni eoliche. Sono inoltre Type TC-ER/CIC per impieghi in accordo al CSA C22.1 (CE Code). I cavi identificati con Type TC-ER (Exposed Run) possono essere installati negli impianti industriali per le connessioni tra le canaline posa cavi (cable tray) e l'apparecchiatura senza l'impiego di condotti metallici (metal conduits). Questi cavi possono essere utilizzati in presenza di umidità anche interrati (sono certificati Direct Burial secondo UL 1277) e sono destinati sia al mercato Europeo (CE) che al mercato nord americano. La marcatura metrica stampigliata sulla guaina del cavo ne favorisce la lavorazione e l'installazione.

These are UL Listed, oil resistant, low capacitance servo motor cables (Variable Frequency Drive) planned for fixed application but also for occasional non-cyclical mobile uses. They are used wherever the potential for electromagnetic interference due to drives, frequency converter and motor is high. These cables are different than the traditional ones for their constructive peculiarities, including the double screen, the compounds used for the insulation and the constructive geometry. It is thanks to these and many other factors that this range of cables is able to ensure a low operational capacity, to limit overvoltage peaks which often cause damage to connected equipment and, not least, a consequent reduction of the losses. They are Type TC-ER (Exposed Run) cables suitable for the uses specified by ANSI/NFPA 79 and by articles 336, 392, 501 of the ANSI/NFPA 70 "National Electrical Code" (NEC) and suitable for use in Class I, Division 2, Hazardous Locations. They are certified Flexible Motor Supply Cable for variable speed drives and Wind Turbine Tray Cable (WTTC) for wind applications. They are also Type TC-ER/CIC for uses in accordance with CSA C22.1 (CE Code). The cables identified with Type TC-ER (Exposed Run) can be installed in the industrial plants for the connections between the cable trays and the equipment without the employment of metal conduits. These cables can be used in the presence of humidity also buried (they are certified Direct Burial according UL 1277) and are produced to meet the requirements of the European (EC) and North American markets. The metric marked on the jacket allows an easier processing and installation of the cable.

Dati tecnici - Technical data

Caratteristica - Characteristics	Valore/proprietà - Value/property
Conduttore Conductor	Trefolo flessibile in rame, classe 5 Flexible copper strand, class 5
Isolamento Insulation	Special XLPE (type XHHW-2)
Distinzione conduttori Conductor distinction	Neri numerati + giallo/verde Black numbered + yellow/green
Riempitivi Fillers	Eventuali riempitivi centrali o laterali Central or side fillers, if any
Schermatura Shield	Foglio di alluminio/poliestere, ricopertura 100% + Treccia di rame stagnato Drain wire (per versione con guaina nera) Aluminum/polyester foil, coverage 100% + Tinned copper braid Drain wire (for black jacket version)
Guaina Jacket	Mescola di PVC antiolio, colore grigio RAL 7001. Marcatura metrica. PVC compound, oil-resistant, RAL 7001 gray color. Metric marking.
Temperatura di esercizio Temperature range	-40°C (posa fissa); -5°C (posa mobile non ciclica), +90°C -40°C (fixed); -5°C (not fixed), +90°C
Tensione nominale Voltage rating	600 V (TC/CIC/MTW), 1000 V (WTTC), 600/1000 V (IEC)
Tensione di prova Test voltage	6000 V
Raggio di curvatura Bending radius	6 volte diametro esterno del cavo (posa fissa) 20 volte diametro esterno del cavo (posa mobile non ciclica) 6 x cable outer diameter (fixed) 20 x cable outer diameter (not fixed)
Riferimenti normativi costruttivi Standards of construction	UL/CSA approvals: (UL) Type TC-ER, MTW, WTTC, Dir Bur, Sun Res Oil Res I, c(UL) Type CIC/TC-ER, Dir Bur, Sun Res, Oil Res I, Type RW90 (≥14 AWG); NFPA 79; Class 1, Div. 2 NEC Art. 336, 392, 501, CSA C22.1 Tab.19; UL 1063, UL 1277, UL 2277, UL 2277, CSA C22.2 No.239-09 I Flame res.: FT4/IEEE UL 1685 I UV res.: UNI EN ISO 4892-3 (grigio/gray), UNI EN ISO 4892-2 (nero/black) I Oil res.: Oil Res I UL 1277; Water res.: 90°C UL 1277; Other: Direct Burial UL 1277, Low Voltage Directive (LVD) 2014/35/EU
Riferimenti normativi d'impiego Standards of use	NFPA 79, NFPA 70 (NEC), UL 508a, CSA C22.1 (CE Code), CSA C22.2 No.286

Informazione. Si effettua, su richiesta, un servizio aggiuntivo di taglio a misura certificato UL ("Processed Wire").

Information. An additional UL certified cut-to-length service is carried out on request ("Processed Wire").

Importante: la versione con guaina grigia è con conduttori colorati DIN VDI 0293 ed è disponibile fino ad esaurimento scorte.

Important: the version with gray jacket has DIN VDI 0293 colored conductors and is available while stocks running out.

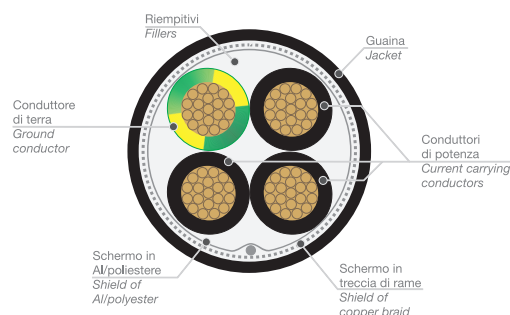

Marcatura - Marking

TEKIMA 0365S – CE VFD (4G16) mm² 600/1000 V - (UL) E361258 TC-ER (4x6) AWG DIR BUR SUN RES OIL RES I 600V XHHW-2 90°C Dry / 90°C Wet FT4/IEEE 1202 or WTTC or FLEXIBLE MOTOR SUPPLY CABLE 1000V 90°C Dry or MTW 600V c(UL) CONTROL CABLE CIC/TC-ER DIR BUR SUN RES OIL RES I 600V 90°C Dry / 90°C Wet FT4 or RW90 – (prod.reference) = (metric) =

Codifiche e dimensioni - Coding and dimensions

Codice <i>Code</i>	N° di conduttori <i>Number of conductors</i>	Sezione Size [mm ²]	Sezione Size [AWG]	Diametro Diameter [mm]	Peso Weight [kg/km]
CV04G100_0365S_□□	4	1	18	9,7	129
CV04G150_0365S_□□	4	1,5	16	10,4	157
CV04G250_0365S_□□	4	2,5	14	11,3	207
CV04G400_0365S_□□	4	4	12	13,1	293
CV04G600_0365S_□□	4	6	10	15,1	414
CV04GB10_0365S_□□	4	10	8	19,2	656
CV04GB16_0365S_□□	4	16	6	22,7	976
CV04GB25_0365S_□□	4	25	4	26,2	1388
CV04GB35_0365S_□□	4	35	2	29,1	1811
CV04GB50_0365S_□□	4	50	1	34,5	2544
CV04GB70_0365S_□□	4	70	2/0	37,8	3425
CV04GB95_0365S_□□	4	95	3/0	44,5	4563
CV04GL12_0365S_□□	4	120	4/0	48,3	5569
CV04GL15_0365S_□□	4	150	250	52,1	6761
CV04GL18_0365S_□□	4	185	350	56,4	8112
CV04GL24_0365S_□□	4	240	450	63,2	10400

Composizione del codice - Code composition

Numero conduttori <i>Number of conductors</i>		Sezione Size		Colore <i>Color</i>	Inserire <i>To be inserted</i>
4	04X	1,0 mm ² , ..., 6,00 mm ²	100, ..., 600	Grigio <i>Gray</i>	GR
		10,0 mm ² , ..., 95,0 mm ²	B10, ..., B95	Nero <i>Black</i>	NE
		120 mm ² , ..., 240 mm ²	L12, ..., L24		

**SERIES
365S**

Cavi VFD 1xG+1xP a bassa capacità, TC-ER/CIC/MTW/WTTC, Dir Bur, Sun Res

Low capacity VFD 1xG+1xP cables, TC-ER/CIC/MTW/WTTC, Dir Bur, Sun Res

Posa fissa, schermati con coppia di segnale - Fixed application, shielded with control pair



Impiego - Use

Sono cavi oil resistant UL Listed a bassa capacità progettati per servo motori (Variable Frequency Drive) e per impiego fisso o per impieghi mobili occasionali e non ciclici. Vengono utilizzati dove è alto il rischio di interferenze dovute a inverter, motori, apparecchiature di controllo. Si differenziano rispetto ai cavi tradizionali per le loro peculiarità costruttive, tra le quali il doppio schermo, le mescole di isolamento e le geometrie costruttive. Questa gamma di cavi è in grado di garantire una bassa capacità operativa, di limitare enormemente i picchi di sovratensione spesso causa di danneggiamenti agli apparati collegati e, non ultimo, una conseguente riduzione delle perdite. Sono cavi Type TC-ER (Exposed Run) adatti agli usi specificati dall'ANSI/NFPA 79 e dagli articoli 336, 392, 501 del ANSI/NFPA 70 "National Electrical Code" (NEC) e idonei all'impiego in Class I, Division 2, Hazardous Locations. Sono certificati Flexible Motor Supply Cable per azionamenti a velocità variabile e Wind Turbine Tray Cable (WTTC) per applicazioni eoliche. Sono inoltre Type TC-ER/CIC per impieghi in accordo al CSA C22.1 (CE Code). I cavi identificati con Type TC-ER (Exposed Run) possono essere installati negli impianti industriali per le connessioni tra le canaline posa cavi (cable tray) e l'apparecchiatura senza l'impiego di condotti metallici (metal conduits). Questi cavi possono essere utilizzati in presenza di umidità anche interrati (sono certificati Direct Burial secondo UL 1277) e sono destinati sia al mercato Europeo (CE) che al mercato nord americano. La marcatura metrica stampigliata sulla guaina del cavo ne favorisce la lavorazione e l'installazione.

These are UL Listed, oil resistant, low capacitance servo motor cables (Variable Frequency Drive) planned for fixed application but also for occasional non-cyclical mobile uses. They are used wherever the potential for electromagnetic interference due to drives, frequency converter and motor is high. These cables are different than the traditional ones for their constructive peculiarities, including the double screen, the compounds used for the insulation and the constructive geometry. It is thanks to these and many other factors that this range of cables is able to ensure a low operational capacity, to limit overvoltage peaks which often cause damage to connected equipment and, not least, a consequent reduction of the losses. They are Type TC-ER (Exposed Run) cables suitable for the uses specified by ANSI/NFPA 79 and by articles 336, 392, 501 of the ANSI/NFPA 70 "National Electrical Code" (NEC) and suitable for use in Class I, Division 2, Hazardous Locations. They are certified Flexible Motor Supply Cable for variable speed drives and Wind Turbine Tray Cable (WTTC) for wind applications. They are also Type TC-ER/CIC for uses in accordance with CSA C22.1 (CE Code). The cables identified with Type TC-ER (Exposed Run) can be installed in the industrial plants for the connections between the cable trays and the equipment without the employment of metal conduits. These cables can be used in the presence of humidity also buried (they are certified Direct Burial according UL 1277) and are produced to meet the requirements of the European (EC) and North American markets. The metric marked on the jacket allows an easier processing and installation of the cable.

Informazione. Si effettua, su richiesta, un servizio aggiuntivo di taglio a misura certificato UL ("Processed Wire").

Information. An additional UL certified cut-to-length service is carried out on request ("Processed Wire").

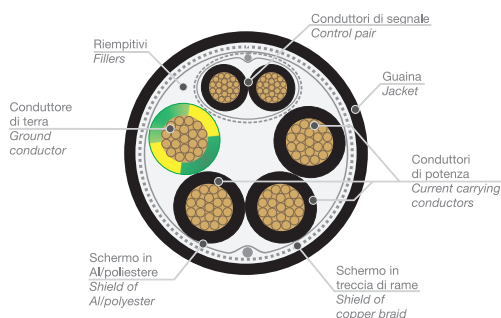

Dati tecnici - Technical data

Caratteristica - Characteristics	Valore/proprietà - Value/property
Conduttore <i>Conductor</i>	Trefolo flessibile in rame, classe 5 <i>Flexible copper strand, class 5</i>
Isolamento <i>Insulation</i>	Special XLPE (type XHHW-2)
Distinzione conduttori <i>Conductor distinction</i>	Neri numerati + giallo/verde <i>Black numbered + yellow/green</i>
Riempitivi <i>Fillers</i>	Eventuali riempitivi centrali o laterali <i>Central or side fillers, if any</i>
Schermatura <i>Shield</i>	Foglio di alluminio/poliestere, ricopertura 100% + Treccia di rame stagnato + Drain wire <i>Aluminum/polyester foil, coverage 100% + Tinned copper braid + Drain wire</i>
Schermatura sulle coppie <i>Shield on pairs</i>	Foglio di alluminio/poliestere, ricopertura 100% + Treccia di rame stagnato + Drain wire <i>Aluminum/polyester foil, coverage 100% + Tinned copper braid + Drain wire</i>
Guaina <i>Jacket</i>	Miscela di PVC antiolio, colore grigio RAL 7001. Marcatura metrica. <i>PVC compound, oil-resistant, RAL 7001 gray color. Metric marking.</i>
Temperatura di esercizio <i>Temperature range</i>	-40°C (posa fissa); -5°C (posa mobile non ciclica), +90°C <i>-40°C (fixed); -5°C (not fixed), +90°C</i>
Tensione nominale <i>Voltage rating</i>	600 V (TC/CIC/MTW), 1000 V (WTTC), 600/1000 V (IEC)
Tensione di prova <i>Test voltage</i>	6000 V
Raggio di curvatura <i>Bending radius</i>	6 volte diametro esterno del cavo (posa fissa) 20 volte diametro esterno del cavo (posa mobile non ciclica) <i>6 x cable outer diameter (fixed) 20 x cable outer diameter (not fixed)</i>
Riferimenti normativi costruttivi <i>Standards of construction</i>	UL/CSA approvals: (UL) Type TC-ER, MTW, WTTC, Dir Bur, Sun Res Oil Res I, c(UL) Type CIC/TC-ER, Dir Bur, Sun Res, Oil Res I, Type RW90 (≥14 AWG); NFPA 79; Class 1, Div. 2 NEC Art. 336, 392, 501, CSA C22.1 Tab.19; UL 1063, UL 1277, UL 2277, CSA C22.2 No.239-09 I Flame res.: FT4/IEEE UL 1685 I UV res.: UNI EN ISO 4892-3 (grigio/gray), UNI EN ISO 4892-2 (nero/black) I Oil res.: Oil Res I UL 1277; Water res.: 90°C UL 1277; Other: Direct Burial UL 1277, Low Voltage Directive (LVD) 2014/35/EU
Riferimenti normativi d'impiego <i>Standards of use</i>	NFPA 79, NFPA 70 (NEC), UL 508a, CSA C22.1 (CE Code), CSA C22.2 No.286

Marcatura - Marking

TEKIMA 0365S – CE VFD ((4G16)+1X(2X1,5)) mm² 600/1000 V - (UL) E361258 TC-ER ((4X6)+1X(2X16)) AWG DIR BUR SUN RES OIL RES I 600V XHHW-2 90°C Dry / 90°C Wet FT4/IEEE 1202 or WTTTC or FLEXIBLE MOTOR SUPPLY CABLE 1000V 90°C Dry or MTW 600V c(UL) CONTROL CABLE CIC/TC-ER DIR BUR SUN RES OIL RES I 600V 90°C Dry / 90°C Wet FT4 or RW90 – (prod. reference) = (metric) =

Codifiche e dimensioni - Coding and dimensions

Codice Code	N° di conduttori x sezione Num. conductors x size [mm ²]	N° di conduttori x sezione Num. conductors x size [AWG/ kcmil]	Diametro Diameter [mm]	Peso Weight [kg/km]
CVFM0101_0365S_□□	(4G1,5+1x(2x1))	(4x16+1x(2x18))	14,3	267
CVFM0102_0365S_□□	(4G1,5+1x(2x1,5))	(4x16+1x(2x16))	14,9	286
CVFM0103_0365S_□□	(4G2,5+1x(2x1))	(4x14+1x(2x18))	15,0	316
CVFM0104_0365S_□□	(4G2,5+1x(2x1,5))	(4x14+1x(2x16))	15,5	339
CVFM0105_0365S_□□	(4G4+1x(2x1))	(4x12+1x(2x18))	16,5	414
CVFM0106_0365S_□□	(4G4+1x(2x1,5))	(4x12+1x(2x16))	17,0	432
CVFM0107_0365S_□□	(4G4+1x(2x2,5))	(4x12+1x(2x14))	17,4	466
CVFM0108_0365S_□□	(4G6+1x(2x1))	(4x10+1x(2x18))	17,5	508
CVFM0109_0365S_□□	(4G6+1x(2x1,5))	(4x10+1x(2x16))	17,6	519
CVFM0110_0365S_□□	(4G6+1x(2x2,5))	(4x10+1x(2x14))	18,5	553
CVFM0111_0365S_□□	(4G10+1x(2x1))	(4x8+1x(2x18))	22,4	804
CVFM0112_0365S_□□	(4G10+1x(2x1,5))	(4x8+1x(2x16))	22,7	820
CVFM0113_0365S_□□	(4G10+1x(2x2,5))	(4x8+1x(2x14))	23,3	851
CVFM0114_0365S_□□	(4G16+1x(2x1))	(4x6+1x(2x18))	24,5	1.060
CVFM0115_0365S_□□	(4G16+1x(2x1,5))	(4x6+1x(2x16))	24,8	1.081
CVFM0116_0365S_□□	(4G16+1x(2x2,5))	(4x6+1x(2x14))	25,4	1.122
CVFM0117_0365S_□□	(4G25+1x(2x1,5))	(4x4+1x(2x16))	28,2	1.494
CVFM0118_0365S_□□	(4G25+1x(2x2,5))	(4x4+1x(2x14))	28,3	1.522
CVFM0119_0365S_□□	(4G35+1x(2x1,5))	(4x2+1x(2x16))	30,8	1.910
CVFM0120_0365S_□□	(4G35+1x(2x2,5))	(4x2+1x(2x14))	31,2	1.940
CVFM0121_0365S_□□	(4G50+1x(2x1,5))	(4x1+1x(2x16))	35,8	2.613

Composizione del codice - Code composition

CVFM □□□□ _0365S_ □□

Formazione
Construction

Codice identificativo della particolare formazione del cavo.
Identifier code of the special cable construction.

Colore
Color

Nero
Black

Inserire
To be inserted

NE

**SERIES
370S**

Cavi multipolari a sicurezza intrinseca

Intrinsically safe cables

Posa fissa, schermati - Fixed application, shielded



Impiego - Use

Cavi di controllo con guaina e isolamento dei conduttori di colore blu per una facile identificazione. Sono progettati per impiego fisso o per impieghi mobili occasionali e non ciclici. Sono usati in zone a pericolo di esplosione per circuiti a sicurezza intrinseca e rispondono ai requisiti della norma EN 60079-14. La guaina realizzata con mescola di PVC garantisce una buona flessibilità ed una ottima resistenza all'abrasione.

These are control cables with a blue outer sheath and a blue conductors' insulation for easy identification. They are designed for fixed installations but also for occasional non-cyclical mobile uses in intrinsically safe circuits. They are used in hazardous areas for intrinsically safe circuits and they meet the requirements of EN 60079-14. The jacket, made of PVC compound, grants a good flexibility and a very good resistance to abrasion.

Informazione. Si effettua, su richiesta, un servizio aggiuntivo di taglio a misura certificato UL ("Processed Wire").

Information. An additional UL certified cut-to-length service is carried out on request ("Processed Wire").

Dati tecnici - Technical data

Caratteristica - Characteristics	Valore/proprietà - Value/property
Conduttore <i>Conductor</i>	Trefolo in rame <i>Copper strand</i>
Isolamento <i>Insulation</i>	TKblend®-R
Distinzione conduttori <i>Conductor distinction</i>	Blu RAL 5015 numerati <i>Blue RAL 5015, numbered</i>
Schermatura <i>Shield</i>	Treccia di rame, ricopertura nom. 75% <i>Copper braid, nom. coverage 75%</i>
Guaina <i>Jacket</i>	Mescola di PVC, colore blu RAL 5015 <i>PVC compound, blue RAL 5015</i>
Temperatura di esercizio <i>Temperature range</i>	-5°C, +80°C (posa mobile); -25°C, +80°C (posa fissa) -5°C, +80°C (not fixed); -25°C, +80°C (fixed)
Tensione nominale <i>Voltage rating</i>	300 V (UL), 300/500V (IEC)
Tensione di prova <i>Test voltage</i>	4000 V (cond. / cond.) 2000 V (cond. / shield)
Induttanza lineare <i>Linear inductance</i>	<0,7 mH/km
Capacità tipica (C/C) <i>Typical capacity</i>	0,11 µF/km @ 20°C
Capacità massima (C/S) <i>Max capacity</i>	0,19 µF/km @ 20°C
Raggio di curvatura <i>Bending radius</i>	8 volte diametro esterno del cavo <i>8 x cable outer diameter</i>
Riferimenti normativi costruttivi <i>Standards of construction</i>	Flame res.: IEC 60332-1-2, CSA FT1 I Other: UL 758, CSA AWM I/II A/B, cURus AWM Style 2655 or 2464
Riferimenti normativi d'impiego <i>Standards of use</i>	ANSI/NFPA 79, UL 508a, Style 2655 or 2464

Marcatura - Marking

TEKIMA 0370S - CE (2x2x0,75) mm² 80°C 300 V - (UR) AWM Style 2655 (2x2x19) AWG 80°C 300 V E314444 - Class I/II A/B FT1 - (prod.reference) = (metric) =

Codifiche e dimensioni - Coding and dimensions

Codice <i>Code</i>	N. conduttori x sezione <i>Num. conductors x Size [mm²]</i>	N. conduttori x sezione <i>Num. conductors x Size [AWG]</i>	Diametro <i>Diameter [mm]</i>	Peso <i>Weight [kg/km]</i>
CVFS0001_0370S_BL	(1x2x0,75)	(1x2x19)	7,2	69
CVFS0002_0370S_BL	(2x2x0,75)	(2x2x19)	11,2	166
CVFS0003_0370S_BL	(4x2x0,75)	(4x2x19)	13,0	222
CVFS0004_0370S_BL	(25x0,25)	(25x24)	10,6	172
CVFS0005_0370S_BL	(3x0,75)	(3x19)	7,7	87

**SERIES
380**

Cavi multipolari multinorma in silicone per alte temperature



High temperature multi-norm silicone cables

Posa fissa, non schermati - Fixed application, unshielded



cRU[®]US

RoHS

CE UK
CA

Impiego - Use

Sono cavi realizzati in silicone e progettati per impiego fisso a bordo macchina o per impieghi mobili occasionali e non ciclici. Vengono utilizzati per l'equipaggiamento di apparecchiature destinate sia al mercato Europeo (CE) che ai mercati nord americani e canadesi dove sono richieste temperature di esercizio che possono raggiungere i 180°C. La buona flessibilità li rende ideali per installazioni in spazi ridotti e l'ottima resistenza alla fiamma li rende adatti alla posa in qualsiasi ambiente industriale. La marcatura metrica stampigliata sulla guaina del cavo ne favorisce la lavorazione e l'installazione.

They are cables designed for fixed applications or for occasional and non-cyclic mobile use. They are used for equipments meant for the European (EC), North American and Canadian markets where the temperatures can reach up to 180°C. Thanks to their flexibility they are easy to install in narrow spaces and the good flame resistance makes them suitable for the installation in any industrial environment. The metric marked on the jacket allows an easier processing and installation of the cable.

Informazione. Si effettua, su richiesta, un servizio aggiuntivo di taglio a misura certificato UL ("Processed Wire").

Information. An additional UL certified cut-to-length service is carried out on request ("Processed Wire").

Marcatura - Marking

TEKIMA 03800 – CE 4G1,5 mm² 180°C 450/750 V – c(UR)us AWM Style 4476
E314444 4x16 AWG 150°C 600 V AWM II A/B FT1 – (prod.reference) = (metric) =

Dati tecnici - Technical data

Caratteristica - Characteristics	Valore/proprietà - Value/property
Conduttore <i>Conductor</i>	Trefolo flessibile in rame, classe 5 <i>Flexible copper strand, class 5</i>
Isolamento <i>Insulation</i>	Miscela di silicone <i>Silicone compound</i>
Distinzione conduttori <i>Conductor distinction</i>	Colorati* secondo HD 308 S2 e neri numerati + giallo/verde (a partire dai 6 conduttori) <i>Colored* according to HD 308 S2 and black numbered + yellow/green (beginning from 6 conductors)</i>
Riempitivi <i>Fillers</i>	Eventuali riempitivi centrali o laterali <i>Central or side fillers, if any</i>
Guaina <i>Jacket</i>	Miscela di silicone, colore nero. Marcatura metrica. <i>Silicone compound, black color. Metric marking.</i>
Temperatura di esercizio <i>Temperature range</i>	-60°C; +150°C (UL/CSA); +180°C (IEC)
Tensione nominale <i>Voltage rating</i>	600 V (UL/CSA); 450/750 V (IEC)
Tensione di prova <i>Test voltage</i>	2000 V
Raggio di curvatura <i>Bending radius</i>	5 volte diametro esterno del cavo (posa fissa) 10 volte diametro esterno del cavo (posa mobile non ciclica) <i>5 x cable outer diameter (fixed)</i> <i>10 x cable outer diameter (not fixed)</i>
Riferimenti normativi costruttivi <i>Standards of construction</i>	Flame res.: IEC 60332-1-2, UL/CSA FT1 Other: CEI EN 60228, VDE 0295, UL 1581, UL 758, CSA AWM II A/B, cURus AWM Style 4476, 2014/35/EC (Low Voltage Directive)
Riferimenti normativi d'impiego <i>Standards of use</i>	ANSI/NFPA 79, UL 508a, CSA C22.1 (CE Code), CSA C22.2 No.286, Style 4476

* 2 cond.: blu, marrone; 3 cond.: giallo/verde, blu, marrone; 4 cond.: giallo/verde, marrone, nero, grigio; 5 cond.: giallo/verde, blu, marrone, nero, grigio

* 2 cond.: blue, brown; 3 cond.: yellow/green, blue, brown; 4 cond.: yellow/green, brown, black, gray; 5 cond.: yellow/green, blue, brown, black gray

Codifiche e dimensioni - Coding and dimensions

Codice <i>Code</i>	Numero di conduttori <i>Number of conductors</i>	Sezione <i>Size [mm²]</i>	Sezione <i>Size [AWG]</i>	Diametro <i>Diameter [mm]</i>	Peso <i>Weight [kg/km]</i>
CV02X050_03800_NE ⁽¹⁾	2	0,5	20	7,4	71
CV02X100_03800_NE	2	1	18	8,2	92
CV02X150_03800_NE	2	1,5	16	8,8	110
CV02X250_03800_NE	2	2,5	14	9,6	143
CV03G050_03800_NE ⁽¹⁾	3	0,5	20	7,8	83
CV03G100_03800_NE	3	1	18	8,6	107
CV03G150_03800_NE	3	1,5	16	9,3	131
CV03G250_03800_NE	3	2,5	14	10,2	174
CV03G400_03800_NE	3	4	12	11,5	237
CV03G600_03800_NE	3	6	10	14,9	382
CV04G050_03800_NE ⁽¹⁾	4	0,5	20	8,5	100
CV04G100_03800_NE	4	1	18	9,4	130
CV04G150_03800_NE	4	1,5	16	10,1	160
CV04G250_03800_NE	4	2,5	14	11,1	213
CV04G400_03800_NE	4	4	12	12,6	296

Codice Code	Numero di conduttori Number of conductors	Sezione Size [mm ²]	Sezione Size [AWG]	Diametro Diameter [mm]	Peso Weight [kg/km]
CV04G600_03800_NE	4	6	10	16,4	478
CV04GB10_03800_NE	4	10	8	22,0	818
CV05G050_03800_NE ⁽¹⁾	5	0,5	20	9,2	118
CV05G100_03800_NE	5	1	18	10,6	157
CV05G150_03800_NE	5	1,5	16	11,1	194
CV05G250_03800_NE	5	2,5	14	12,2	245
CV05G400_03800_NE	5	4	12	14,2	373
CV05G600_03800_NE	5	6	10	18,0	583
CV07G050_03800_NE ⁽¹⁾	7	0,5	20	9,9	140
CV07G100_03800_NE	7	1	18	11,1	185
CV07G150_03800_NE	7	1,5	16	12,0	230
CV12G100_03800_NE	12	1	18	14,9	339
CV12G150_03800_NE	12	1,5	16	16,1	424
CV18G150_03800_NE	18	1,5	16	18,8	594
CV25G150_03800_NE	25	1,5	16	22,9	865

(1) I conduttori sono cordati in AWG, la sezione effettiva è di 0,518 mm²

(1) The conductors are stranded in AWG, the effective section is 0.518 mm²

Composizione del codice - Code composition

CV	□□□	□□□	_03800_	□□	Colore Color	Inserire To be inserted
					Nero - Black	NE
Numero conduttori Number of conductors	Inserire To be inserted	Sezione Size	Inserire To be inserted			
2	02X	0,34 mm ² , ..., 6,00 mm ²	034, ..., 600			
3, ..., 25	03G, ..., 25G	10 mm ²	B10			

**SERIES
380S**

Cavi multipolari multinorma in silicone per alte temperature



High temperature multi-norm silicone cables

Posa fissa, schermati - Fixed application, shielded



Impiego - Use

Sono cavi realizzati in silicone e progettati per impiego fisso a bordo macchina o per impieghi mobili occasionali e non ciclici. Vengono utilizzati per l'equipaggiamento di apparecchiature destinate sia al mercato Europeo (CE) che ai mercati nord americani e canadesi dove sono richieste temperature di esercizio che possono raggiungere i 180°C. La buona flessibilità li rende idonei per installazioni in spazi ridotti e l'ottima resistenza alla fiamma li rende adatti alla posa in qualsiasi ambiente industriale. La marcatura metrica stampigliata sulla guaina del cavo ne favorisce la lavorazione e l'installazione.

These are machine tool wire cables planned also for occasional non-cyclical mobile uses. They are normally used for equipments meant for the European (EC), North American and Canadian markets. Their good oil and abrasion resistance permit their use in static connections without particular protections and without compromising the original electrical and mechanical properties. The good flame resistance makes them suitable for the installation in any industrial environment. The metric marked on the jacket allows an easier processing and installation of the cable.

Informazione. Si effettua, su richiesta, un servizio aggiuntivo di taglio a misura certificato UL ("Processed Wire").
Information. An additional UL certified cut-to-length service is carried out on request ("Processed Wire").

Dati tecnici - Technical data

Caratteristica - Characteristics	Valore/proprietà - Value/property
Conduttore <i>Conductor</i>	Trefolo flessibile in rame, classe 5 <i>Flexible copper strand, class 5</i>
Isolamento <i>Insulation</i>	Mescola di silicone <i>Silicone compound</i>
Distinzione conduttori <i>Conductor distinction</i>	Colorati* secondo HD 308 S2 e neri numerati + giallo/verde (a partire dai 6 conduttori) <i>Colored* according to HD 308 S2 and black numbered + yellow/green (beginning from 6 conductors)</i>
Riempitivi <i>Fillers</i>	Eventuali riempitivi centrali o laterali <i>Central or side fillers, if any</i>
Schermatura <i>Shield</i>	Treccia di rame stagnato, ricopertura nom. 85% <i>Tinned copper braid, nom. coverage 85%</i>
Guaina <i>Jacket</i>	Mescola di silicone, colore nero. Marcatura metrica. <i>Silicone compound, black color. Metric marking.</i>
Temperatura di esercizio <i>Temperature range</i>	60°C; +150°C (UL/CSA); +180°C (IEC)
Tensione nominale <i>Voltage rating</i>	600 V (UL/CSA); 450/750 V (IEC)
Tensione di prova <i>Test voltage</i>	2000 V
Raggio di curvatura <i>Bending radius</i>	5 volte diametro esterno del cavo (posa fissa) 12 volte diametro esterno del cavo (posa mobile non ciclica) <i>5 x cable outer diameter (fixed) 12 x cable outer diameter (not fixed)</i>
Riferimenti normativi costruttivi <i>Standards of construction</i>	Flame res.: IEC 60332-1-2, UL/CSA FT1 Other: CEI EN 60228, VDE 0295, UL 1581, UL 758, CSA AWM II A/B, cURus AWM Style 4476, 2014/35/EC (Low Voltage Directive)
Riferimenti normativi d'impiego <i>Standards of use</i>	ANSI/NFPA 79, UL 508a, CSA C22.1 (CE Code), CSA C22.2 No.286, Style 4476

* 2 cond.: blu, marrone; 3 cond.: giallo/verde, blu, marrone; 4 cond.: giallo/verde, marrone, nero, grigio; 5 cond.: giallo/verde, blu, marrone, nero, grigio
* 2 cond.: blue, brown; 3 cond.: yellow/green, blue, brown; 4 cond.: yellow/green, brown, black, gray; 5 cond.: yellow/green, blue, brown, black gray

Marcatura - Marking

TEKIMA 0380S - CE 4G1,5 mm² 180°C 450/750 V - c(UR)us AWM Style 4476 E314444 4x16 AWG 150°C 600 V AWM II A/B FT1 - (prod.reference) = (metric) =

Codifiche e dimensioni - Coding and dimensions

Codice <i>Code</i>	Numero di conduttori <i>Number of conductors</i>	Sezione Size [mm ²]	Sezione Size [AWG]	Diametro Diameter [mm]	Peso Weight [kg/km]
CV02X100_0380S_NE	2	1	18	9,0	110
CV02X150_0380S_NE	2	1,5	16	9,6	125
CV03G050_0380S_NE ⁽¹⁾	3	0,5	20	8,6	100
CV03G100_0380S_NE	3	1	18	9,5	130
CV03G150_0380S_NE	3	1,5	16	10,1	150
CV03G250_0380S_NE	3	2,5	14	11,0	195

Cavi multipolari per posa fissa - Cables for fixed applications

Codice Code	Numero di conduttori Number of conductors	Sezione Size [mm ²]	Sezione Size [AWG]	Diametro Diameter [mm]	Peso Weight [kg/km]
CV03G400_0380S_NE	3	4	12	12,3	255
CV04G050_0380S_NE ⁽¹⁾	4	0,5	20	9,3	125
CV04G100_0380S_NE	4	1	18	10,2	150
CV04G150_0380S_NE	4	1,5	16	10,9	185
CV04G250_0380S_NE	4	2,5	14	11,9	230
CV04G400_0380S_NE	4	4	12	13,4	320
CV04G600_0380S_NE	4	6	10	17,2	490
CV04GB10_0380S_NE	4	10	8	22,8	785
CV05G050_0380S_NE ⁽¹⁾	5	0,5	20	10,0	140
CV05G100_0380S_NE	5	1	18	11,0	180
CV05G150_0380S_NE	5	1,5	16	11,8	210
CV05G250_0380S_NE	5	2,5	14	12,9	275
CV05G400_0380S_NE	5	4	12	14,9	385
CV05G600_0380S_NE	5	6	10	18,7	570
CV07G100_0380S_NE	7	1	18	11,9	215
CV07G150_0380S_NE	7	1,5	16	12,8	265
CV12G150_0380S_NE	12	1,5	16	16,9	435
CV18G150_0380S_NE	18	1,5	16	19,6	595
CV25G150_0380S_NE	25	1,5	16	24,1	820

(1) I conduttori sono cordati in AWG, la sezione effettiva è di 0,518 mm²

(1) The conductors are stranded in AWG, the effective section is 0.518 mm²

Composizione del codice - Code composition

CV □□□ □□□ _0380S_ □□				Colore Color	Inserire To be inserted
Numero conduttori Number of conductors	Inserire To be inserted	Sezione Size	Inserire To be inserted	Nero - Black	NE
2	02X	0,34 mm ² , ..., 6,00 mm ²	034, ..., 600		
3, ..., 25	03G, ..., 25G	10 mm ²	B10		

**SERIES
8110**

Power and Control Tray Cable, TC-ER-HL/CIC/MTW/WTTC/AWM

Direct Burial, Sun Res, Hazardous Locations



"UL Listed", posa fissa, non schermati - Fixed application, unshielded



Impiego - Use

Cavi UL Listed non schermati costruiti per gli usi specificati dall'ANSI/NFPA 79, dagli articoli 336, 392, 501 del ANSI/NFPA 70 "National Electrical Code" (NEC) e dal CSA C22.1 (CE Code). Per applicazioni in Hazardous Locations, la versione TC-ER è idonea all'impiego in Class I, Division 2 mentre la versione TC-ER-HL* è idonea all'impiego in Class I, Division 1. Possono essere impiegati per impiego fisso e mobile occasionale e non ciclico anche in catena portacavi fino a 5 metri e per formazioni da 0.5 mm² fino a 2.5 mm² con un massimo di 6 conduttori privo di sollecitazioni a trazione. I cavi identificati con Type TC-ER (Exposed Run) possono essere installati negli impianti industriali per le connessioni tra le canaline posa cavi (cable tray) e l'apparecchiatura senza l'impiego di condotti metallici (metal conduits) o cavi armati Type MC (Metal Clad Cable); tale tipo di connessioni viene definito Open Wiring. I cavi Type TC-ER / MTW devono rispondere ai requisiti di resistenza all'impatto richiesti per i cavi Type MC, sono oil resistant, sun resistant e possono essere utilizzati in presenza di umidità anche interrati (sono certificati Direct Burial secondo UL 1277). Questi cavi sono certificati anche Flexible Motor Supply Cable per azionamenti a velocità variabile e Wind Turbine Tray Cable (WTTC) per applicazioni eoliche.

Unshielded UL Listed cables built for the uses specified by ANSI/NFPA 79, by Art. 336, 392, 501 of ANSI/NFPA 70 "National Electrical Code" (NEC) and by CSA C22.1 (CE Code). For applications in Hazardous Locations, the TC-ER version is suitable for use in Class I, Division 2 while the TC-ER-HL version is suitable for use in Class I, Division 1. They can be used for fixed and occasional and non-cyclical mobile use also in drag-chains up to 5 meters and for sizes from 0.5 mm² to 2.5 mm² with a maximum of 6 conductors without tensile stress. The cables identified with Type TC-ER (Exposed Run) can be installed in the industrial plants for the connections between the cable trays and the equipment without the employment of metal conduits or reinforced cables Type MC (Metal Clad Cable); this type of connection is called Open Wiring. The TC-ER / MTW type cables must comply with the impact resistance requirements required for MC type cables, they are oil resistant, sun resistant and can be used in the presence of humidity also buried (they are certified Direct Burial according UL 1277). These cables are also certified Flexible Motor Supply Cable for variable speed drives and Wind Turbine Tray Cable (WTTC) for wind turbine applications.*

Informazione. Si effettua, su richiesta, un servizio aggiuntivo di taglio a misura certificato UL ("Processed Wire").

Information. An additional UL certified cut-to-length service is carried out on request ("Processed Wire").

* Importante. La versione TC-ER-HL per installazioni in Hazardous Locations Class I, Division 1 è su specifica richiesta.

* Important. The TC-ER-HL version for installations in Hazardous Locations Class I, Division 1 is upon specific request.

Dati tecnici - Technical data

Caratteristica - Characteristics	Valore/proprietà - Value/property
Conduttore Conductor	Trefolo flessibile in rame, classe 5 Flexible copper strand, class 5
Isolamento Insulation	TKblend®-R
Distinzione conduttori Conductor distinction	Neri numerati + giallo/verde (a partire dai 3 conduttori) Black numbered + yellow/green (beginning from 3 conductors)
Riempitivi Fillers	Eventuali riempitivi centrali o laterali Central or side fillers, if any
Guaina Jacket	Miscela di PVC antiolio, colore grigio RAL 7001. Marcatura metrica. PVC compound, oil-resistant, RAL 7001 gray color. Metric marking.
Temperatura di esercizio Temperature range	+90°C (dry conditions), +75°C (wet conditions) -40°C (posa fissa); -5°C (mobile) -40°C (fixed); -5°C (not fixed)
Tensione nominale Voltage rating	600 V (TC/CIC/MTW), 1000 V (AWM/WTTC), 600/1000 V (IEC)
Spark test	6000 V
Raggio di curvatura Bending radius	4 volte diametro esterno del cavo (15 volte diametro esterno del cavo per movimentazioni non continue) 4 x cable outer diameter (15 x cable outer diameter for non-cyclical mobile uses)
Riferimenti normativi costruttivi Standards of construction	UL/CSA approvals: (UL) Type TC-ER-HL* (18 AWG-1000 kcmil), MTW, WTTC, Dir Bur, Sun Res, Oil Res I, c(UL) Type CIC/TC-ER (18 AWG-4/0 AWG), Dir Bur, Sun Res, Oil Res I, cURus AWM Style 21179, AWM I/II A/B; Class 1, Div.1* or Div.2 NEC Art. 336, 392, 501; CSA C22.1 Tab.19; UL 1581, UL 758, UL 1277, UL 1063, UL 2277, CSA C22.2 No.230-09 e No. 239-09 I Flame res.: FT1, FT4, IEC 60332-1-2, IEC 60332-3-24 I UV res.: UNI EN ISO 4892-3 (grigio/gray), UNI EN ISO 4892-2 (nero/black) I Other: Low Voltage Directive (LVD) 2014/35/EU
Riferimenti normativi d'impiego Standards of use	NFPA 79, NFPA 70 (NEC), CSA C22.1 (CE Code), CSA C22.2 No.286, Style 21179

Marcatura - Marking

TEKIMA 81100 - CE 4G2,5 mm² (UL) E361258 TC-ER-HL 4x14 AWG DIR BUR SUN RES OIL RES I 600V THHW 90°C Dry / 75°C Wet FT4/IEE 1202 or WTTC or FLEXIBLE MOTOR SUPPLY CABLE 1000V 90°C Dry or MTW 600V or AWM 21179 90°C 1000V c(UL) CONTROL CABLE CIC/TC-ER DIR BUR SUN RES OIL RES I 600V 90°C Dry / 75°C Wet PVC FT4 or AWM I/II A/B 90°C 1000V FT1 14 AWG - (prod.reference) = (metric) =

Codifiche e dimensioni - Coding and dimensions

Codice Code	Numero di conduttori Number of conductors	Sezione Size [mm ²]	Sezione Size [AWG]	Diametro Diameter [mm]	Peso Weight [kg/km]
CV02X100_81100_GR**	2	1	18	7,9	87
CV02X150_81100_GR**	2	1,5	16	8,5	106
CV02X250_81100_GR**	2	2,5	14	9,3	137
CV03G100_81100_GR	3	1	18	8,3	102
CV03G150_81100_GR	3	1,5	16	9	127
CV03G250_81100_GR	3	2,5	14	9,8	166
CV03G400_81100_GR	3	4	12	11,2	231

Cavi multipolari per posa fissa - Cables for fixed applications

Codice Code	Numero di conduttori Number of conductors	Sezione Size [mm ²]	Sezione Size [AWG]	Diametro Diameter [mm]	Peso Weight [kg/km]
CV03G600_81100_GR	3	6	10	12,5	310
CV03GB10_81100_GR	3	10	8	17	547
CV03GB16_81100_GR	3	16	6	20,7	838
CV04G100_81100_GR	4	1	18	9,1	125
CV04G150_81100_GR	4	1,5	16	9,8	155
CV04G250_81100_GR	4	2,5	14	10,7	205
CV04G400_81100_GR	4	4	12	12,3	290
CV04G600_81100_GR	4	6	10	14,4	410
CV04GB10_81100_GR	4	10	8	18,5	679
CV04GB16_81100_GR	4	16	6	23,7	1109
CV04GB25_81100_GR	4	25	4	27,2	1569
CV04GB35_81100_GR	4	35	2	30,1	2041
CV04GB50_81100_GR	4	50	1	36,6	2967
CV04GB70_81100_GR	4	70	2/0	41,7	3971
CV04GB95_81100_GR	4	95	3/0	46,7	5198
CV04GL12_81100_GR	4	120	4/0	49,3	6169
CV04GL15_81100_GR	4	150	250	54,9	7700
CV04GL18_81100_GR	4	185	350	59,2	9190
CV04GL24_81100_GR	4	240	450	65,9	11735
CV05G100_81100_GR	5	1	18	9,9	150
CV05G150_81100_GR	5	1,5	16	10,7	187
CV05G250_81100_GR	5	2,5	14	11,8	251
CV05G400_81100_GR	5	4	12	14,3	379
CV05G600_81100_GR	5	6	10	15,8	501
CV05GB10_81100_GR	5	10	8	20,5	840
CV05GB16_81100_GR	5	16	6	26,1	1362
CV05GB25_81100_GR	5	25	4	30,3	1953
CV05GB35_81100_GR	5	35	2	33,5	2539
CV05GB50_81100_GR	5	50	1	40,8	3697
CV05GB70_81100_GR	5	70	2/0	47,9	5106
CV05GB95_81100_GR	5	95	3/0	51,9	6460
CV05GL12_81100_GR	5	120	4/0	54,9	7683
CV07G100_81100_GR	7	1	18	10,8	185
CV07G150_81100_GR	7	1,5	16	11,7	234
CV07G250_81100_GR	7	2,5	14	12,8	315
CV07G400_81100_GR	7	4	12	15,6	480
CV09G150_81100_GR	9	1,5	16	n.a.	n.a.
CV12G100_81100_GR	12	1	18	14,7	335
CV12G150_81100_GR	12	1,5	16	15,9	421
CV12G250_81100_GR	12	2,5	14	17,5	568
CV18G100_81100_GR	18	1	18	17,1	466
CV18G150_81100_GR	18	1,5	16	18,6	594
CV18G250_81100_GR	18	2,5	14	20,5	807
CV25G100_81100_GR	25	1	18	19,5	617
CV25G150_81100_GR	25	1,5	16	22,3	847

** In accordo a NFPA 70 (NEC) e CSA C22.1 (CEC) cavi con 2 conduttori non sono Exposed Run (ER).

** According to NFPA 70 (NEC) and CSA C22.1 (CEC) cables with 2 conductors are not Exposed Run (ER).

Composizione del codice - Code composition

CV □□ X □□□ _81100_GR

Numero conduttori Number of conductors	Inserire To be inserted
2	02X
3, ..., 25	03G, ..., 25G

Sezione Size	Inserire To be inserted
1,00 mm ² , ..., 6,00 mm ²	100, ..., 600
10,0 mm ² , ..., 95,0 mm ²	B10, ..., B95
120 mm ² , ..., 185 mm ²	L12, ..., L18

**SERIES
8110S**

Power and Control Tray Cable, TC-ER-HL/CIC/MTW/WTTC/AWM

Direct Burial, Sun Res, Hazardous Locations



"UL Listed", posa fissa, schermati - Fixed application, shielded

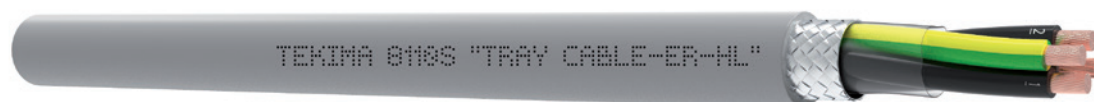

Impiego - Use

Cavi UL Listed schermati costruiti per gli usi specificati dall'ANSI/NFPA 79, dagli articoli 336, 392, 501 del ANSI/NFPA 70 "National Electrical Code" (NEC) e dal CSA C22.1 (CE Code). Per applicazioni in Hazardous Locations, la versione TC-ER è idonea all'impiego in Class I, Division 2 mentre la versione TC-ER-HL* è idonea all'impiego in Class I, Division 1. I cavi identificati con Type TC-ER (Exposed Run) possono essere installati negli impianti industriali per le connessioni tra le canaline posa cavi (cable tray) e l'apparecchiatura senza l'impiego di condotti metallici (metal conduits) o cavi armati Type MC (Metal Clad Cable); tale tipo di connessioni viene definito Open Wiring. I cavi Type TC-ER / MTW devono rispondere ai requisiti di resistenza all'impatto richiesti per i cavi Type MC, sono oil resistant, sun resistant e possono essere utilizzati in presenza di umidità anche interrati (sono certificati Direct Burial secondo UL 1277). Questi cavi sono certificati anche Flexible Motor Supply Cable per azionamenti a velocità variabile e Wind Turbine Tray Cable (WTTC) per applicazioni eoliche.

Shielded UL Listed cables built for the uses specified by ANSI/NFPA 79, by Art. 336, 392, 501 of ANSI/NFPA 70 "National Electrical Code" (NEC) and by CSA C22.1 (CE Code). For applications in Hazardous Locations, the TC-ER version is suitable for use in Class I, Division 2 while the TC-ER-HL version is suitable for use in Class I, Division 1. The cables identified with Type TC-ER (Exposed Run) can be installed in the industrial plants for the connections between the cable trays and the equipment without the employment of metal conduits or reinforced cables MC type (Metal Clad Cable); this type of connection is called Open Wiring. The TC-ER / MTW type cables must comply with the impact resistance requirements required for MC type cables, they are oil resistant, sun resistant and can be used in the presence of humidity also buried (they are certified Direct Burial according UL 1277). These cables are also certified Flexible Motor Supply Cable for variable speed drives and Wind Turbine Tray Cable (WTTC) for wind turbine applications.*

Informazione. Si effettua, su richiesta, un servizio aggiuntivo di taglio a misura certificato UL ("Processed Wire").

Information. An additional UL certified cut-to-length service is carried out on request ("Processed Wire").

* Importante. La versione TC-ER-HL per installazioni in Hazardous Locations Class I, Division 1 è su specifica richiesta.

* Important. The TC-ER-HL version for installations in Hazardous Locations Class I, Division 1 is upon specific request.

Marcatura - Marking

TEKIMA 8110S – CE 4G2,5 mm² (UL) E361258 TC-ER-HL4x14 AWG DIR BUR SUN RES OIL RES I 600V THHW 90°C Dry / 75°C Wet FT4/IEEE 1202 or WTTC or FLEXIBLE MOTOR SUPPLY CABLE 1000V 90°C Dry or MTW 600V or AWM 21179 90°C 1000V c(UL) CONTROL CABLE CIC/TC-ER DIR BUR SUN RES OIL RES I 600V 90°C Dry / 75°C Wet PVC SHIELDED FT4 or AWM VII A/B 90°C 1000V FT1 14 AWG – (prod.reference) = (metric) =

Dati tecnici - Technical data

Caratteristica - Characteristics	Valore/proprietà - Value/property
Conduttore Conductor	Trefolo flessibile in rame, classe 5 Flexible copper strand, class 5
Isolamento Insulation	TKblend®-R
Distinzione conduttori Conductor distinction	Neri numerati + giallo/verde (a partire dai 3 conduttori) Black numbered + yellow/green (beginning from 3 conductors)
Riempitivi Fillers	Eventuali riempitivi centrali o laterali Central or side fillers, if any
Schermatura Shield	Treccia di rame stagnato, ricopertura nom. 85% Tinned copper braid, nom. coverage 85%
Guaina Jacket	Mescola di PVC antioil, colore grigio RAL 7001. Marcatura metrica. PVC compound, oil-resistant, RAL 7001 gray color. Metric marking.
Temperatura di esercizio Temperature range	+90°C (dry conditions), +75°C (wet conditions) -40°C (posa fissa); -5°C (mobile) -40°C (fixed); -5°C (not fixed)
Tensione nominale Voltage rating	600 V (TC/CIC/MTW), 1000 V (AWM/WTTC), 600/1000 V (IEC)
Spark test	6000 V
Raggio di curvatura Bending radius	6 volte diametro esterno del cavo (20 volte diametro esterno del cavo per movimentazioni non continue) 6 x cable outer diameter (20 x cable outer diameter for non-cyclical mobile uses)
Riferimenti normativi costruttivi Standards of construction	UL/CSA approvals: (UL) Type TC-ER-HL* (18 AWG-1000 kcmil), MTW, WTTC, Dir Bur, Sun Res, Oil Res I, c(UL) Type CIC/TC-ER (18 AWG-4/0 AWG), Dir Bur, Sun Res, Oil Res I, cURus AWM Style 21179, AWM V II A/B; Class 1, Div.1* or Div.2 NEC Art. 336, 392, 501; CSA C22.1 Tab.19; UL 1581, UL 758, UL 1277, UL 1063, UL 2277, CSA C22.2 No.230-09 e No. 239-09 I Flame res.: FT1, FT4, IEC 60332-1-2, IEC 60332-3-24 I UV res.: UNI EN ISO 4892-3 (grigio/gray), UNI EN ISO 4892-2 (nero/black) I Other: Low Voltage Directive (LVD) 2014/35/EU
Riferimenti normativi d'impiego Standards of use	NFPA 79, NFPA 70 (NEC), CSA C22.1 (CE Code), CSA C22.2 No.286, Style 21179

Codifiche e dimensioni - Coding and dimensions

Codice Code	Numero di conduttori Number of conductors	Sezione Size [mm ²]	Sezione Size [AWG]	Diametro Diameter [mm]	Peso Weight [kg/km]
CV02X100_8110S_GR**	2	1	18	8,5	98
CV02X150_8110S_GR**	2	1,5	16	9,1	118
CV02X250_8110S_GR**	2	2,5	14	9,9	143
CV03G100_8110S_GR	3	1	18	8,9	120
CV03G150_8110S_GR	3	1,5	16	9,6	141
CV03G250_8110S_GR	3	2,5	14	10,4	181
CV03G400_8110S_GR	3	4	12	11,8	242
CV03G600_8110S_GR	3	6	10	13,9	354
CV04G100_8110S_GR	4	1	18	9,7	142

Cavi multipolari per posa fissa - Cables for fixed applications

Codice Code	Numero di conduttori Number of conductors	Sezione Size [mm ²]	Sezione Size [AWG]	Diametro Diameter [mm]	Peso Weight [kg/km]
CV04G150_8110S_GR	4	1,5	16	10,4	177
CV04G250_8110S_GR	4	2,5	14	11,3	228
CV04G400_8110S_GR	4	4	12	13,9	350
CV04G600_8110S_GR	4	6	10	15,2	450
CV04GB10_8110S_GR	4	10	8	19,3	718
CV04GB16_8110S_GR	4	16	6	24,7	1162
CV04GB25_8110S_GR	4	25	4	28,2	1616
CV04GB35_8110S_GR	4	35	2	31,1	2059
CV04GB50_8110S_GR	4	50	1	37,6	2938
CV04GB70_8110S_GR	4	70	2/0	44,2	4397
CV04GB95_8110S_GR	4	95	3/0	47,7	5566
CV04GL12_8110S_GR	4	120	4/0	50,3	6652
CV04GL15_8110S_GR	4	150	250	55,9	8250
CV04GL18_8110S_GR	4	185	350	60,0	8953
CV05G100_8110S_GR	5	1	18	10,5	171
CV05G150_8110S_GR	5	1,5	16	11,3	210
CV05G250_8110S_GR	5	2,5	14	12,4	273
CV05G400_8110S_GR	5	4	12	15,1	418
CV05G600_8110S_GR	5	6	10	16,6	539
CV05GB10_8110S_GR	5	10	8	22,3	917
CV05GB16_8110S_GR	5	16	6	27,1	1398
CV05GB25_8110S_GR	5	25	4	31,1	2059
CV07G100_8110S_GR	7	1	18	11,4	225
CV07G150_8110S_GR	7	1,5	16	12,3	278
CV07G250_8110S_GR	7	2,5	14	14,4	402
CV07G400_8110S_GR	7	4	12	16,4	557
CV09G150_8110S_GR	9	1,5	16	n.a.	n.a.
CV12G100_8110S_GR	12	1	18	15,5	365
CV12G150_8110S_GR	12	1,5	16	16,7	451
CV12G250_8110S_GR	12	2,5	14	18,3	593
CV18G100_8110S_GR	18	1	18	17,9	507
CV18G150_8110S_GR	18	1,5	16	19,4	632
CV18G250_8110S_GR	18	2,5	14	22,3	893
CV25G100_8110S_GR	25	1	18	20,3	638
CV25G150_8110S_GR	25	1,5	16	23,1	865

** In accordo a NFPA 70 (NEC) e CSA C22.1 (CEC) cavi con 2 conduttori non sono Exposed Run (ER).

** According to NFPA 70 (NEC) and CSA C22.1 (CEC) cables with 2 conductors are not Exposed Run (ER).

Composizione del codice - Code composition

CV □□ X □□□ _8110S_GR

Numero conduttori Number of conductors	Inserire To be inserted
2	02X
3, ..., 25	03G, ..., 25G

Sezione Size	Inserire To be inserted
1,00 mm ² , ..., 6,00 mm ²	100, ..., 600
10,0 mm ² , ..., 95,0 mm ²	B10, ..., B95
120 mm ² , ..., 185 mm ²	L12, ..., L18



Cavi multipolari per posa mobile

Cables for
dynamic applications

**SERIES
8410**

Power and Control Tray Cable, TC-ER-HL/CIC/MTW/WTTC/AWM

Direct Burial, Sun Res, Hazardous Locations



"UL Listed", posa mobile, non schermati - Dynamic application, unshielded



Impiego - Use

Cavi UL Listed non schermati costruiti per gli usi specificati dall'ANSI/NFPA 79, dagli articoli 336, 392, 501 del ANSI/NFPA 70 "National Electrical Code" (NEC) e dal CSA C22.1 (CE Code). Per applicazioni in Hazardous Locations, la versione TC-ER è idonea all'impiego in Class I, Division 2 mentre la versione TC-ER-HL* è idonea all'impiego in Class I, Division 1. I cavi TC-ER (Exposed Run) per impiego mobile sono adatti per installazioni in catene portacavi o su parti di macchine in movimento per distanze fino a 12 m. Possono inoltre essere installati negli impianti industriali per le connessioni tra le canaline posa cavi (cable tray) e l'apparecchiatura senza l'impiego di condotti metallici (metal conduits) o cavi armati Type MC (Metal Clad Cable); tale tipo di connessioni viene definito Open Wiring. Questi cavi sono oil resistant e sono adatti ad essere impiegati in ambienti interni con presenza di umidità. Questi cavi sono certificati anche Flexible Motor Supply Cable per azionamenti a velocità variabile e Wind Turbine Tray Cable (WTTC) per applicazioni eoliche.

Unshielded UL Listed cables built for the uses specified by ANSI/NFPA 79, by Art. 336, 392, 501 of ANSI/NFPA 70 "National Electrical Code" (NEC) and by CSA C22.1 (CE Code). For applications in Hazardous Locations, the TC-ER version is suitable for use in Class I, Division 2 while the TC-ER-HL version is suitable for use in Class I, Division 1. These TC-ER (Exposed Run) cables are used in power chains or moving machine parts for travel distances up to 12 m. They can be installed in the industrial plants for the connections between the cable trays and the equipment without the employment of metal conduits or reinforced cables Type MC (Metal Clad Cable); this type of connection is called Open Wiring. These cables are oil resistant and are suitable to be used in dry, damp and wet interiors. These cables are also certified Flexible Motor Supply Cable for variable speed drives and Wind Turbine Tray Cable (WTTC) for wind turbine applications.*

Informazione. Si effettua, su richiesta, un servizio aggiuntivo di taglio a misura certificato UL ("Processed Wire").

Information. An additional UL certified cut-to-length service is carried out on request ("Processed Wire").

* Importante. La versione TC-ER-HL per installazioni in Hazardous Locations Class I, Division 1 è su specifica richiesta.

* Important. The TC-ER-HL version for installations in Hazardous Locations Class I, Division 1 is upon specific request.

Dati tecnici - Technical data

Caratteristica - Characteristics	Valore/proprietà - Value/property
Conduttore <i>Conductor</i>	Trefolo flessibile in rame, classe 6 <i>Flexible copper strand, class 6</i>
Isolamento <i>Insulation</i>	TKblend®-R
Distinzione conduttori <i>Conductor distinction</i>	Neri numerati + giallo/verde (a partire dai 3 conduttori) <i>Black numbered + yellow/green (beginning from 3 conductors)</i>
Riempitivi <i>Fillers</i>	Eventuali riempitivi centrali o laterali <i>Central or side fillers, if any</i>
Nastratura <i>Taping</i>	Nastro di tessuto non tessuto <i>Nonwoven tape</i>
Guaina <i>Jacket</i>	Mescola di PVC antiolio, colore grigio RAL 7001. Marcatura metrica. <i>PVC compound, oil-resistant, RAL 7001 gray color. Metric marking.</i>
Temperatura di esercizio <i>Temperature range</i>	+90°C (dry conditions), +75°C (wet conditions) -40°C (posa fissa); -5°C (mobile) -40°C (fissa); -5°C (not fixed)
Tensione nominale <i>Voltage rating</i>	600 V (TC/CIC/MTW), 1000 V (AWM/WTTC), 600/1000 V (IEC)
Spark test	6000 V
Velocità <i>Speed</i>	180 m/min (catena autoportante/unsupported chain), 120 m/min (catena scorrimento/sliding chain)
Accelerazione <i>Acceleration</i>	10 m/s ² (≤10 mm ²), 5 m/s ² (>10 mm ²)
Raggio di curvatura <i>Bending radius</i>	7,5 volte diametro esterno del cavo (≤10 mm ²), 10 volte diametro esterno del cavo (>10 mm ²) <i>7,5 x cable outer diameter (≤10 mm²), 10 x cable outer diameter (>10 mm²)</i>
Riferimenti normativi costruttivi <i>Standards of construction</i>	UL/CSA approvals: (UL) Type TC-ER-HL (18 AWG-1000 kcmil), MTW, WTTC, Dir Bur, Sun Res, Oil Res I, c(UL) Type CIC/TC-ER (18 AWG-4/0 AWG), Dir Bur, Sun Res, Oil Res I, cURus AWM Style 21179, AWM I/II A/B; Class 1, Div.1* or Div.2 NEC Art. 336, 392, 501; CSA C22.1 Tab.19; UL 1581, UL 758, UL 1277, UL 1063, UL 2277, CSA C22.2 No.230-09 e No. 239-09 I Flame res.: FT1, FT4, IEC 60332-1-2, IEC 60332-3-24 I UV res.: UNI EN ISO 4892-3 (grigio/gray), UNI EN ISO 4892-2 (nero/black) I Other: Low Voltage Directive (LVD) 2014/35/EU
Riferimenti normativi d'impiego <i>Standards of use</i>	NFPA 79, NFPA 70 (NEC), CSA C22.1 (CE Code), CSA C22.2 No.286, Style 21179

Marcatura - Marking

TEKIMA 8410 – CE 4G2,5 mm² (UL) E361258 TC-ER-HL 4x14 AWG DIR BUR SUN RES OIL RES I 600V THHW 90°C Dry / 75°C Wet FT4/IEEE 1202 or WTTC or FLEXIBLE MOTOR SUPPLY CABLE 1000V 90°C Dry or MTW 600V or AWM 21179 90°C 1000V c(UL) CONTROL CABLE CIC/TC-ER DIR BUR SUN RES OIL RES I 600V 90°C Dry / 75°C Wet PVC FT4 or AWM I/II A/B 90°C 1000V FT1 14 AWG – (prod.reference) = (metric) =

Codifiche e dimensioni - Coding and dimensions

Codice <i>Code</i>	Numero di conduttori <i>Number of conductors</i>	Sezione Size [mm ²]	Sezione Size [AWG]	Diametro Diameter [mm]	Peso Weight [kg/km]
CV02X100_84100_GR**	2	1	18	8	90
CV02X150_84100_GR**	2	1,5	16	8,6	109

Cavi multipolari per posa mobile - Cables for dynamic applications

Codice Code	Numero di conduttori Number of conductors	Sezione Size [mm ²]	Sezione Size [AWG]	Diametro Diameter [mm]	Peso Weight [kg/km]
CV02X250_84100_GR**	2	2,5	14	9,4	141
CV03G100_84100_GR	3	1	18	8,7	111
CV03G150_84100_GR	3	1,5	16	9,4	136
CV03G250_84100_GR	3	2,5	14	10,3	179
CV03G400_84100_GR	3	4	12	11,7	247
CV03G600_84100_GR	3	6	10	13,9	358
CV04G100_84100_GR	4	1	18	9,4	133
CV04G150_84100_GR	4	1,5	16	10,1	163
CV04G250_84100_GR	4	2,5	14	11,1	217
CV04G400_84100_GR	4	4	12	12,7	304
CV04G600_84100_GR	4	6	10	15	438
CV04GB10_84100_GR	4	10	8	19,3	727
CV04GB16_84100_GR	4	16	6	24,9	1185
CV04GB25_84100_GR	4	25	4	27,8	1465
CV04GB35_84100_GR	4	35	2	32,3	1465
CV05G100_84100_GR	5	1	18	10,3	161
CV05G150_84100_GR	5	1,5	16	11,1	199
CV05G250_84100_GR	5	2,5	14	12,2	265
CV05G400_84100_GR	5	4	12	14,7	398
CV05G600_84100_GR	5	6	10	16,5	537
CV05GB10_84100_GR	5	10	8	22,5	951
CV05GB16_84100_GR	5	16	6	27,6	1465
CV07G100_84100_GR	7	1	18	12,1	223
CV07G150_84100_GR	7	1,5	16	13,1	277
CV07G250_84100_GR	7	2,5	14	15,2	400
CV07G400_84100_GR	7	4	12	17,8	574
CV08G100_84100_GR	8	1	18	13	256
CV08G150_84100_GR	8	1,5	16	14,8	346
CV08G250_84100_GR	8	2,5	14	16,3	459
CV12G100_84100_GR	12	1	18	15,1	355
CV12G150_84100_GR	12	1,5	16	16,4	446
CV12G250_84100_GR	12	2,5	14	18,1	603
CV18G100_84100_GR	18	1	18	17,6	494
CV18G150_84100_GR	18	1,5	16	19,2	627
CV25G100_84100_GR	25	1	18	20,8	696
CV25G150_84100_GR	25	1,5	16	23,8	938

** In accordo a NFPA 70 (NEC) e CSA C22.1 (CEC) cavi con 2 conduttori non sono Exposed Run (ER).

** According to NFPA 70 (NEC) and CSA C22.1 (CEC) cables with 2 conductors are not Exposed Run (ER).

Composizione del codice - Code composition

CV □□ X □□□ _84100_GR

Numero conduttori Number of conductors	Inserire To be inserted
2	02X
3, ..., 25	03G, ..., 25G

Sezione Size	Inserire To be inserted
1,00 mm ² , ..., 6,00 mm ²	100, ..., 600
10,0 mm ² , ..., 35,0 mm ²	B10, ..., B35

**SERIES
8410S**

Power and Control Tray Cable, TC-ER-HL/CIC/MTW/WTTC/AWM Direct Burial, Sun Res, Hazardous Locations



“UL Listed”, posa mobile, schermati - Dynamic application, shielded

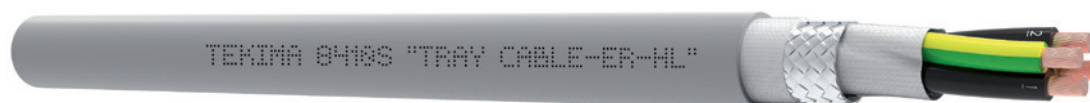

Impiego - Use

Cavi UL Listed schermati costruiti per gli usi specificati dall'ANSI/NFPA 79, dagli articoli 336, 392, 501 del ANSI/NFPA 70 “National Electrical Code” (NEC) e dal CSA C22.1 (CE Code). Per applicazioni in Hazardous Locations, la versione TC-ER è idonea all'impiego in Class I, Division 2 mentre la versione TC-ER-HL* è idonea all'impiego in Class I, Division 1. I cavi TC-ER (Exposed Run) per impiego mobile sono adatti per installazioni in catene portacavi o su parti di macchine in movimento per distanze fino a 12 m. Possono inoltre essere installati negli impianti industriali per le connessioni tra le canaline posa cavi (cable tray) e l'apparecchiatura senza l'impiego di condotti metallici (metal conduits) o cavi armati Type MC (Metal Clad Cable); tale tipo di connessioni viene definito Open Wiring. Questi cavi sono oil resistant e sono adatti ad essere impiegati in ambienti interni con presenza di umidità. Questi cavi sono certificati anche Flexible Motor Supply Cable per azionamenti a velocità variabile e Wind Turbine Tray Cable (WTTC) per applicazioni eoliche.

Shielded UL Listed cables built for the uses specified by ANSI/NFPA 79, by Art. 336, 392, 501 of ANSI/NFPA 70 “National Electrical Code” (NEC) and by CSA C22.1 (CE Code). For applications in Hazardous Locations, the TC-ER version is suitable for use in Class I, Division 2 while the TC-ER-HL version is suitable for use in Class I, Division 1. These TC-ER (Exposed Run) cables are used in power chains or moving machine parts for travel distances up to 12 m. They can be installed in the industrial plants for the connections between the cable trays and the equipment without the employment of metal conduits or reinforced cables MC type (Metal Clad Cable); this type of connection is called Open Wiring. These cables are oil resistant and are suitable to be used in dry, damp and wet interiors. These cables are also certified Flexible Motor Supply Cable for variable speed drives and Wind Turbine Tray Cable (WTTC) for wind turbine applications.*

Informazione. Si effettua, su richiesta, un servizio aggiuntivo di taglio a misura certificato UL (“Processed Wire”).

Information. An additional UL certified cut-to-length service is carried out on request (“Processed Wire”).

* Importante. La versione TC-ER-HL per installazioni in Hazardous Locations Class I, Division 1 è su specifica richiesta.

** Important. The TC-ER-HL version for installations in Hazardous Locations Class I, Division 1 is upon specific request.*

Dati tecnici - Technical data

Caratteristica - Characteristics	Valore/proprietà - Value/property
Conduttore <i>Conductor</i>	Trefolo flessibile in rame, classe 6 <i>Flexible copper strand, class 6</i>
Isolamento <i>Insulation</i>	TKblend®-R
Distinzione conduttori <i>Conductor distinction</i>	Neri numerati + giallo/verde (a partire dai 3 conduttori) <i>Black numbered + yellow/green (beginning from 3 conductors)</i>
Riempitivi <i>Fillers</i>	Eventuali riempitivi centrali o laterali <i>Central or side fillers, if any</i>
Nastratura interna <i>Inner taping</i>	Nastro di tessuto non tessuto <i>Nonwoven tape</i>
Schermatura <i>Shield</i>	Treccia di rame stagnato, ricopertura nom. 85% <i>Tinned copper braid, nom. coverage 85%</i>
Nastratura esterna <i>Outer taping</i>	Nastro di tessuto non tessuto <i>Nonwoven tape</i>
Guaina <i>Jacket</i>	Miscela di PVC antiolio, colore grigio RAL 7001. Marcatura metrica. <i>PVC compound, oil-resistant, RAL 7001 gray color. Metric marking.</i>
Temperatura di esercizio <i>Temperature range</i>	+90°C (dry conditions), +75°C (wet conditions) -40°C (posa fissa); -5°C (mobile) -40°C (fixed); -5°C (not fixed)
Tensione nominale <i>Voltage rating</i>	600 V (TC/CIC/MTW), 1000 V (AWM/WTTC), 600/1000 V (IEC)
Spark test	6000 V
Velocità <i>Speed</i>	180 m/min (catena autoportante/ <i>unsupported chain</i>), 120 m/min (catena scorrimento/ <i>sliding chain</i>)
Accelerazione <i>Acceleration</i>	10 m/s ² (≤10 mm ²), 5 m/s ² (>10 mm ²)
Raggio di curvatura <i>Bending radius</i>	7,5 volte diametro esterno del cavo (≤10 mm ²), 10 volte diametro esterno del cavo (>10 mm ²) <i>7,5 x cable outer diameter (≤10 mm²), 10 x cable outer diameter (>10 mm²)</i>
Riferimenti normativi costruttivi <i>Standards of construction</i>	UL/CSA approvals: (UL) Type TC-ER-HL (18 AWG-1000 kcmil), MTW, WTTC, Dir Bur, Sun Res, Oil Res I, c(UL) Type CIC/TC-ER (18 AWG-4/0 AWG), Dir Bur, Sun Res, Oil Res I, cURus AWM Style 21179, AWM I/II A/B; Class 1, Div.1* or Div.2 NEC Art. 336, 392, 501; CSA C22.1 Tab.19; UL 1581, UL 758, UL 1277, UL 1063, UL 2277, CSA C22.2 No.230-09 e No. 239-09 I Flame res.: FT1, FT4, IEC 60332-1-2, IEC 60332-3-24 I UV res.: UNI EN ISO 4892-3 (grigio/gray), UNI EN ISO 4892-2 (nero/black) I Other: Low Voltage Directive (LVD) 2014/35/EU
Riferimenti normativi d'impiego <i>Standards of use</i>	NFPA 79, NFPA 70 (NEC), CSA C22.1 (CE Code), CSA C22.2 No.286, Style 21179

Marcatura - Marking

TEKIMA 8410S – CE 4G2,5 mm² (UL) E361258 TC-ER-HL 4x14 AWG DIR BUR SUN RES OIL RES I 600V THHW 90°C Dry / 75°C Wet FT4/IEEE 1202 or WTTC or FLEXIBLE MOTOR SUPPLY CABLE 1000V 90°C Dry or MTW 600V or AWM 21179 90°C 1000V c(UL) CONTROL CABLE CIC/TC-ER DIR BUR SUN RES OIL RES I 600V 90°C Dry / 75°C Wet PVC SHIELDED FT4 or AWM I/II A/B 90°C 1000V FT1 14 AWG – (prod.reference) = (metric) =

Codifiche e dimensioni - Coding and dimensions

Codice <i>Code</i>	Numero di conduttori <i>Number of conductors</i>	Sezione <i>Size [mm²]</i>	Sezione <i>Size [AWG]</i>	Diametro <i>Diameter [mm]</i>	Peso <i>Weight [kg/km]</i>
CV02X100_8410S_GR**	2	1	18	8,6	103
CV02X150_8410S_GR**	2	1,5	16	9,2	119
CV02X250_8410S_GR**	2	2,5	14	10	149
CV03G100_8410S_GR	3	1	18	9,3	121
CV03G150_8410S_GR	3	1,5	16	10	147
CV03G250_8410S_GR	3	2,5	14	10,9	189
CV03G400_8410S_GR	3	4	12	12,3	250
CV03G600_8410S_GR	3	6	10	14,7	372
CV04G100_8410S_GR	4	1	18	10	148
CV04G150_8410S_GR	4	1,5	16	10,7	182
CV04G250_8410S_GR	4	2,5	14	11,7	235
CV04G400_8410S_GR	4	4	12	13,5	335
CV04G600_8410S_GR	4	6	10	15,8	470
CV04GB10_8410S_GR	4	10	8	20,1	736
CV04GB16_8410S_GR	4	16	6	25,7	1169
CV04GB25_8410S_GR	4	25	4	28,6	1580
CV04GB35_8410S_GR	4	35	2	33,3	2167
CV05G100_8410S_GR	5	1	18	10,9	176
CV05G150_8410S_GR	5	1,5	16	11,7	214
CV05G250_8410S_GR	5	2,5	14	12,8	273
CV05G400_8410S_GR	5	4	12	15,5	417
CV05G600_8410S_GR	5	6	10	17,3	557
CV05GB10_8410S_GR	5	10	8	23,3	941
CV05GB16_8410S_GR	5	16	6	28,4	1402
CV07G100_8410S_GR	7	1	18	12,7	230
CV07G150_8410S_GR	7	1,5	16	13,9	300
CV07G250_8410S_GR	7	2,5	14	16	421
CV08G100_8410S_GR	8	1	18	13,8	279
CV08G150_8410S_GR	8	1,5	16	15,6	369
CV08G250_8410S_GR	8	2,5	14	17,1	477
CV12G100_8410S_GR	12	1	18	15,9	380
CV12G150_8410S_GR	12	1,5	16	17,2	467
CV12G250_8410S_GR	12	2,5	14	18,9	614
CV18G100_8410S_GR	18	1	18	18,4	513
CV18G150_8410S_GR	18	1,5	16	20	636
CV25G100_8410S_GR	25	1	18	21,6	676
CV25G150_8410S_GR	25	1,5	16	24,6	908

** In accordo a NFPA 70 (NEC) e CSA C22.1 (CEC) cavi con 2 conduttori non sono Exposed Run (ER).

** According to NFPA 70 (NEC) and CSA C22.1 (CEC) cables with 2 conductors are not Exposed Run (ER).

Composizione del codice - Code composition

CV □□ X □□□ _8410S_GR

Numero conduttori <i>Number of conductors</i>	Inserire <i>To be inserted</i>
2	02X
3, ..., 25	03G, ..., 25G

Sezione <i>Size</i>	Inserire <i>To be inserted</i>
1,00 mm ² , ..., 6,00 mm ²	100, ..., 600
10,0 mm ² , ..., 35,0 mm ²	B10, ..., B35

**SERIES
400S**

Cavi multipolari multinorma antiolio per servomotori



Multi-norm oil-resistant cables for servo motors

Posa mobile, schermati - Dynamic application, shielded



Impiego - Use

Cavi schermati per impiego mobile privo di sollecitazioni di trazione. Vengono normalmente utilizzati per l'equipaggiamento di apparecchiature destinate sia al mercato Europeo (CE) che ai mercati nord americani e canadesi. La guaina realizzata con mescola di PVC garantisce una buona flessibilità ed una ottima resistenza all'abrasione; questi cavi sono resistenti agli olii ed ai fluidi industriali più utilizzati. La marcatura metrica stampigliata sulla guaina del cavo ne favorisce la lavorazione e l'installazione.

Shielded cables for mobile use without tensile stress. They are normally used for equipments meant for the European (EC), North American and Canadian markets. The jacket, made of PVC compound, grants a good flexibility and a very good resistance to abrasion; these cables exhibit a resistance to the most common industrial oils and fluids. The metric marked on the jacket allows an easier processing and installation of the cable.

Informazione. Si effettua, su richiesta, un servizio aggiuntivo di taglio a misura certificato UL ("Processed Wire").

Information. An additional UL certified cut-to-length service is carried out on request ("Processed Wire").

Dati tecnici - Technical data

Caratteristica - Characteristics	Valore/proprietà - Value/property
Conduttore <i>Conductor</i>	Trefolo flessibile in rame, classe 5 <i>Flexible copper strand, class 5</i>
Isolamento <i>Insulation</i>	TKblend®-YP
Distinzione conduttori <i>Conductor distinction</i>	Potenza: neri numerati + giallo/verde. Segnale: neri numerati <i>Power: black numbered + yellow/green. Signal: black numbered</i>
Riempitivi <i>Fillers</i>	Eventuali riempitivi centrali o laterali <i>Central or side fillers, if any</i>
Schermatura coppie <i>Pairs shield</i>	Alluminio/poliestere e treccia di rame stagnato con ricopertura nom. 85% <i>Aluminum/polyester and tinned copper braid, nom. coverage 85%</i>
Nastratura coppie <i>Pairs taping</i>	Poliestere <i>Polyester</i>
Nastratura totale <i>Total taping</i>	Poliestere <i>Polyester</i>
Schermatura <i>Shield</i>	Treccia di rame stagnato con ricopertura nom. 85% <i>Tinned copper braid, nom. coverage 85%</i>
Guaina <i>Jacket</i>	Mescola di PVC antiolio, colore arancione Desina RAL 2003. Marcatura metrica. <i>PVC compound, oil-resistant, Desina RAL 2003 orange color. Metric marking.</i>
Temperatura di esercizio <i>Temperature range</i>	-5°C, +80°C (posa mobile); -40°C, +80°C (posa fissa) <i>-5°C, +80°C (dynamic); -40°C, +80°C (fixed)</i>
Tensione nominale <i>Voltage rating</i>	1000 V (UL-CSA), 600/1000 V (IEC)
Tensione di prova <i>Test voltage</i>	6000 V
Velocità <i>Speed</i>	180 m/min
Accelerazione <i>Acceleration</i>	3 m/s ²
Raggio di curvatura <i>Bending radius</i>	7 volte diametro esterno del cavo (posa fissa), 20 volte diametro esterno del cavo (posa mobile) <i>7 x cable outer diameter (fixed), 20 x cable outer diameter (dynamic)</i>
Riferimenti normativi costruttivi <i>Standards of construction</i>	Flame res.: IEC 60332-1-2, IEC 60332-3-24, DIN VDE 0472 part 804 Meth.B, UL VW-1, CSA FT1 I Oil res.: DIN EN 50290-2-22 resp. VDE 0819-102 I Other: UL 758, CSA AWM I/II A/B, cURus AWM Style 2570, Low Voltage Directive (LVD) 2014/35/EC
Riferimenti normativi d'impiego <i>Standards of use</i>	ANSI/NFPA 79, UL 508a, CSA C22.1 (CE Code), CSA C22.2 No.286, Style 2570

Marcatura - Marking

TEKIMA 0400S - CE (4G1,5+(2x1)) mm² 80°C 600/1000 V IEC 60332-1-2 IEC 60332-3-24 - c(UR)us E314444 AWM Style 2570 (4x18+(2x16)) AWG 80°C 1000 V VW-1 Class I/II A/B FT1 - (prod.reference) = (metric) =

Codifiche e dimensioni - Coding and dimensions

Codice <i>Code</i>	N° conduttori x sezione <i>Num. conductors x Size [mm²]</i>	N° conduttori x sezione <i>Num. conductors x Size [AWG/kcmil]</i>	Diametro <i>Diameter [mm]</i>	Peso <i>Weight [kg/km]</i>
CVFM0002_0400S_D2	(4G1,5+(2x0,5))	(4x18+(2x21))	10,0	125
CVFM0003_0400S_D2	(4G1,5+(2x0,5))	(4x16+(2x21))	10,7	149
CVFM0004_0400S_D2	(4G1,5+(2x1))	(4x16+(2x18))	11,3	157

Cavi multipolari per posa mobile - Cables for dynamic applications

Codice Code	N° conduttori x sezione Num. conductors x Size [mm ²]	N° conduttori x sezione Num. conductors x Size [AWG/kcmil]	Diametro Diameter [mm]	Peso Weight [kg/km]
CVFM0005_0400S_D2	(4G1,5+(2x1,5))	(4x16+(2x16))	11,5	154
CVFM0006_0400S_D2	(4G1,5)	(4x16)	8,8	120
CVFM0007_0400S_D2	(4G2,5+(2x0,5))	(4x14+(2x21))	11,6	198
CVFM0008_0400S_D2	(4G2,5+(2x0,75))	(4x14+(2x19))	11,9	204
CVFM0009_0400S_D2	(4G2,5+(2x1))	(4x14+(2x18))	12,3	206
CVFM0010_0400S_D2	(4G2,5+(2x1,5))	(4x14+(2x16))	12,7	209
CVFM0011_0400S_D2	(4G2,5)	(4x14)	10,1	179
CVFM0012_0400S_D2	(4G4+(2x1))	(4x12+(2x18))	14,0	302
CVFM0013_0400S_D2	(4G4+(2x1,5))	(4x12+(2x16))	14,4	302
CVFM0014_0400S_D2	(4G4)	(4x12)	11,7	256
CVFM0015_0400S_D2	(4G6+(2x1))	(4x10+(2x18))	15,7	403
CVFM0016_0400S_D2	(4G6+(2x1,5))	(4x10+(2x16))	16,3	415
CVFM0017_0400S_D2	(4G6)	(4x10)	13,5	354
CVFM0018_0400S_D2	(4G10+(2x1))	(4x8+(2x18))	18,2	592
CVFM0019_0400S_D2	(4G10+(2x1,5))	(4x8+(2x16))	18,7	602
CVFM0020_0400S_D2	(4G10)	(4x8)	16,5	568
CVFM0021_0400S_D2	(4G16+(2x1))	(4x6+(2x18))	21,5	876
CVFM0022_0400S_D2	(4G16+(2x1,5))	(4x6+(2x16))	22,0	890
CVFM0023_0400S_D2	(4G16)	(4x6)	20,2	867
CVFM0024_0400S_D2	(4G25+(2x1,5))	(4x4+(2x16))	26,0	1307
CVFM0025_0400S_D2	(4G25)	(4x4)	24,7	1309
CVFM0026_0400S_D2	(4G35+(2x1,5))	(4x2+(2x16))	29,3	1749
CVFM0027_0400S_D2	(4G35)	(4x2)	27,9	1738
CVFM0028_0400S_D2	(4G50+(2x1,5))	(4x1+(2x16))	34,2	2489
CVFM0029_0400S_D2	(4G50)	(4x1)	33,4	2499
CVFM0030_0400S_D2	(4G70)	(4x2/0)	39,7	3453
CVFM0031_0400S_D2	(4G95)	(4x3/0)	43,8	4486
CVFM0032_0400S_D2	(4G120)	(4x4/0)	46,8	5430
CVFM0033_0400S_D2	(4G150)	(4x250)	52,4	6925

Composizione del codice - Code composition

CVFM □□□□ _0400S_ □□

Formazione
Construction

Codice identificativo della particolare formazione del cavo.
Identifier code of the cable construction.

Colore

Color

Arancione Desina

Orange Desina

Inserire

To be inserted

D2

SERIES
410

Cavi multipolari multinorma antiolio

Multi-norm oil-resistant cables



Posa mobile, non schermati - Dynamic application, unshielded



UL US

RoHS

CE UK

Impiego - Use

Cavi non schermati per impiego mobile in catene portacavi o su parti di macchine in movimento per distanze fino a 10 m. Vengono normalmente utilizzati per l'equipaggiamento di apparecchiature destinate sia al mercato Europeo (CE) che ai mercati nord americani e canadesi. La guaina realizzata con miscela di PVC garantisce una buona flessibilità ed una ottima resistenza all'abrasione. La marcatura metrica stampigliata sulla guaina del cavo ne favorisce la lavorazione e l'installazione.

Unshielded cables for mobile use in power chains or moving machine parts for travel distances up to 10 m. They are normally used for equipment intended for the European (EC), North American and Canadian markets. The jacket, made of PVC compound, grants a good flexibility and a very good resistance to abrasion. The metric marked on the jacket allows an easier processing and installation of the cable.

Informazione. Si effettua, su richiesta, un servizio aggiuntivo di taglio a misura certificato UL ("Processed Wire").

Information. An additional UL certified cut-to-length service is carried out on request ("Processed Wire").

Dati tecnici - Technical data

Caratteristica - Characteristics	Valore/proprietà - Value/property
Conduttore <i>Conductor</i>	Trefolo flessibile in rame, classe 5 <i>Flexible copper strand, class 5</i>
Isolamento <i>Insulation</i>	PVC
Distinzione conduttori <i>Conductor distinction</i>	Neri numerati + giallo/verde (a partire dai 3 conduttori) <i>Black numbered + yellow/green (beginning from 3 conductors)</i>
Riempitivi <i>Fillers</i>	Eventuali riempitivi centrali o laterali <i>Central or side fillers, if any</i>
Nastratura <i>Taping</i>	Nastro di tessuto-non-tessuto <i>Non-woven tape</i>
Guaina <i>Jacket</i>	Miscela di PVC antiolio, colore grigio RAL 7001. Marcatura metrica. <i>PVC compound, oil-resistant, RAL 7001 gray color. Metric marking.</i>
Temperatura di esercizio <i>Temperature range</i>	-0°C, +90°C (posa mobile); -40°C, +90°C (posa fissa) <i>-0°C, +90°C (dynamic); -40°C, +90°C (fixed)</i>
Tensione nominale <i>Voltage rating</i>	300/500 V (IEC), 600 V (UL-CSA)
Tensione di prova <i>Test voltage</i>	6000 V
Velocità <i>Speed</i>	180 m/min
Accelerazione <i>Acceleration</i>	3 m/s ²
Raggio di curvatura <i>Bending radius</i>	4 volte diametro esterno del cavo (posa fissa) 12 volte diametro esterno del cavo (posa mobile) <i>4 x cable outer diameter (fixed)</i> <i>12 x cable outer diameter (dynamic)</i>
Riferimenti normativi costruttivi <i>Standards of construction</i>	Flame res.: IEC 60332-1-2, IEC 60332-3-24 Cat.C, DIN VDE 0472 part 804 B, UL VW-1, CSA FT1 Oil res.: EN 50290-2-22 TM54 UV res.: UNI EN ISO 4892-3 (grigio/gray), UNI EN ISO 4892-2 (nero/black) Other: UL 758, CSA AWM I/II A/B, cURus AWM Style 2587, Low Voltage Directive (LVD) 2006/95/EC
Riferimenti normativi d'impiego <i>Standards of use</i>	ANSI/NFPA 79, UL 508a, CSA C22.1 (CE Code), CSA C22.2 No.286, Style 2587

Marcatura - Marking

TEKIMA 04100 – CE 4G1,5 mm² 90°C 300/500 V IEC 60332-1-2 IEC 60332-3-24 Cat.C – c(UR)us E314444 AWM Style 2587 4x16 AWG 90°C 600 V VW-1 AWM Class I/II A/B FT1 – (prod.reference) = (metric) =

Codifiche e dimensioni - Coding and dimensions

Codice <i>Code</i>	Numero di conduttori <i>Number of conductors</i>	Sezione <i>Size [mm²]</i>	Sezione <i>Size [AWG]</i>	Diametro <i>Diameter [mm]</i>	Peso <i>Weight [kg/km]</i>
CV02X050_04100_□□	2	0,5	21	5,2	40
CV02X075_04100_□□	2	0,75	19	5,6	48
CV02X100_04100_□□	2	1	18	6,0	57
CV02X150_04100_□□	2	1,5	16	6,5	72
CV03G050_04100_□□	3	0,5	21	5,7	50
CV03G075_04100_□□	3	0,75	19	6,1	61
CV03G100_04100_□□	3	1	18	6,6	73

Cavi multipolari per posa mobile - Cables for dynamic applications

Codice Code	Numero di conduttori Number of conductors	Sezione Size [mm ²]	Sezione Size [AWG]	Diametro Diameter [mm]	Peso Weight [kg/km]
CV03G150_04100_□□	3	1,5	16	7,1	92
CV03G250_04100_□□	3	2,5	14	8,8	146
CV03G400_04100_□□	3	4	12	10,3	211
CV03G600_04100_□□	3	6	10	12,1	301
CV04G050_04100_□□	4	0,5	21	6,3	62
CV04G075_04100_□□	4	0,75	19	6,8	77
CV04G100_04100_□□	4	1	18	7,3	92
CV04G150_04100_□□	4	1,5	16	7,9	117
CV04G250_04100_□□	4	2,5	14	10,0	191
CV04G400_04100_□□	4	4	12	11,7	275
CV04G600_04100_□□	4	6	10	13,7	393
CV04GB10_04100_□□	4	10	8	17,6	680
CV04GB16_04100_□□	4	16	6	20,8	1001
CV05G050_04100_□□	5	0,5	21	6,8	73
CV05G075_04100_□□	5	0,75	19	7,4	92
CV05G100_04100_□□	5	1	18	8,2	116
CV05G150_04100_□□	5	1,5	16	8,9	147
CV05G250_04100_□□	5	2,5	14	11,2	239
CV05G400_04100_□□	5	4	12	13,1	344
CV05G600_04100_□□	5	6	10	15,5	497
CV05GB10_04100_□□	5	10	8	19,8	847
CV05GB16_04100_□□	5	16	6	23,3	1254
CV07G050_04100_□□	7	0,5	21	8,2	105
CV07G075_04100_□□	7	0,75	19	8,9	131
CV07G100_04100_□□	7	1	18	9,8	146
CV07G150_04100_□□	7	1,5	16	10,7	210
CV07G250_04100_□□	7	2,5	14	13,4	338
CV12G050_04100_□□	12	0,5	21	9,2	143
CV12G075_04100_□□	12	0,75	19	10,2	187
CV12G100_04100_□□	12	1	18	11,2	234
CV12G150_04100_□□	12	1,5	16	12,2	303
CV12G250_04100_□□	12	2,5	14	15,5	499
CV18G050_04100_□□	18	0,5	21	11,6	223
CV18G075_04100_□□	18	0,75	19	12,9	293
CV18G100_04100_□□	18	1	18	14,1	363
CV18G150_04100_□□	18	1,5	16	15,6	478
CV25G050_04100_□□	25	0,5	21	13,5	307
CV25G075_04100_□□	25	0,75	19	14,9	399
CV25G100_04100_□□	25	1	18	16,4	499
CV25G150_04100_□□	25	1,5	16	18,3	666

Composizione del codice - Code composition

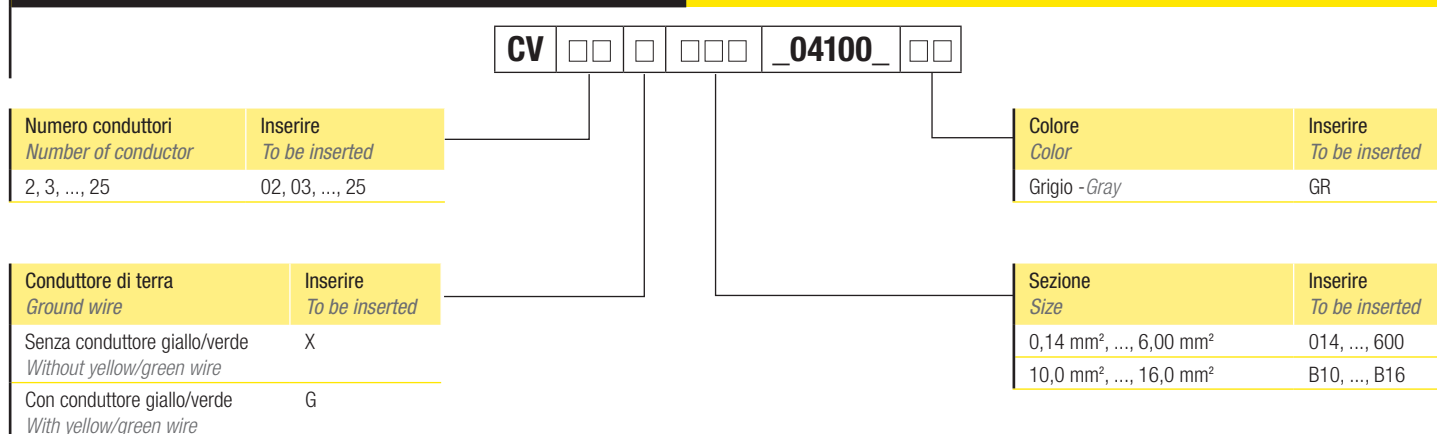

**SERIES
410S**

Cavi multipolari multinorma antiolio

Multi-norm oil-resistant cables

Posa mobile, schermati - Dynamic application, shielded



cURus

RoHS

CE UK

Impiego - Use

Cavi schermati per impiego mobile in catene portacavi o su parti di macchine in movimento per distanze fino a 10 m. Vengono normalmente utilizzati per l'equipaggiamento di apparecchiature destinate sia al mercato Europeo (CE) che ai mercati nord americani e canadesi. La guaina realizzata con mescola di PVC garantisce una buona flessibilità ed una ottima resistenza all'abrasione. La marcatura metrica stampigliata sulla guaina del cavo ne favorisce la lavorazione e l'installazione.

Shielded cables for mobile use in power chains or moving machine parts for travel distances up to 10 m. They are normally used for equipment intended for the European (EC), North American and Canadian markets. The jacket, made of PVC compound, grants a good flexibility and a very good resistance to abrasion. The metric marked on the jacket allows an easier processing and installation of the cable.

Informazione. Si effettua, su richiesta, un servizio aggiuntivo di taglio a misura certificato UL ("Processed Wire").

Information. An additional UL certified cut-to-length service is carried out on request ("Processed Wire").

Dati tecnici - Technical data

Caratteristica - Characteristics	Valore/proprietà - Value/property
Conduttore <i>Conductor</i>	Trefolo flessibile in rame, classe 5 <i>Flexible copper strand, class 5</i>
Isolamento <i>Insulation</i>	PVC
Distinzione conduttori <i>Conductor distinction</i>	Neri numerati + giallo/verde (a partire dai 3 conduttori) <i>Black numbered + yellow/green (beginning from 3 conductors)</i>
Riempitivi <i>Fillers</i>	Eventuali riempitivi centrali o laterali <i>Central or side fillers, if any</i>
Nastratura interna <i>Inner Taping</i>	Nastro di tessuto-non-tessuto e nastro poliestere <i>Non-woven tape and polyester tape</i>
Schermatura <i>Shield</i>	Treccia di rame stagnato, ricopertura nom. 80% <i>Tinned copper braid, nom. coverage 80%</i>
Nastratura esterna <i>Outer Taping</i>	Nastro di tessuto-non-tessuto <i>Non-woven tape</i>
Guaina <i>Jacket</i>	Mescola di PVC antiolio, colore grigio RAL 7001. M Marcatura metrica. <i>PVC compound, oil-resistant, RAL 7001 gray color. Metric marking.</i>
Temperatura di esercizio <i>Temperature range</i>	-0°C, +90°C (posa mobile); -40°C, +90°C (posa fissa) <i>-0°C, +90°C (dynamic); -40°C, +90°C (fixed)</i>
Tensione nominale <i>Voltage rating</i>	300/500 V (IEC), 600 V (UL-CSA)
Tensione di prova <i>Test voltage</i>	6000 V
Velocità <i>Speed</i>	180 m/min
Accelerazione <i>Acceleration</i>	3 m/s ²
Raggio di curvatura <i>Bending radius</i>	4 volte diametro esterno del cavo (posa fissa) 12 volte diametro esterno del cavo (posa mobile) <i>4 x cable outer diameter (fixed) 12 x cable outer diameter (dynamic)</i>
Riferimenti normativi costruttivi <i>Standards of construction</i>	Flame res.: IEC 60332-1-2, IEC 60332-3-24 Cat.C, DIN VDE 0472 part 804 B, UL VW-1, CSA FT1 Oil res.: EN 50290-2-22 TM54 UV res.: UNI EN ISO 4892-3 (grigio/gray), UNI EN ISO 4892-2 (nero/black) Other: UL 758, CSA AWM I/II A/B, cURus AWM Style 2587, Low Voltage Directive (LVD) 2006/95/EC
Riferimenti normativi d'impiego <i>Standards of use</i>	ANSI/NFPA 79, UL 508a, CSA C22.1 (CE Code), CSA C22.2 No.286, Style 2587

Marcatura - Marking

TEKIMA 0410S – CE 4G1,5 mm² 90°C 300/500 V IEC 60332-1-2 IEC 60332-3-24 Cat.C – c(UR)us E31444 AWM Style 2587 4x16 AWG 90°C 600 V VW-1 AWM Class I/II A/B FT1 – (prod.reference) = (metric) =

Codifiche e dimensioni - Coding and dimensions

Codice <i>Code</i>	Numero di conduttori <i>Number of conductors</i>	Sezione <i>Size [mm²]</i>	Sezione <i>Size [AWG]</i>	Diametro <i>Diameter [mm]</i>	Peso <i>Weight [kg/km]</i>
CV02X050_0410S_□□	2	0,5	21	6,8	75,6
CV02X075_0410S_□□	2	0,75	19	7,2	85,6
CV02X100_0410S_□□	2	1	18	7,6	100,6

Cavi multipolari per posa mobile - Cables for dynamic applications

Codice Code	Numero di conduttori Number of conductors	Sezione Size [mm ²]	Sezione Size [AWG]	Diametro Diameter [mm]	Peso Weight [kg/km]
CV02X150_0410S_□□	2	1,5	16	8,3	120,0
CV03G050_0410S_□□	3	0,5	21	7,3	87,0
CV03G075_0410S_□□	3	0,75	19	7,7	104,1
CV03G100_0410S_□□	3	1	18	8,4	122,0
CV03G150_0410S_□□	3	1,5	16	9,1	151,2
CV03G250_0410S_□□	3	2,5	14	11,0	221,3
CV04G050_0410S_□□	4	0,5	21	8,1	109,5
CV04G075_0410S_□□	4	0,75	19	8,8	129,6
CV04G100_0410S_□□	4	1	18	9,5	156,1
CV04G150_0410S_□□	4	1,5	16	10,1	183,3
CV04G250_0410S_□□	4	2,5	14	12,0	270,2
CV04G400_0410S_□□	4	4	12	14,1	390,9
CV04G600_0410S_□□	4	6	10	16,3	532,8
CV04GB10_0410S_□□	4	10	8	21,1	878,5
CV04GB16_0410S_□□	4	16	6	24,5	1.259,1
CV05G050_0410S_□□	5	0,5	21	8,8	126,1
CV05G075_0410S_□□	5	0,75	19	9,6	156,7
CV05G100_0410S_□□	5	1	18	10,2	178,6
CV05G150_0410S_□□	5	1,5	16	11,1	222,8
CV05G250_0410S_□□	5	2,5	14	13,4	346,5
CV05G400_0410S_□□	5	4	12	15,7	482,2
CV05G600_0410S_□□	5	6	10	17,9	647,0
CV07G050_0410S_□□	7	0,5	21	10,2	168,0
CV07G075_0410S_□□	7	0,75	19	11,1	207,0
CV07G100_0410S_□□	7	1	18	11,8	242,4
CV07G150_0410S_□□	7	1,5	16	12,9	298,0
CV07G250_0410S_□□	7	2,5	14	16,0	477,3
CV12G050_0410S_□□	12	0,5	21	11,4	219,8
CV12G075_0410S_□□	12	0,75	19	12,4	273,3
CV12G100_0410S_□□	12	1	18	13,4	341,7
CV12G150_0410S_□□	12	1,5	16	14,6	420,9
CV18G050_0410S_□□	18	0,5	21	14,0	339,0
CV18G075_0410S_□□	18	0,75	19	15,5	429,8
CV18G100_0410S_□□	18	1	18	16,5	497,4
CV18G150_0410S_□□	18	1,5	16	18,2	636,5
CV25G050_0410S_□□	25	0,5	21	16,1	446,7
CV25G075_0410S_□□	25	0,75	19	17,5	553,7
CV25G100_0410S_□□	25	1	18	19,0	669,9
CV25G150_0410S_□□	25	1,5	16	21,1	864,0

Composizione del codice - Code composition

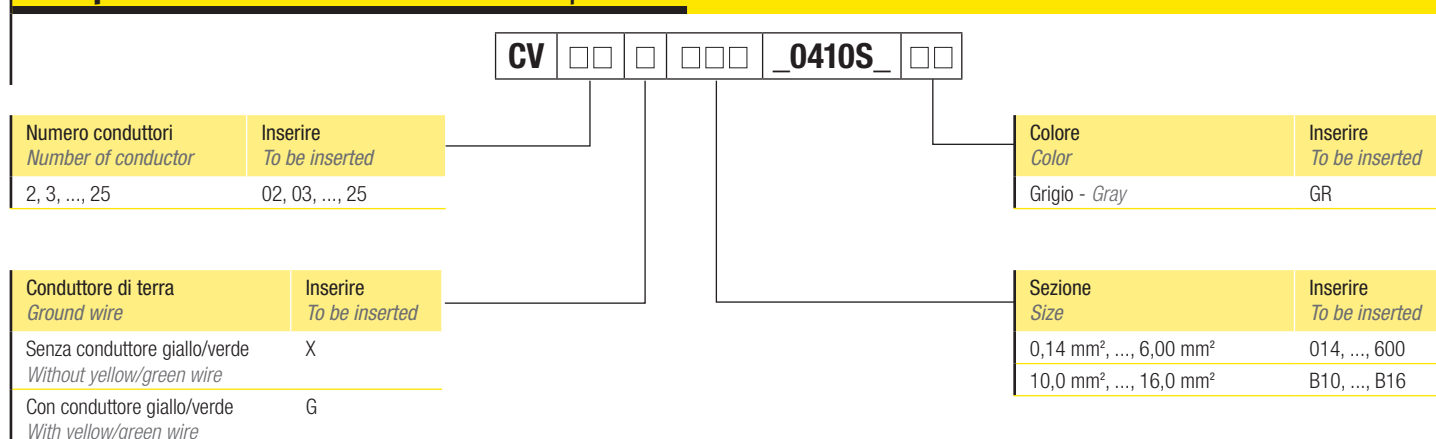

SERIES
440

Cavi multipolari multinorma antiolio

Multi-norm oil-resistant cables

Posa mobile, non schermati - Dynamic application, unshielded



UL US

RoHS

CE UK

Impiego - Use

Cavi non schermati per impiego mobile su assi cartesiani. Vengono normalmente utilizzati per l'equipaggiamento di apparecchiature destinate sia al mercato Europeo (CE) che ai mercati nord americani e canadesi. La guaina realizzata con mescola di PVC garantisce una buona flessibilità ed una ottima resistenza all'abrasione; questi cavi sono resistenti agli olii ed ai fluidi industriali più utilizzati. La marcatura metrica stampigliata sulla guaina del cavo ne favorisce la lavorazione e l'installazione.

Unshielded cables for mobile use on Cartesian axes. They are normally used for equipments meant for the European (EC), North American and Canadian markets. The jacket, made of PVC compound, grants a good flexibility and a very good resistance to abrasion; these cables exhibit a resistance to the most common industrial oils and fluids. The metric marked on the jacket allows an easier processing and installation of the cable.

Informazione. Si effettua, su richiesta, un servizio aggiuntivo di taglio a misura certificato UL ("Processed Wire").

Information. An additional UL certified cut-to-length service is carried out on request ("Processed Wire").

Dati tecnici - Technical data

Caratteristica - Characteristics	Valore/proprietà - Value/property
Conduttore <i>Conductor</i>	Trefolo flessibile in rame, classe 5/6 <i>Flexible copper strand, class 5/6</i>
Isolamento <i>Insulation</i>	TKblend®-L
Distinzione conduttori <i>Conductor distinction</i>	Sezioni <0,5 mm ² : colorati DIN 47100 Sezioni ≥0,5 mm ² : neri numerati + giallo/verde (a partire dai 3 conduttori) <i>Size <0,5 mm² (signaling cables): DIN 47100 colored</i> <i>Size ≥0,5 mm² (control/power cables): black numbered + yellow/green (beginning from 3 conductors)</i>
Riempitivi <i>Fillers</i>	Eventuali riempitivi centrali o laterali <i>Central or side fillers, if any</i>
Nastratura <i>Taping</i>	Nastro sintetico non igroscopico <i>Synthetic non-hygroscopic tape</i>
Guaina <i>Jacket</i>	Mescola di PVC antiolio, colore grigio RAL 7001. Marcatura metrica. <i>PVC compound, oil-resistant, RAL 7001 gray color.</i> <i>Metric marking.</i>
Temperatura di esercizio <i>Temperature range</i>	-5°C, +80°C (posa mobile); -30°C, +80°C (posa fissa) <i>-5°C, +80°C (dynamic); -30°C, +80°C (fixed)</i>
Tensione nominale <i>Voltage rating</i>	Sezioni ≤0,75 mm ² : 300 V (UL-CSA), 300/500 V (IEC) Sezioni > 0,75 mm ² : 1000 V (UL-CSA), 600/1000 V (IEC) <i>Size ≤0,75 mm²: 300 V (UL-CSA), 300/500 V (IEC)</i> <i>Size >0,75 mm²: 1000 V (UL-CSA), 600/1000 V (IEC)</i>
Tensione di prova <i>Test voltage</i>	2000/4000 V
Velocità <i>Speed</i>	180 m/min
Accelerazione <i>Acceleration</i>	7 m/s ²
Raggio di curvatura <i>Bending radius</i>	7,5 volte diametro esterno del cavo <i>7,5 x cable outer diameter</i>
Riferimenti normativi costruttivi <i>Standards of construction</i>	Flame res.: IEC 60332-1, CEI 20-35, UL VW-1, CSA FT2 I Oil res.: VDE 0472 (part 803/B), UL 1581 I Other: CEI EN 60228, EN 60228, UL 758, CSA AWM I/II A/B, cURus AWM Style 2464/2570
Riferimenti normativi d'impiego <i>Standards of use</i>	ANSI/NFPA 79, UL 508a, CSA C22.1 (CE Code), CSA C22.2 No.286, Style 2464/2570

Marcatura - Marking

TEKIMA 04400 – CE 4G1 mm² 80°C 600/1000 V CEI 20-35 IEC 60332-1 – c(UR)us E314444 AWM Style 2570 4x18 AWG 80°C 1000 V VW-1 Class I/II A/B FT2 – (prod.reference) = (metric) =

Codifiche e dimensioni - Coding and dimensions

Codice <i>Code</i>	Numero di conduttori <i>Number of conductors</i>	Sezione Size [mm ²]	Sezione Size [AWG]	Diametro Diameter [mm]	Peso Weight [kg/km]	Tensione Voltage [V]
CV02X035_04400_□□	2	0,35	22	4,4	22	300/500 (IEC), 300 (UL-CSA)
CV02X050_04400_□□	2	0,5	21	4,9	33	300/500 (IEC), 300 (UL-CSA)
CV02X075_04400_□□	2	0,75	19	5,8	38	300/500 (IEC), 300 (UL-CSA)
CV02X100_04400_□□	2	1	18	5,9	51	600/1000 (IEC), 1000 (UL-CSA)
CV02X150_04400_□□	2	1,5	16	7,5	68	600/1000 (IEC), 1000 (UL-CSA)
CV02X250_04400_□□	2	2,5	14	8,7	97	600/1000 (IEC), 1000 (UL-CSA)

Cavi multipolari per posa mobile - Cables for dynamic applications

Codice Code	Numero di conduttori Number of conductors	Sezione Size [mm ²]	Sezione Size [AWG]	Diametro Diameter [mm]	Peso Weight [kg/km]	Tensione Voltage [V]
CV03X035_04400_□□	3	0,35	22	4,6	26	300/500 (IEC), 300 (UL-CSA)
CV03G050_04400_□□	3	0,5	21	5,2	38	300/500 (IEC), 300 (UL-CSA)
CV03G075_04400_□□	3	0,75	19	6,1	47	300/500 (IEC), 300 (UL-CSA)
CV03G100_04400_□□	3	1	18	6,3	63	600/1000 (IEC), 1000 (UL-CSA)
CV03G150_04400_□□	3	1,5	16	7,7	95	600/1000 (IEC), 1000 (UL-CSA)
CV03G250_04400_□□	3	2,5	14	9	132	600/1000 (IEC), 1000 (UL-CSA)
CV04X035_04400_□□	4	0,35	22	4,6	35	300/500 (IEC), 300 (UL-CSA)
CV04G050_04400_□□	4	0,5	21	5,6	47	300/500 (IEC), 300 (UL-CSA)
CV04G075_04400_□□	4	0,75	19	6,6	58	300/500 (IEC), 300 (UL-CSA)
CV04G100_04400_□□	4	1	18	7,6	90	600/1000 (IEC), 1000 (UL-CSA)
CV04G150_04400_□□	4	1,5	16	8,3	118	600/1000 (IEC), 1000 (UL-CSA)
CV04G250_04400_□□	4	2,5	14	10,2	177	600/1000 (IEC), 1000 (UL-CSA)
CV04G400_04400_□□	4	4	12	12,2	274	600/1000 (IEC), 1000 (UL-CSA)
CV04G600_04400_□□	4	6	10	14	385	600/1000 (IEC), 1000 (UL-CSA)
CV04GB10_04400_□□	4	10	8	17,5	578	600/1000 (IEC), 1000 (UL-CSA)
CV04GB16_04400_□□	4	16	6	21,3	756	600/1000 (IEC), 1000 (UL-CSA)
CV04GB25_04400_□□	4	25	4	25,5	1158	600/1000 (IEC), 1000 (UL-CSA)
CV04GB35_04400_□□	4	35	2	28,4	1566	600/1000 (IEC), 1000 (UL-CSA)
CV05X035_04400_□□	5	0,35	22	5,3	37	300/500 (IEC), 300 (UL-CSA)
CV05G050_04400_□□	5	0,5	21	6,3	53	300/500 (IEC), 300 (UL-CSA)
CV05G075_04400_□□	5	0,75	19	7,3	71	300/500 (IEC), 300 (UL-CSA)
CV05G100_04400_□□	5	1	18	8,2	105	600/1000 (IEC), 1000 (UL-CSA)
CV05G150_04400_□□	5	1,5	16	9,6	148	600/1000 (IEC), 1000 (UL-CSA)
CV05G250_04400_□□	5	2,5	14	11	207	600/1000 (IEC), 1000 (UL-CSA)
CV05G400_04400_□□	5	4	12	12,7	273	600/1000 (IEC), 1000 (UL-CSA)
CV05G600_04400_□□	5	6	10	14,2	373	600/1000 (IEC), 1000 (UL-CSA)
CV06X025_04400_□□	6	0,25	24	5	37	300/500 (IEC), 300 (UL-CSA)
CV06X035_04400_□□	6	0,35	22	5,3	45	300/500 (IEC), 300 (UL-CSA)
CV06G050_04400_□□	6	0,5	21	7	64	300/500 (IEC), 300 (UL-CSA)
CV06G075_04400_□□	6	0,75	19	7,9	83	300/500 (IEC), 300 (UL-CSA)
CV06G100_04400_□□	6	1	18	8,5	101	600/1000 (IEC), 1000 (UL-CSA)
CV06G150_04400_□□	6	1,5	16	10,4	152	600/1000 (IEC), 1000 (UL-CSA)
CV06G250_04400_□□	6	2,5	14	12,1	227	600/1000 (IEC), 1000 (UL-CSA)
CV07X035_04400_□□	7	0,35	22	n.a.	n.a.	300/500 (IEC), 300 (UL-CSA)
CV07G050_04400_□□	7	0,5	21	6,5	66	300/500 (IEC), 300 (UL-CSA)
CV07G075_04400_□□	7	0,75	19	n.a.	n.a.	300/500 (IEC), 300 (UL-CSA)
CV07G100_04400_□□	7	1	18	8,8	130	600/1000 (IEC), 1000 (UL-CSA)
CV07G150_04400_□□	7	1,5	16	10,1	175	600/1000 (IEC), 1000 (UL-CSA)
CV07G250_04400_□□	7	2,5	14	12,3	272	600/1000 (IEC), 1000 (UL-CSA)
CV07G400_04400_□□	7	4	12	15,3	386	600/1000 (IEC), 1000 (UL-CSA)
CV07G600_04400_□□	7	6	10	17,3	534	600/1000 (IEC), 1000 (UL-CSA)
CV08X035_04400_□□	8	0,35	22	6,5	57	300/500 (IEC), 300 (UL-CSA)
CV08G050_04400_□□	8	0,5	21	8	84	300/500 (IEC), 300 (UL-CSA)
CV08G075_04400_□□	8	0,75	19	9,3	112	300/500 (IEC), 300 (UL-CSA)
CV08G100_04400_□□	8	1	18	10	136	600/1000 (IEC), 1000 (UL-CSA)
CV08G150_04400_□□	8	1,5	16	12	201	600/1000 (IEC), 1000 (UL-CSA)
CV08G250_04400_□□	8	2,5	14	14,6	312	600/1000 (IEC), 1000 (UL-CSA)
CV10X035_04400_□□	10	0,35	22	7,5	74	300/500 (IEC), 300 (UL-CSA)
CV10G050_04400_□□	10	0,5	21	9,2	109	300/500 (IEC), 300 (UL-CSA)
CV10G075_04400_□□	10	0,75	19	10,6	141	300/500 (IEC), 300 (UL-CSA)
CV10G100_04400_□□	10	1	18	11,3	173	600/1000 (IEC), 1000 (UL-CSA)
CV10G150_04400_□□	10	1,5	16	14	262	600/1000 (IEC), 1000 (UL-CSA)
CV10G250_04400_□□	10	2,5	14	16,9	407	600/1000 (IEC), 1000 (UL-CSA)
CV12X025_04400_□□	12	0,25	24	6,5	62	300/500 (IEC), 300 (UL-CSA)
CV12X035_04400_□□	12	0,35	22	8,3	89	300/500 (IEC), 300 (UL-CSA)
CV12G050_04400_□□	12	0,5	21	9,1	121	300/500 (IEC), 300 (UL-CSA)
CV12G075_04400_□□	12	0,75	19	11,8	173	300/500 (IEC), 300 (UL-CSA)
CV12G100_04400_□□	12	1	18	12	226	600/1000 (IEC), 1000 (UL-CSA)
CV12G150_04400_□□	12	1,5	16	13,3	290	600/1000 (IEC), 1000 (UL-CSA)

Codice Code	Numero di conduttori Number of conductors	Sezione Size [mm ²]	Sezione Size [AWG]	Diametro Diameter [mm]	Peso Weight [kg/km]	Tensione Voltage [V]
CV12G250_04400_□□	12	2,5	14	17,4	449	600/1000 (IEC), 1000 (UL-CSA)
CV14X035_04400_□□	14	0,35	22	7,7	84	300/500 (IEC), 300 (UL-CSA)
CV14G050_04400_□□	14	0,5	21	9,5	124	300/500 (IEC), 300 (UL-CSA)
CV14G075_04400_□□	14	0,75	19	10,9	163	300/500 (IEC), 300 (UL-CSA)
CV14G100_04400_□□	14	1	18	11,7	202	600/1000 (IEC), 1000 (UL-CSA)
CV14G150_04400_□□	14	1,5	16	14,6	310	600/1000 (IEC), 1000 (UL-CSA)
CV14G250_04400_□□	14	2,5	14	17,4	479	600/1000 (IEC), 1000 (UL-CSA)
CV16X035_04400_□□	16	0,35	22	8,1	94	300/500 (IEC), 300 (UL-CSA)
CV16G050_04400_□□	16	0,5	21	9,9	139	300/500 (IEC), 300 (UL-CSA)
CV16G075_04400_□□	16	0,75	19	11,4	183	300/500 (IEC), 300 (UL-CSA)
CV16G100_04400_□□	16	1	18	12,5	231	600/1000 (IEC), 1000 (UL-CSA)
CV16G150_04400_□□	16	1,5	16	15,3	351	600/1000 (IEC), 1000 (UL-CSA)
CV16G250_04400_□□	16	2,5	14	18,3	542	600/1000 (IEC), 1000 (UL-CSA)
CV18X035_04400_□□	18	0,35	22	8,4	104	300/500 (IEC), 300 (UL-CSA)
CV18G050_04400_□□	18	0,5	21	10,9	177	300/500 (IEC), 300 (UL-CSA)
CV18G075_04400_□□	18	0,75	19	12	203	300/500 (IEC), 300 (UL-CSA)
CV18G100_04400_□□	18	1	18	13,8	311	600/1000 (IEC), 1000 (UL-CSA)
CV18G150_04400_□□	18	1,5	16	16,2	391	600/1000 (IEC), 1000 (UL-CSA)
CV18G250_04400_□□	18	2,5	14	19,5	614	600/1000 (IEC), 1000 (UL-CSA)
CV19G150_04400_□□	19	1,5	16	15,7	436	600/1000 (IEC), 1000 (UL-CSA)
CV25X035_04400_□□	25	0,35	22	9,5	142	300/500 (IEC), 300 (UL-CSA)
CV25G050_04400_□□	25	0,5	21	13,2	247	300/500 (IEC), 300 (UL-CSA)
CV25G075_04400_□□	25	0,75	19	14,8	328	300/500 (IEC), 300 (UL-CSA)
CV25G100_04400_□□	25	1	18	16,6	430	600/1000 (IEC), 1000 (UL-CSA)
CV25G150_04400_□□	25	1,5	16	18,9	587	600/1000 (IEC), 1000 (UL-CSA)
CV25G250_04400_□□	25	2,5	14	24,1	898	600/1000 (IEC), 1000 (UL-CSA)
CV34X100_04400_□□	34	1	18	18,8	570	600/1000 (IEC), 1000 (UL-CSA)

Composizione del codice - Code composition

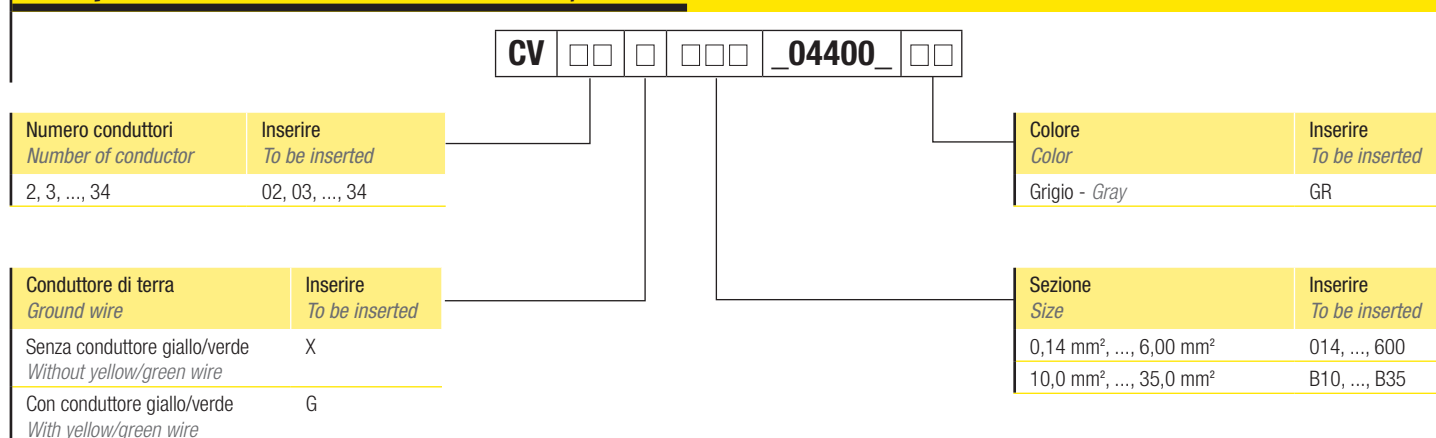

**SERIES
440S**

Cavi multipolari multinorma antiolio

Multi-norm oil-resistant cables

Posa mobile, schermati - Dynamic application, shielded



Impiego - Use

Cavi schermati per impiego mobile su assi cartesiani. Vengono normalmente utilizzati per l'equipaggiamento di apparecchiature destinate sia al mercato Europeo (CE) che ai mercati nord americani e canadesi. La guaina realizzata con mescola di PVC garantisce una buona flessibilità ed una ottima resistenza all'abrasione; questi cavi sono resistenti agli olii ed ai fluidi industriali più utilizzati. La marcatura metrica stampigliata sulla guaina del cavo ne favorisce la lavorazione e l'installazione.

Shielded cables for mobile use on Cartesian axes. They are normally used for equipments meant for the European (EC), North American and Canadian markets. The jacket, made of PVC compound, grants a good flexibility and a very good resistance to abrasion; these cables exhibit a resistance to the most common industrial oils and fluids. The metric marked on the jacket allows an easier processing and installation of the cable.

Informazione. Si effettua, su richiesta, un servizio aggiuntivo di taglio a misura certificato UL ("Processed Wire").

Information. An additional UL certified cut-to-length service is carried out on request ("Processed Wire").

Dati tecnici - Technical data

Caratteristica - Characteristics	Valore/proprietà - Value/property
Conduttore <i>Conductor</i>	Trefolo flessibile in rame, classe 5/6 <i>Flexible copper strand, class 5/6</i>
Isolamento <i>Insulation</i>	TKblend®-L
Distinzione conduttori <i>Conductor distinction</i>	Sezioni <0,5 mm ² : colorati DIN 47100 Sezioni ≥0,5 mm ² : neri numerati + giallo/verde (a partire dai 3 conduttori) <i>Size <0,5 mm² (signaling cables): DIN 47100 colored</i> <i>Size ≥0,5 mm² (control/power cables): black numbered + yellow/green (beginning from 3 conductors)</i>
Riempitivi <i>Fillers</i>	Eventuali riempitivi centrali o laterali <i>Central or side fillers, if any</i>
Nastratura <i>Taping</i>	Nastro sintetico non igroscopico <i>Synthetic non-hygroscopic tape</i>
Schermatura <i>Shield</i>	Treccia di rame stagnato, ricopertura nom. 80% <i>Tinned copper braid, nom. coverage 80%</i>
Guaina <i>Jacket</i>	Mescola di PVC antiolio, colore grigio RAL 7001. Marcatura metrica. <i>PVC compound, oil-resistant, RAL 7001 gray color. Metric marking.</i>
Temperatura di esercizio <i>Temperature range</i>	-5°C, +80°C (posa mobile); -30°C, +80°C (posa fissa) <i>-5°C, +80°C (dynamic); -30°C, +80°C (fixed)</i>
Tensione nominale <i>Voltage rating</i>	Sezioni ≤0,75 mm ² : 300 V (UL-CSA), 300/500 V (IEC) Sezioni > 0,75 mm ² : 1000 V (UL-CSA), 600/1000 V (IEC) <i>Size ≤0,75 mm²: 300 V (UL-CSA), 300/500 V (IEC)</i> <i>Size >0,75 mm²: 1000 V (UL-CSA), 600/1000 V (IEC)</i>
Tensione di prova <i>Test voltage</i>	2000/4000 V
Velocità <i>Speed</i>	180 m/min
Accelerazione <i>Acceleration</i>	7 m/s ²
Raggio di curvatura <i>Bending radius</i>	7,5 volte diametro esterno del cavo <i>7,5 x cable outer diameter</i>
Riferimenti normativi costruttivi <i>Standards of construction</i>	Flame res.: IEC 60332-1, CEI 20-35, UL VW-1, CSA FT2 I Oil res.: VDE 0472 (part 803/B), UL 1581 I Other: CEI EN 60228, EN 60228, UL 758, CSA AWM I/II A/B, cURus AWM Style 2464/2570
Riferimenti normativi d'impiego <i>Standards of use</i>	ANSI/NFPA 79, UL 508a, CSA C22.1 (CE Code), CSA C22.2 No.286, Style 2464/2570

Marcatura - Marking

TEKIMA 0440S – CE 4G1 mm² 80°C 600/1000 V CEI 20-35 IEC 60332-1 – c(UR)us E314444 AWM Style 2570 4x18 AWG 80°C 1000 V VW-1 Class I/II A/B FT2 – (prod.reference) = (metric) =

Codifiche e dimensioni - Coding and dimensions

Codice <i>Code</i>	Numero di conduttori <i>Number of conductors</i>	Sezione Size [mm ²]	Sezione Size [AWG]	Diametro Diameter [mm]	Peso Weight [kg/km]	Tensione Voltage [V]
CV02X035_0440S_□□	2	0,35	22	4,5	31	300/500 (IEC), 300 (UL-CSA)
CV02X050_0440S_□□	2	0,5	21	5,3	42	300/500 (IEC), 300 (UL-CSA)
CV02X075_0440S_□□	2	0,75	19	6,3	49	300/500 (IEC), 300 (UL-CSA)
CV02X100_0440S_□□	2	1	18	6,3	60	600/1000 (IEC), 1000 (UL-CSA)

Codice Code	Numero di conduttori Number of conductors	Sezione Size [mm ²]	Sezione Size [AWG]	Diametro Diameter [mm]	Peso Weight [kg/km]	Tensione Voltage [V]
CV02X150_0440S_□□	2	1,5	16	8	81	600/1000 (IEC), 1000 (UL-CSA)
CV02X250_0440S_□□	2	2,5	14	9,5	122	600/1000 (IEC), 1000 (UL-CSA)
CV03X035_0440S_□□	3	0,35	22	5,1	35	300/500 (IEC), 300 (UL-CSA)
CV03G050_0440S_□□	3	0,5	21	5,9	46	300/500 (IEC), 300 (UL-CSA)
CV03G075_0440S_□□	3	0,75	19	6,6	58	300/500 (IEC), 300 (UL-CSA)
CV03G100_0440S_□□	3	1	18	7,2	70	600/1000 (IEC), 1000 (UL-CSA)
CV03G150_0440S_□□	3	1,5	16	8,2	111	600/1000 (IEC), 1000 (UL-CSA)
CV03G250_0440S_□□	3	2,5	14	10	150	600/1000 (IEC), 1000 (UL-CSA)
CV04X035_0440S_□□	4	0,35	22	5	43	300/500 (IEC), 300 (UL-CSA)
CV04G050_0440S_□□	4	0,5	21	6,3	55	300/500 (IEC), 300 (UL-CSA)
CV04G075_0440S_□□	4	0,75	19	7,3	74	300/500 (IEC), 300 (UL-CSA)
CV04G100_0440S_□□	4	1	18	8,1	110	600/1000 (IEC), 1000 (UL-CSA)
CV04G150_0440S_□□	4	1,5	16	8,8	135	600/1000 (IEC), 1000 (UL-CSA)
CV04G250_0440S_□□	4	2,5	14	10,6	197	600/1000 (IEC), 1000 (UL-CSA)
CV04G400_0440S_□□	4	4	12	12,7	294	600/1000 (IEC), 1000 (UL-CSA)
CV04G600_0440S_□□	4	6	10	14,7	410	600/1000 (IEC), 1000 (UL-CSA)
CV04GB10_0440S_□□	4	10	8	18,4	654	600/1000 (IEC), 1000 (UL-CSA)
CV04GB16_0440S_□□	4	16	6	22,4	984	600/1000 (IEC), 1000 (UL-CSA)
CV04GB25_0440S_□□	4	25	4	26,8	1288	600/1000 (IEC), 1000 (UL-CSA)
CV04GB35_0440S_□□	4	35	2	30,1	1729	600/1000 (IEC), 1000 (UL-CSA)
CV05X035_0440S_□□	5	0,35	22	5,8	48	300/500 (IEC), 300 (UL-CSA)
CV05G050_0440S_□□	5	0,5	21	7	75	300/500 (IEC), 300 (UL-CSA)
CV05G075_0440S_□□	5	0,75	19	7,8	85	300/500 (IEC), 300 (UL-CSA)
CV05G100_0440S_□□	5	1	18	8,4	100	600/1000 (IEC), 1000 (UL-CSA)
CV05G150_0440S_□□	5	1,5	16	9,9	165	600/1000 (IEC), 1000 (UL-CSA)
CV05G250_0440S_□□	5	2,5	14	11,5	228	600/1000 (IEC), 1000 (UL-CSA)
CV05G400_0440S_□□	5	4	12	13,5	310	600/1000 (IEC), 1000 (UL-CSA)
CV05G600_0440S_□□	5	6	10	15,1	417	600/1000 (IEC), 1000 (UL-CSA)
CV06X035_0440S_□□	6	0,35	22	5,7	54	300/500 (IEC), 300 (UL-CSA)
CV06G050_0440S_□□	6	0,5	21	7,5	78	300/500 (IEC), 300 (UL-CSA)
CV06G075_0440S_□□	6	0,75	19	8,5	98	300/500 (IEC), 300 (UL-CSA)
CV06G100_0440S_□□	6	1	18	9,3	128	600/1000 (IEC), 1000 (UL-CSA)
CV06G150_0440S_□□	6	1,5	16	11	178	600/1000 (IEC), 1000 (UL-CSA)
CV06G250_0440S_□□	6	2,5	14	13,1	268	600/1000 (IEC), 1000 (UL-CSA)
CV07X035_0440S_□□	7	0,35	22	n.a.	n.a.	300/500 (IEC), 300 (UL-CSA)
CV07G050_0440S_□□	7	0,5	21	n.a.	n.a.	300/500 (IEC), 300 (UL-CSA)
CV07G075_0440S_□□	7	0,75	19	n.a.	n.a.	300/500 (IEC), 300 (UL-CSA)
CV07G100_0440S_□□	7	1	18	9,3	151	600/1000 (IEC), 1000 (UL-CSA)
CV07G150_0440S_□□	7	1,5	16	10,6	204	600/1000 (IEC), 1000 (UL-CSA)
CV07G250_0440S_□□	7	2,5	14	n.a.	n.a.	600/1000 (IEC), 1000 (UL-CSA)
CV07G400_0440S_□□	7	4	12	16	432	600/1000 (IEC), 1000 (UL-CSA)
CV07G600_0440S_□□	7	6	10	18,2	601	600/1000 (IEC), 1000 (UL-CSA)
CV08X035_0440S_□□	8	0,35	22	6,5	69	300/500 (IEC), 300 (UL-CSA)
CV08G050_0440S_□□	8	0,5	21	8,6	107	300/500 (IEC), 300 (UL-CSA)
CV08G075_0440S_□□	8	0,75	19	10	137	300/500 (IEC), 300 (UL-CSA)
CV08G100_0440S_□□	8	1	18	10,6	163	600/1000 (IEC), 1000 (UL-CSA)
CV08G150_0440S_□□	8	1,5	16	13	245	600/1000 (IEC), 1000 (UL-CSA)
CV08G250_0440S_□□	8	2,5	14	15,3	358	600/1000 (IEC), 1000 (UL-CSA)
CV10X035_0440S_□□	10	0,35	22	8	89	300/500 (IEC), 300 (UL-CSA)
CV10G050_0440S_□□	10	0,5	21	9,8	134	300/500 (IEC), 300 (UL-CSA)
CV10G075_0440S_□□	10	0,75	19	11,2	167	300/500 (IEC), 300 (UL-CSA)
CV10G100_0440S_□□	10	1	18	12	203	600/1000 (IEC), 1000 (UL-CSA)
CV10G150_0440S_□□	10	1,5	16	14,9	314	600/1000 (IEC), 1000 (UL-CSA)
CV10G250_0440S_□□	10	2,5	14	17,6	460	600/1000 (IEC), 1000 (UL-CSA)
CV12X035_0440S_□□	12	0,35	22	7,2	90	300/500 (IEC), 300 (UL-CSA)
CV12G050_0440S_□□	12	0,5	21	10,1	156	300/500 (IEC), 300 (UL-CSA)
CV12G075_0440S_□□	12	0,75	19	12,8	220	300/500 (IEC), 300 (UL-CSA)
CV12G100_0440S_□□	12	1	18	12,5	258	600/1000 (IEC), 1000 (UL-CSA)
CV12G150_0440S_□□	12	1,5	16	16,8	384	600/1000 (IEC), 1000 (UL-CSA)

Cavi multipolari per posa mobile - Cables for dynamic applications

Codice Code	Numero di conduttori Number of conductors	Sezione Size [mm ²]	Sezione Size [AWG]	Diametro Diameter [mm]	Peso Weight [kg/km]	Tensione Voltage [V]
CV12G250_0440S_□□	12	2,5	14	18,3	512	600/1000 (IEC), 1000 (UL-CSA)
CV14X035_0440S_□□	14	0,35	22	8,2	100	300/500 (IEC), 300 (UL-CSA)
CV14G050_0440S_□□	14	0,5	21	10,1	150	300/500 (IEC), 300 (UL-CSA)
CV14G075_0440S_□□	14	0,75	19	11,5	192	300/500 (IEC), 300 (UL-CSA)
CV14G100_0440S_□□	14	1	18	12,6	248	600/1000 (IEC), 1000 (UL-CSA)
CV14G150_0440S_□□	14	1,5	16	15,3	357	600/1000 (IEC), 1000 (UL-CSA)
CV14G250_0440S_□□	14	2,5	14	18,3	553	600/1000 (IEC), 1000 (UL-CSA)
CV16X035_0440S_□□	16	0,35	22	8,7	117	300/500 (IEC), 300 (UL-CSA)
CV16G050_0440S_□□	16	0,5	21	10,5	167	300/500 (IEC), 300 (UL-CSA)
CV16G075_0440S_□□	16	0,75	19	12,4	229	300/500 (IEC), 300 (UL-CSA)
CV16G100_0440S_□□	16	1	18	13,2	276	600/1000 (IEC), 1000 (UL-CSA)
CV16G150_0440S_□□	16	1,5	16	16,1	401	600/1000 (IEC), 1000 (UL-CSA)
CV16G250_0440S_□□	16	2,5	14	19,4	624	600/1000 (IEC), 1000 (UL-CSA)
CV18X035_0440S_□□	18	0,35	22	9	138	300/500 (IEC), 300 (UL-CSA)
CV18G050_0440S_□□	18	0,5	21	11	184	300/500 (IEC), 300 (UL-CSA)
CV18G075_0440S_□□	18	0,75	19	12,9	253	300/500 (IEC), 300 (UL-CSA)
CV18G100_0440S_□□	18	1	18	14,4	355	600/1000 (IEC), 1000 (UL-CSA)
CV18G150_0440S_□□	18	1,5	16	17,1	452	600/1000 (IEC), 1000 (UL-CSA)
CV18G250_0440S_□□	18	2,5	14	20,6	702	600/1000 (IEC), 1000 (UL-CSA)
CV25X035_0440S_□□	25	0,35	22	10,8	190	300/500 (IEC), 300 (UL-CSA)
CV25G050_0440S_□□	25	0,5	21	13,4	265	300/500 (IEC), 300 (UL-CSA)
CV25G075_0440S_□□	25	0,75	19	15,5	350	300/500 (IEC), 300 (UL-CSA)
CV25G100_0440S_□□	25	1	18	17,2	487	600/1000 (IEC), 1000 (UL-CSA)
CV25G150_0440S_□□	25	1,5	16	21	660	600/1000 (IEC), 1000 (UL-CSA)
CV25G250_0440S_□□	25	2,5	14	25,1	999	600/1000 (IEC), 1000 (UL-CSA)
CV36X035_0440S_□□	36	0,35	22	12,2	254	300/500 (IEC), 300 (UL-CSA)

Composizione del codice - Code composition

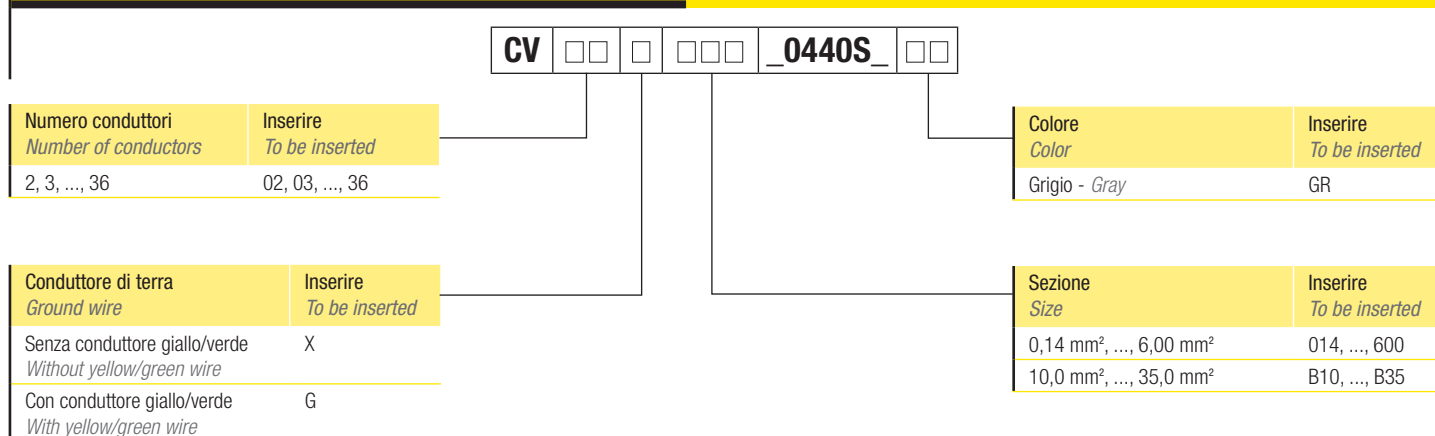

**SERIES
440S**

Cavi multipolari multinorma antiolio per servomotori



Multi-norm oil-resistant cables for servo motors

Posa mobile, schermati - Dynamic application, shielded

UL US



RoHS

CE UK
CA



Impiego - Use

Cavi schermati per impiego mobile su assi cartesiani. Vengono normalmente utilizzati per l'equipaggiamento di apparecchiature destinate sia al mercato Europeo (CE) che ai mercati nord americani e canadesi. La guaina realizzata con mescola di PVC garantisce una buona flessibilità ed una ottima resistenza all'abrasione; questi cavi sono resistenti agli olii ed ai fluidi industriali più utilizzati. La marcatura metrica stampigliata sulla guaina del cavo ne favorisce la lavorazione e l'installazione.

Shielded cables for mobile use on Cartesian axes. They are normally used for equipments meant for the European (EC), North American and Canadian markets. The jacket, made of PVC compound, grants a good flexibility and a very good resistance to abrasion; these cables exhibit a resistance to the most common industrial oils and fluids. The metric marked on the jacket allows an easier processing and installation of the cable.

Informazione. Si effettua, su richiesta, un servizio aggiuntivo di taglio a misura certificato UL ("Processed Wire").

Information. An additional UL certified cut-to-length service is carried out on request ("Processed Wire").

Marcatura - Marking

TEKIMA 0440S - CE (4G1,5+(2x1)) mm² 80°C 600/1000 V CEI 20-35 IEC 60332-1 - c(UR)us E314444 AWM Style 2570 (4x18+(2x16)) AWG 80°C 1000 V VW-1 Class I/II A/B FT2 - (prod.reference) = (metric) =

Dati tecnici - Technical data

Caratteristica - Characteristics	Valore/proprietà - Value/property
Conduttore <i>Conductor</i>	Trefolo flessibile in rame, classe 5/6 <i>Flexible copper strand, class 5/6</i>
Isolamento <i>Insulation</i>	TKblend®-L
Distinzione conduttori <i>Conductor distinction</i>	Potenza: neri numerati + giallo/verde. Segnale: neri numerati <i>Power: black numbered + yellow/green. Signal: black numbered</i>
Riempitivi <i>Fillers</i>	Eventuali riempitivi centrali o laterali <i>Central or side fillers, if any</i>
Schermatura coppie <i>Pairs shield</i>	Treccia di rame stagnato con ricopertura nom. 80% <i>Tinned copper braid, nom. coverage 80%</i>
Nastratura coppie <i>Pairs taping</i>	Tessuto non tessuto <i>Non-woven tape</i>
Nastratura totale <i>Total taping</i>	Nastro sintetico non igroscopico <i>Synthetic non-hygroscopic tape</i>
Schermatura <i>Shield</i>	Treccia di rame stagnato con ricopertura nom. 80% <i>Tinned copper braid, nom. coverage 80%</i>
Guaina <i>Jacket</i>	Mescola di PVC antiolio, colore arancione Desina RAL 2003. Marcatura metrica. <i>PVC compound, oil-resistant, Desina RAL 2003 orange color. Metric marking.</i>
Temperatura di esercizio <i>Temperature range</i>	-5°C, +80°C (posa mobile); -30°C, +80°C (posa fissa) <i>-5°C, +80°C (dynamic); -30°C, +80°C (fixed)</i>
Tensione nominale <i>Voltage rating</i>	1000 V (UL-CSA), 600/1000 V (IEC)
Tensione di prova <i>Test voltage</i>	2000/4000 V
Velocità <i>Speed</i>	180 m/min
Accelerazione <i>Acceleration</i>	7 m/s ²
Raggio di curvatura <i>Bending radius</i>	15 volte diametro esterno del cavo <i>15 x cable outer diameter</i>
Riferimenti normativi costruttivi <i>Standards of construction</i>	Flame res.: IEC 60332-1, CEI 20-35, UL VW-1, CSA FT2 Oil res.: VDE 0472 (part 803/B), UL 1581 Other: CEI EN 60228, EN 60228, UL 758, CSA AWM I/II A/B, cURus AWM Style 2570
Riferimenti normativi d'impiego <i>Standards of use</i>	ANSI/NFPA 79, UL 508a, CSA C22.1 (CE Code), CSA C22.2 No.286, Style 2570

Codifiche e dimensioni - Coding and dimensions

Codice <i>Code</i>	N° conduttori x sezione <i>Num. conductors x Size [mm²]</i>	N° conduttori x sezione <i>Num. conductors x Size [AWG]</i>	Diametro <i>Diameter [mm]</i>	Peso <i>Weight [kg/km]</i>
CVFM0001_0440S_D2	(4G1,5+(2x1))	(4x16+(2x18))	12,3	198
CVFM0002_0440S_D2	(4G1,5+(2x1,5))	(4x16+(2x16))	12,9	228
CVFM0003_0440S_D2	(4G1,5+2x(2x0,75))	(4x16+2x(2x19))	13,4	242
CVFM0004_0440S_D2	(4G1,5+2x(2x1))	(4x16+2x(2x18))	14,0	262

Codice Code	N° conduttori x sezione Num. conductors x Size [mm²]	N° conduttori x sezione Num. conductors x Size [AWG]	Diametro Diameter [mm]	Peso Weight [kg/km]
CVFM0025_0440S_D2	(4G1,5)	(4x16)	9,1	142
CVFM0005_0440S_D2	(4G2,5+(2x1))	(4x14+(2x18))	13,4	260
CVFM0006_0440S_D2	(4G2,5+(2x1,5))	(4x14+(2x16))	13,9	280
CVFM0007_0440S_D2	(4G2,5+2x(2x1))	(4x14+2x(2x18))	14,6	309
CVFM0008_0440S_D2	(4G2,5+2x(2x1,5))	(4x14+2x(2x16))	15,9	353
CVFM0026_0440S_D2	(4G2,5)	(4x14)	10,4	196
CVFM0009_0440S_D2	(4G4+(2x1))	(4x12+(2x18))	14,4	322
CVFM0010_0440S_D2	(4G4+(2x1,5))	(4x12+(2x16))	14,9	345
CVFM0011_0440S_D2	(4G4+2x(2x1))	(4x12+2x(2x18))	16,2	379
CVFM0027_0440S_D2	(4G4)	(4x12)	11,9	269
CVFM0012_0440S_D2	(4G4+2x(2x1,5))	(4x12+2x(2x16))	17,6	430
CVFM0013_0440S_D2	(4G6+(2x1))	(4x10+(2x18))	15,8	409
CVFM0014_0440S_D2	(4G6+(2x1,5))	(4x10+(2x16))	16,3	429
CVFM0028_0440S_D2	(4G6)	(4x10)	14,3	398
CVFM0015_0440S_D2	(4G6+2x(2x1,5))	(4x10+2x(2x16))	19,0	541
CVFM0016_0440S_D2	(4G10+(2x1))	(4x8+(2x18))	20,3	701
CVFM0017_0440S_D2	(4G10+(2x1,5))	(4x8+(2x16))	20,7	725
CVFM0018_0440S_D2	(4G10+2x(2x1,5))	(4x8+2x(2x16))	23,4	840
CVFM0019_0440S_D2	(4G16+(2x1))	(4x6+(2x18))	23,1	862
CVFM0020_0440S_D2	(4G16+(2x1,5))	(4x6+(2x16))	23,6	918
CVFM0021_0440S_D2	(4G16+2x(2x1,5))	(4x6+2x(2x16))	25,4	1018
CVFM0022_0440S_D2	(4G25+(2x1,5))	(4x4+(2x16))	27,1	1333
CVFM0023_0440S_D2	(4G25+2x(2x1,5))	(4x4+2x(2x16))	29	1443
CVFM0024_0440S_D2	(4G35+(2x1,5))	(4x2+(2x16))	29	1861

Composizione del codice - Code composition

CVFM □□□□ _0440S_ □□	Colore Color Arancione Desina Orange Desina	Inserire To be inserted D2
Formazione Construction Codice identificativo della particolare formazione del cavo. Identifier code of the cable construction.		

**SERIES
600**

Cavi multipolari multinorma antiolio altamente flessibili



Multi-norm oil-resistant high flexible cables

Posa mobile, non schermati - Dynamic application, unshielded



cULus

RoHS

CE UKCA

Impiego - Use

Cavi progettati per impiego mobile in catena porta cavi anche di elevata lunghezza (movimentazione continue su assi cartesiani); trovano impiego anche su robot antropomorfi per movimentazione in flessione torsione. Vengono normalmente utilizzati per l'equipaggiamento di apparecchiature destinate sia al mercato Europeo (CE) che ai mercati nord americani e canadesi. La speciale miscela in poliuretano della guaina esterna garantisce ottime prestazioni meccaniche, resistenza all'abrasione ed all'accelerazione oltre che una eccellente resistenza agli olii e fluidi industriali più utilizzati. La marcatura metrica stampigliata sulla guaina del cavo ne favorisce la lavorazione e l'installazione.

Cables planned for mobile use on a cable holder chain, even with great length (continuous motion on Cartesian axis); they are used also on anthropomorphic robot for flexotorsion motion. They are normally used for equipments meant for the European (EC), North American and Canadian markets. The special polyurethane compound of the external jacket grants very good mechanical performance, abrasion and acceleration resistance, and a very good resistance to the most common industrial oils and fluids. The metric marked on the jacket allows an easier processing and installation of the cable.

Informazione. Si effettua, su richiesta, un servizio aggiuntivo di taglio a misura certificato UL ("Processed Wire").

Information. An additional UL certified cut-to-length service is carried out on request ("Processed Wire").

Dati tecnici - Technical data

Caratteristica - Characteristics	Valore/proprietà - Value/property
Conduttore <i>Conductor</i>	Trefolo flessibile in rame, classe 5/6 <i>Flexible copper strand, class 5/6</i>
Isolamento <i>Insulation</i>	TKblend®-L
Distinzione conduttori <i>Conductor distinction</i>	Sezioni <0,5 mm ² : colorati DIN 47100 Sezioni ≥0,5 mm ² : neri numerati + giallo/verde (a partire dai 3 conduttori) <i>Size <0,5 mm² (signaling cables): DIN 47100 colored</i> <i>Size ≥0,5 mm² (control/power cables): black numbered + yellow/green (beginning from 3 conductors)</i>
Riempitivi <i>Fillers</i>	Eventuali riempitivi centrali o laterali <i>Central or side fillers, if any</i>
Nastratura <i>Taping</i>	Doppio nastro sintetico non igroscopico <i>Double synthetic non-hygroscopic tape</i>
Guaina <i>Jacket</i>	Miscela di poliuretano antiolio e antifiamma, colore grigio RAL 7001. Marcatura metrica. <i>Polyurethane compound, oil-resistant and flame-resistant, RAL 7001 gray color. Metric marking.</i>
Temperatura di esercizio <i>Temperature range</i>	-30°C, +80°C (posa mobile); -40°C, +80°C (posa fissa) <i>-30°C, +80°C (dynamic); -40°C, +80°C (fixed)</i>
Tensione nominale <i>Voltage rating</i>	Sezioni ≤0,75 mm ² : 300 V (UL-CSA), 300/500 V (IEC) Sezioni > 0,75 mm ² : 1000 V (UL-CSA), 600/1000 V (IEC) <i>Size ≤0,75 mm²: 300 V (UL-CSA), 300/500 V (IEC)</i> <i>Size >0,75 mm²: 1000 V (UL-CSA), 600/1000 V (IEC)</i>
Tensione di prova <i>Test voltage</i>	2000/4000 V
Velocità <i>Speed</i>	220 m/min*
Accelerazione <i>Acceleration</i>	10 m/s ²
Raggio di curvatura <i>Bending radius</i>	5 volte diametro esterno del cavo <i>5 x cable outer diameter</i>
Riferimenti normativi costruttivi <i>Standards of construction</i>	Flame res.: IEC 60332-1, CEI 20-35, UL VW-1, CSA FT1 Oil res.: VDE 0472 (part 803/B), UL 1581 Other: CEI EN 60228, EN 60228, UL 758, CSA AWM I/II A/B, cURus AWM Style 20940 or 21209
Riferimenti normativi d'impiego <i>Standards of use</i>	ANSI/NFPA 79, UL 508a, CSA C22.1 (CE Code), CSA C22.2 No.286, Style 20940 or 21209

* Per velocità superiori ai 220 m/min chiedere all'ufficio commerciale.

** For speed greater than 220 m/min ask the sales department.*

Marcatura - Marking

TEKIMA 06000 – CE 4G6 mm² 80°C 1000 V CEI 20-35 IEC 60332-1 – c(UR)us E314444 AWM 20940 4x10 AWG 80°C 1000 V VW-1 Class I/II A/B FT1 – (prod.reference) = (metric) =

Codifiche e dimensioni - Coding and dimensions

Codice <i>Code</i>	Numero di conduttori <i>Number of conductors</i>	Sezione <i>Size [mm²]</i>	Sezione <i>Size [AWG]</i>	Diametro <i>Diameter [mm]</i>	Peso <i>Weight [kg/km]</i>	Tensione <i>Voltage [V]</i>
CV02X035_06000_□□	2	0,35	22	4,4	22	300/500 (IEC), 300 (UL-CSA)
CV02X050_06000_□□	2	0,5	21	5,1	32	300/500 (IEC), 300 (UL-CSA)
CV02X075_06000_□□	2	0,75	19	5,7	39	300/500 (IEC), 300 (UL-CSA)
CV02X100_06000_□□	2	1	18	6,3	50	600/1000 (IEC), 1000 (UL-CSA)
CV02X150_06000_□□	2	1,5	16	6,9	65	600/1000 (IEC), 1000 (UL-CSA)
CV02X250_06000_□□	2	2,5	14	9,3	104	600/1000 (IEC), 1000 (UL-CSA)
CV03X022_06000_□□	3	0,22	24	4,1	21	300/500 (IEC), 300 (UL-CSA)
CV03X035_06000_□□	3	0,35	22	4,6	25	300/500 (IEC), 300 (UL-CSA)
CV03G050_06000_□□	3	0,5	21	6,2	43	300/500 (IEC), 300 (UL-CSA)
CV03G075_06000_□□	3	0,75	19	6,9	54	300/500 (IEC), 300 (UL-CSA)
CV03G100_06000_□□	3	1	18	6,8	67	600/1000 (IEC), 1000 (UL-CSA)
CV03G150_06000_□□	3	1,5	16	7,3	83	600/1000 (IEC), 1000 (UL-CSA)
CV03G250_06000_□□	3	2,5	14	9,7	144	600/1000 (IEC), 1000 (UL-CSA)
CV03G400_06000_□□	3	4	12	10,9	201	600/1000 (IEC), 1000 (UL-CSA)
CV04X035_06000_□□	4	0,35	22	5	31	300/500 (IEC), 300 (UL-CSA)
CV04G050_06000_□□	4	0,5	21	6	48	300/500 (IEC), 300 (UL-CSA)
CV04G075_06000_□□	4	0,75	19	6,9	65	300/500 (IEC), 300 (UL-CSA)
CV04G100_06000_□□	4	1	18	7,6	86	600/1000 (IEC), 1000 (UL-CSA)
CV04G150_06000_□□	4	1,5	16	8,5	110	600/1000 (IEC), 1000 (UL-CSA)
CV04G250_06000_□□	4	2,5	14	10,6	180	600/1000 (IEC), 1000 (UL-CSA)
CV04G400_06000_□□	4	4	12	11,8	249	600/1000 (IEC), 1000 (UL-CSA)
CV04G600_06000_□□	4	6	10	13,5	348	600/1000 (IEC), 1000 (UL-CSA)
CV04GB10_06000_□□	4	10	8	18,6	610	600/1000 (IEC), 1000 (UL-CSA)
CV04GB16_06000_□□	4	16	6	21,9	928	600/1000 (IEC), 1000 (UL-CSA)
CV04GB25_06000_□□	4	25	4	25,3	1134	600/1000 (IEC), 1000 (UL-CSA)
CV04GB35_06000_□□	4	35	2	28	140	600/1000 (IEC), 1000 (UL-CSA)
CV05X035_06000_□□	5	0,35	22	5,3	36	300/500 (IEC), 300 (UL-CSA)
CV05G050_06000_□□	5	0,5	21	6,9	62	300/500 (IEC), 300 (UL-CSA)
CV05G075_06000_□□	5	0,75	19	7,9	77	300/500 (IEC), 300 (UL-CSA)
CV05G100_06000_□□	5	1	18	8,3	100	600/1000 (IEC), 1000 (UL-CSA)
CV05G150_06000_□□	5	1,5	16	9,3	132	600/1000 (IEC), 1000 (UL-CSA)
CV05G250_06000_□□	5	2,5	14	11,6	212	600/1000 (IEC), 1000 (UL-CSA)
CV05G400_06000_□□	5	4	12	13,4	310	600/1000 (IEC), 1000 (UL-CSA)
CV05G600_06000_□□	5	6	10	15	422	600/1000 (IEC), 1000 (UL-CSA)
CV06X035_06000_□□	6	0,35	22	5,7	42	300/500 (IEC), 300 (UL-CSA)
CV06G050_06000_□□	6	0,5	21	7,6	70	300/500 (IEC), 300 (UL-CSA)
CV06G075_06000_□□	6	0,75	19	8,5	90	300/500 (IEC), 300 (UL-CSA)
CV06G100_06000_□□	6	1	18	9,1	108	600/1000 (IEC), 1000 (UL-CSA)
CV06G150_06000_□□	6	1,5	16	10,8	156	600/1000 (IEC), 1000 (UL-CSA)
CV06G250_06000_□□	6	2,5	14	12,5	231	600/1000 (IEC), 1000 (UL-CSA)
CV07X035_06000_□□	7	0,35	22	5,1	41	300/500 (IEC), 300 (UL-CSA)
CV07X050_06000_□□	7	0,5	21	8	84	300/500 (IEC), 300 (UL-CSA)
CV07G100_06000_□□	7	1	18	9,6	132	600/1000 (IEC), 1000 (UL-CSA)
CV07G150_06000_□□	7	1,5	16	11	181	600/1000 (IEC), 1000 (UL-CSA)
CV07G250_06000_□□	7	2,5	14	12,7	269	600/1000 (IEC), 1000 (UL-CSA)
CV07G400_06000_□□	7	4	12	15,3	380	600/1000 (IEC), 1000 (UL-CSA)
CV07G600_06000_□□	7	6	10	17,3	527	600/1000 (IEC), 1000 (UL-CSA)
CV08X035_06000_□□	8	0,35	22	6,5	55	300/500 (IEC), 300 (UL-CSA)
CV08G050_06000_□□	8	0,5	21	8,6	91	300/500 (IEC), 300 (UL-CSA)
CV08G075_06000_□□	8	0,75	19	9,7	122	300/500 (IEC), 300 (UL-CSA)
CV08G100_06000_□□	8	1	18	10,4	141	600/1000 (IEC), 1000 (UL-CSA)
CV08G150_06000_□□	8	1,5	16	12,4	206	600/1000 (IEC), 1000 (UL-CSA)
CV08G250_06000_□□	8	2,5	14	14,6	308	600/1000 (IEC), 1000 (UL-CSA)
CV10X035_06000_□□	10	0,35	22	7,5	71	300/500 (IEC), 300 (UL-CSA)
CV10G050_06000_□□	10	0,5	21	9,6	113	300/500 (IEC), 300 (UL-CSA)
CV10G075_06000_□□	10	0,75	19	11	145	300/500 (IEC), 300 (UL-CSA)
CV10G100_06000_□□	10	1	18	11,7	177	600/1000 (IEC), 1000 (UL-CSA)

Codice Code	Numero di conduttori Number of conductors	Sezione Size [mm ²]	Sezione Size [AWG]	Diametro Diameter [mm]	Peso Weight [kg/km]	Tensione Voltage [V]
CV10G150_06000_□□	10	1,5	16	14,2	262	600/1000 (IEC), 1000 (UL-CSA)
CV10G250_06000_□□	10	2,5	14	16,9	400	600/1000 (IEC), 1000 (UL-CSA)
CV12X035_06000_□□	12	0,35	22	8,3	86	300/500 (IEC), 300 (UL-CSA)
CV12G050_06000_□□	12	0,5	21	11	147	300/500 (IEC), 300 (UL-CSA)
CV12G075_06000_□□	12	0,75	19	12,4	198	300/500 (IEC), 300 (UL-CSA)
CV12G100_06000_□□	12	1	18	13,2	239	600/1000 (IEC), 1000 (UL-CSA)
CV12G150_06000_□□	12	1,5	16	15,9	346	600/1000 (IEC), 1000 (UL-CSA)
CV12G250_06000_□□	12	2,5	14	20,1	560	600/1000 (IEC), 1000 (UL-CSA)
CV14X035_06000_□□	14	0,35	22	7,7	82	300/500 (IEC), 300 (UL-CSA)
CV14G050_06000_□□	14	0,5	21	9,9	128	300/500 (IEC), 300 (UL-CSA)
CV14G075_06000_□□	14	0,75	19	11,3	167	300/500 (IEC), 300 (UL-CSA)
CV14G100_06000_□□	14	1	18	12,1	206	600/1000 (IEC), 1000 (UL-CSA)
CV14G150_06000_□□	14	1,5	16	14,6	305	600/1000 (IEC), 1000 (UL-CSA)
CV14G250_06000_□□	14	2,5	14	17,4	472	600/1000 (IEC), 1000 (UL-CSA)
CV16X035_06000_□□	16	0,35	22	8,1	92	300/500 (IEC), 300 (UL-CSA)
CV16G050_06000_□□	16	0,5	21	10,3	143	300/500 (IEC), 300 (UL-CSA)
CV16G075_06000_□□	16	0,75	19	11,8	204	300/500 (IEC), 300 (UL-CSA)
CV16G100_06000_□□	16	1	18	12,7	232	600/1000 (IEC), 1000 (UL-CSA)
CV16G150_06000_□□	16	1,5	16	15,3	345	600/1000 (IEC), 1000 (UL-CSA)
CV16G250_06000_□□	16	2,5	14	18,3	534	600/1000 (IEC), 1000 (UL-CSA)
CV18X035_06000_□□	18	0,35	22	8,4	102	300/500 (IEC), 300 (UL-CSA)
CV18G050_06000_□□	18	0,5	21	11,2	173	300/500 (IEC), 300 (UL-CSA)
CV18G075_06000_□□	18	0,75	19	12,6	257	300/500 (IEC), 300 (UL-CSA)
CV18G100_06000_□□	18	1	18	13,5	291	600/1000 (IEC), 1000 (UL-CSA)
CV18G150_06000_□□	18	1,5	16	16	418	600/1000 (IEC), 1000 (UL-CSA)
CV18G250_06000_□□	18	2,5	14	20,1	670	600/1000 (IEC), 1000 (UL-CSA)
CV25X035_06000_□□	25	0,35	22	10,2	144	300/500 (IEC), 300 (UL-CSA)
CV25G050_06000_□□	25	0,5	21	13,8	252	300/500 (IEC), 300 (UL-CSA)
CV25G075_06000_□□	25	0,75	19	15,4	345	300/500 (IEC), 300 (UL-CSA)
CV25G100_06000_□□	25	1	18	16,3	459	600/1000 (IEC), 1000 (UL-CSA)
CV25G150_06000_□□	25	1,5	16	19,8	598	600/1000 (IEC), 1000 (UL-CSA)
CV25G250_06000_□□	25	2,5	14	24,8	960	600/1000 (IEC), 1000 (UL-CSA)
CV41G100_06000_□□	41	1	18	20,7	658	600/1000 (IEC), 1000 (UL-CSA)

Composizione del codice - Code composition

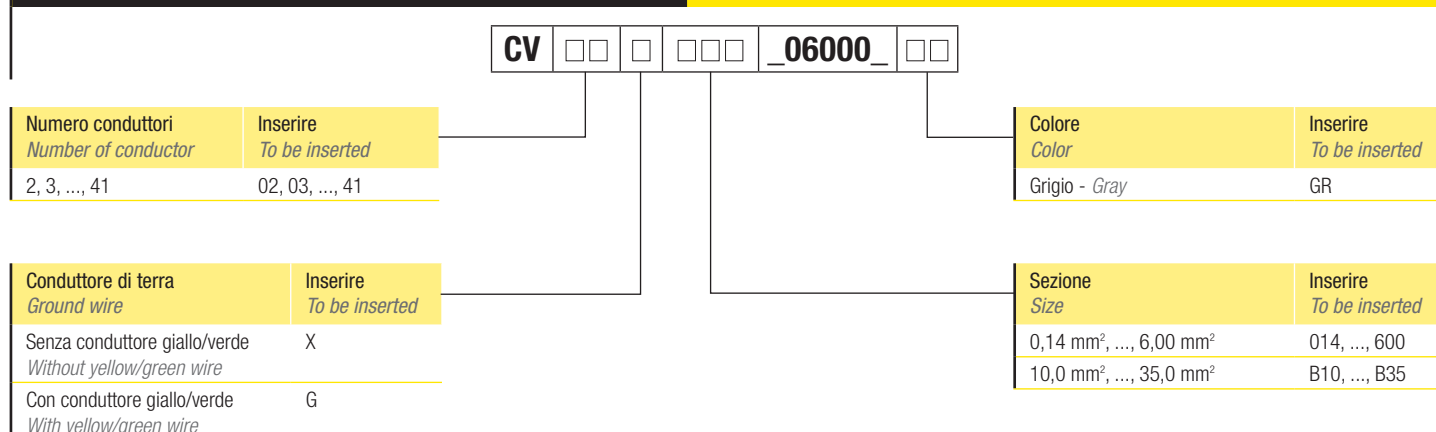

**SERIES
600S**

Cavi multipolari multinorma antiolio altamente flessibili



Multi-norm oil-resistant high flexible cables

Posa mobile, schermati - Dynamic application, shielded

cURus

RoHS

CE UK CA



Impiego - Use

Cavi schermati progettati per impiego mobile in catena porta cavi anche di elevata lunghezza (movimentazione continue su assi cartesiani); trovano impiego anche su robot antropomorfi per movimentazione in flessione torsione. Vengono normalmente utilizzati per l'equipaggiamento di apparecchiature destinate sia al mercato Europeo (CE) che ai mercati nord americani e canadesi. La speciale miscela in poliuretano della guaina esterna garantisce ottime prestazioni meccaniche, resistenza all'abrasione ed all'accelerazione oltre che una eccellente resistenza agli olii e fluidi industriali più utilizzati. La marcatura metrica stampigliata sulla guaina del cavo ne favorisce la lavorazione e l'installazione.

Shielded cables planned for mobile use on a cable holder chain, even with great length (continuous motion on Cartesian axis); they are used also on anthropomorphic robot for flexotorsion motion. They are normally used for equipments meant for the European (EC), North American and Canadian markets. The special polyurethane compound of the external jacket grants very good mechanical performance, abrasion and acceleration resistance, and a very good resistance to the most common industrial oils and fluids. The metric marked on the jacket allows an easier processing and installation of the cable.

Informazione. Si effettua, su richiesta, un servizio aggiuntivo di taglio a misura certificato UL ("Processed Wire").
Information. An additional UL certified cut-to-length service is carried out on request ("Processed Wire").

Dati tecnici - Technical data

Caratteristica - Characteristics	Valore/proprietà - Value/property
Conduttore <i>Conductor</i>	Trefolo flessibile in rame, cl.5/6 <i>Flexible copper strand, class 5/6</i>
Isolamento <i>Insulation</i>	TKblend®-L
Distinzione conduttori <i>Conductor distinction</i>	Sezioni <0,5 mm ² : colorati DIN 47100 Sezioni ≥0,5 mm ² : neri numerati + giallo/verde (a partire dai 3 conduttori) <i>Size <0,5 mm²: DIN 47100 colored</i> <i>Size ≥0,5 mm²: black numbered + yellow/green (beginning from 3 conductors)</i>
Riempitivi <i>Fillers</i>	Eventuali riempitivi centrali o laterali <i>Central or side fillers, if any</i>
Nastratura <i>Taping</i>	Nastro sintetico non igroscopico <i>Synthetic non-hygroscopic tape</i>
Schermatura <i>Shield</i>	Treccia di rame stagnato con ricopertura nom. 85% <i>Tinned copper braid, nom. coverage 85%</i>
Nastratura esterna <i>External taping</i>	Nastro sintetico non igroscopico <i>Synthetic non-hygroscopic tape</i>
Guaina <i>Jacket</i>	Miscela di poliuretano antiolio e antifiama, colore grigio RAL 7001. Marcatura metrica. <i>Polyurethane compound, oil-resistant and flame-resistant, RAL 7001 gray color. Metric marking.</i>
Temperatura di esercizio <i>Temperature range</i>	-30°C, +80°C (posa mobile); -40°C, +80°C (posa fissa) <i>-30°C, +80°C (dynamic); -40°C, +80°C (fixed)</i>
Tensione nominale <i>Voltage rating</i>	Sezioni ≤0,75 mm ² : 300 V (UL-CSA), 300/500 V (IEC) Sezioni > 0,75 mm ² : 1000 V (UL-CSA), 600/1000 V (IEC) <i>Size ≤0,75 mm²: 300 V (UL-CSA), 300/500 V (IEC)</i> <i>Size >0,75 mm²: 1000 V (UL-CSA), 600/1000 V (IEC)</i>
Tensione di prova <i>Test voltage</i>	2000/4000 V
Velocità <i>Speed</i>	220 m/min*
Accelerazione <i>Acceleration</i>	10 m/s ²
Raggio di curvatura <i>Bending radius</i>	5 volte diametro esterno del cavo <i>5 x cable outer diameter</i>
Riferimenti normativi costruttivi <i>Standards of construction</i>	Flame res.: IEC 60332-1, CEI 20-35, UL VW-1, CSA FT1 I Oil res.: VDE 0472 (part 803/B), UL 1581 I Other: CEI EN 60228, EN 60228, UL 758, CSA AWM I/II A/B, cURus AWM Style 20940 or 21209
Riferimenti normativi d'impiego <i>Standards of use</i>	ANSI/NFPA 79, UL 508a, CSA C22.1 (CE Code), CSA C22.2 No.286, Style 20940 or 21209

* Per velocità superiori ai 220 m/min chiedere all'ufficio commerciale.

* For speed greater than 220 m/min ask the sales department.

Marcatura - Marking

TEKIMA 0600S - CE 4G6 mm² 80°C 1000 V CEI 20-35 IEC 60332-1 - c(UR)us E314444 AWM 20940 4x10 AWG 80°C 1000 V VW-1 Class I/II A/B FT1 - (prod.reference) = (metric) =

Codifiche e dimensioni - Coding and dimensions

Codice <i>Code</i>	Numero di conduttori <i>Number of conductors</i>	Sezione <i>Size [mm²]</i>	Sezione <i>Size [AWG]</i>	Diametro <i>Diameter [mm]</i>	Peso <i>Weight [kg/km]</i>	Tensione <i>Voltage [V]</i>
CV02X035_0600S_□□	2	0,35	22	4,9	31	300/500 (IEC), 300 (UL-CSA)
CV02X050_0600S_□□	2	0,5	21	6,4	49	300/500 (IEC), 300 (UL-CSA)
CV02X075_0600S_□□	2	0,75	19	6,1	53,2	300/500 (IEC), 300 (UL-CSA)
CV02X100_0600S_□□	2	1	18	6,7	65	600/1000 (IEC), 1000 (UL-CSA)
CV02X150_0600S_□□	2	1,5	16	7,4	80	600/1000 (IEC), 1000 (UL-CSA)
CV02X250_0600S_□□	2	2,5	14	9,9	128	600/1000 (IEC), 1000 (UL-CSA)
CV03X035_0600S_□□	3	0,35	22	5,1	34	300/500 (IEC), 300 (UL-CSA)
CV03G050_0600S_□□	3	0,5	21	6	50	300/500 (IEC), 300 (UL-CSA)
CV03G075_0600S_□□	3	0,75	19	7,1	74	300/500 (IEC), 300 (UL-CSA)
CV03G100_0600S_□□	3	1	18	7,6	88	600/1000 (IEC), 1000 (UL-CSA)
CV03G150_0600S_□□	3	1,5	16	9	108	600/1000 (IEC), 1000 (UL-CSA)
CV03G250_0600S_□□	3	2,5	14	10,4	177	600/1000 (IEC), 1000 (UL-CSA)
CV04X035_0600S_□□	4	0,35	22	5,6	46	300/500 (IEC), 300 (UL-CSA)
CV04G050_0600S_□□	4	0,5	21	7	69	300/500 (IEC), 300 (UL-CSA)
CV04G075_0600S_□□	4	0,75	19	7,7	96	300/500 (IEC), 300 (UL-CSA)
CV04G100_0600S_□□	4	1	18	8,1	100	600/1000 (IEC), 1000 (UL-CSA)
CV04G150_0600S_□□	4	1,5	16	9,4	135	600/1000 (IEC), 1000 (UL-CSA)
CV04G250_0600S_□□	4	2,5	14	11,2	211	600/1000 (IEC), 1000 (UL-CSA)
CV04G400_0600S_□□	4	4	12	12,6	280	600/1000 (IEC), 1000 (UL-CSA)
CV04G600_0600S_□□	4	6	10	13,9	370	600/1000 (IEC), 1000 (UL-CSA)
CV04GB10_0600S_□□	4	10	8	19,3	653	600/1000 (IEC), 1000 (UL-CSA)
CV04GB16_0600S_□□	4	16	6	22,4	955	600/1000 (IEC), 1000 (UL-CSA)
CV04GB25_0600S_□□	4	25	4	27,3	1463	600/1000 (IEC), 1000 (UL-CSA)
CV04GB35_0600S_□□	4	35	2	30,1	1726	600/1000 (IEC), 1000 (UL-CSA)
CV05X035_0600S_□□	5	0,35	22	5,8	48	300/500 (IEC), 300 (UL-CSA)
CV05G050_0600S_□□	5	0,5	21	7,6	75	300/500 (IEC), 300 (UL-CSA)
CV05G075_0600S_□□	5	0,75	19	8,3	100	300/500 (IEC), 300 (UL-CSA)
CV05G100_0600S_□□	5	1	18	9	124	600/1000 (IEC), 1000 (UL-CSA)
CV05G150_0600S_□□	5	1,5	16	9,7	152	600/1000 (IEC), 1000 (UL-CSA)
CV05G250_0600S_□□	5	2,5	14	12,2	525	600/1000 (IEC), 1000 (UL-CSA)
CV05G400_0600S_□□	5	4	12	14,2	346	600/1000 (IEC), 1000 (UL-CSA)
CV05G600_0600S_□□	5	6	10	16,2	474	600/1000 (IEC), 1000 (UL-CSA)
CV05GB10_0600S_□□	5	10	8	22,9	819	600/1000 (IEC), 1000 (UL-CSA)
CV06X035_0600S_□□	6	0,35	22	6,2	54	300/500 (IEC), 300 (UL-CSA)
CV06G050_0600S_□□	6	0,5	21	8,1	86	300/500 (IEC), 300 (UL-CSA)
CV06G075_0600S_□□	6	0,75	19	9,1	107	300/500 (IEC), 300 (UL-CSA)
CV06G100_0600S_□□	6	1	18	9,7	134	600/1000 (IEC), 1000 (UL-CSA)
CV06G150_0600S_□□	6	1,5	16	11,4	186	600/1000 (IEC), 1000 (UL-CSA)
CV06G250_0600S_□□	6	2,5	14	13,3	273	600/1000 (IEC), 1000 (UL-CSA)
CV07X035_0600S_□□	7	0,35	22	5,7	54	300/500 (IEC), 300 (UL-CSA)
CV07X050_0600S_□□	7	0,5	21	8	96	300/500 (IEC), 300 (UL-CSA)
CV07X150_0600S_□□	7	1,5	16	11	203	600/1000 (IEC), 1000 (UL-CSA)
CV07G400_0600S_□□	7	4	12	16	431	600/1000 (IEC), 1000 (UL-CSA)
CV07G600_0600S_□□	7	6	10	18,2	602	600/1000 (IEC), 1000 (UL-CSA)
CV08X035_0600S_□□	8	0,35	22	7,2	72	300/500 (IEC), 300 (UL-CSA)
CV08G050_0600S_□□	8	0,5	21	9,2	116	300/500 (IEC), 300 (UL-CSA)
CV08G075_0600S_□□	8	0,75	19	10,4	154	300/500 (IEC), 300 (UL-CSA)
CV08G100_0600S_□□	8	1	18	11	185	600/1000 (IEC), 1000 (UL-CSA)
CV08G150_0600S_□□	8	1,5	16	13,2	250	600/1000 (IEC), 1000 (UL-CSA)
CV08G250_0600S_□□	8	2,5	14	15,3	360	600/1000 (IEC), 1000 (UL-CSA)
CV10X035_0600S_□□	10	0,35	22	8	88	300/500 (IEC), 300 (UL-CSA)
CV10G050_0600S_□□	10	0,5	21	10,2	141	300/500 (IEC), 300 (UL-CSA)
CV10G075_0600S_□□	10	0,75	19	11,6	177	300/500 (IEC), 300 (UL-CSA)
CV10G100_0600S_□□	10	1	18	12,4	211	600/1000 (IEC), 1000 (UL-CSA)
CV10G150_0600S_□□	10	1,5	16	14,9	313	600/1000 (IEC), 1000 (UL-CSA)
CV10G250_0600S_□□	10	2,5	14	17,6	459	600/1000 (IEC), 1000 (UL-CSA)
CV12X035_0600S_□□	12	0,35	22	9	11	300/500 (IEC), 300 (UL-CSA)

Cavi multipolari per posa mobile - Cables for dynamic applications

Codice Code	Numero di conduttori Number of conductors	Sezione Size [mm ²]	Sezione Size [AWG]	Diametro Diameter [mm]	Peso Weight [kg/km]	Tensione Voltage [V]
CV12G050_0600S_□□	12	0,5	21	11,4	177	300/500 (IEC), 300 (UL-CSA)
CV12G075_0600S_□□	12	0,75	19	13	239	300/500 (IEC), 300 (UL-CSA)
CV12G100_0600S_□□	12	1	18	14	285	600/1000 (IEC), 1000 (UL-CSA)
CV12G150_0600S_□□	12	1,5	16	16,6	406	600/1000 (IEC), 1000 (UL-CSA)
CV12G250_0600S_□□	12	2,5	14	18,3	512	600/1000 (IEC), 1000 (UL-CSA)
CV14X035_0600S_□□	14	0,35	22	8,2	100	300/500 (IEC), 300 (UL-CSA)
CV14G050_0600S_□□	14	0,5	21	10,5	157	300/500 (IEC), 300 (UL-CSA)
CV14G075_0600S_□□	14	0,75	19	11,9	200	300/500 (IEC), 300 (UL-CSA)
CV14G100_0600S_□□	14	1	18	12,8	252	600/1000 (IEC), 1000 (UL-CSA)
CV14G150_0600S_□□	14	1,5	16	15,3	357	600/1000 (IEC), 1000 (UL-CSA)
CV14G250_0600S_□□	14	2,5	14	18,3	553	600/1000 (IEC), 1000 (UL-CSA)
CV16X035_0600S_□□	16	0,35	22	8,7	117	300/500 (IEC), 300 (UL-CSA)
CV16G050_0600S_□□	16	0,5	21	10,9	175	300/500 (IEC), 300 (UL-CSA)
CV16G075_0600S_□□	16	0,75	19	12,6	233	300/500 (IEC), 300 (UL-CSA)
CV16G100_0600S_□□	16	1	18	13,4	280	600/1000 (IEC), 1000 (UL-CSA)
CV16G150_0600S_□□	16	1,5	16	16,1	401	600/1000 (IEC), 1000 (UL-CSA)
CV16G250_0600S_□□	16	2,5	14	19,4	616	600/1000 (IEC), 1000 (UL-CSA)
CV18X035_0600S_□□	18	0,35	22	9,3	131	300/500 (IEC), 300 (UL-CSA)
CV18G050_0600S_□□	18	0,5	21	11,4	191	300/500 (IEC), 300 (UL-CSA)
CV18G075_0600S_□□	18	0,75	19	13,1	293	300/500 (IEC), 300 (UL-CSA)
CV18G100_0600S_□□	18	1	18	14,2	334	600/1000 (IEC), 1000 (UL-CSA)
CV18G150_0600S_□□	18	1,5	16	17,1	478	600/1000 (IEC), 1000 (UL-CSA)
CV18G250_0600S_□□	18	2,5	14	20,4	702	600/1000 (IEC), 1000 (UL-CSA)
CV25X035_0600S_□□	25	0,35	22	10,6	168	300/500 (IEC), 300 (UL-CSA)
CV25G050_0600S_□□	25	0,5	21	14,4	298	300/500 (IEC), 300 (UL-CSA)
CV25G075_0600S_□□	25	0,75	19	16	397	300/500 (IEC), 300 (UL-CSA)
CV25G100_0600S_□□	25	1	18	17	513	600/1000 (IEC), 1000 (UL-CSA)
CV25G150_0600S_□□	25	1,5	16	20	685	600/1000 (IEC), 1000 (UL-CSA)
CV25G250_0600S_□□	25	2,5	14	24,9	987	600/1000 (IEC), 1000 (UL-CSA)

Composizione del codice - Code composition

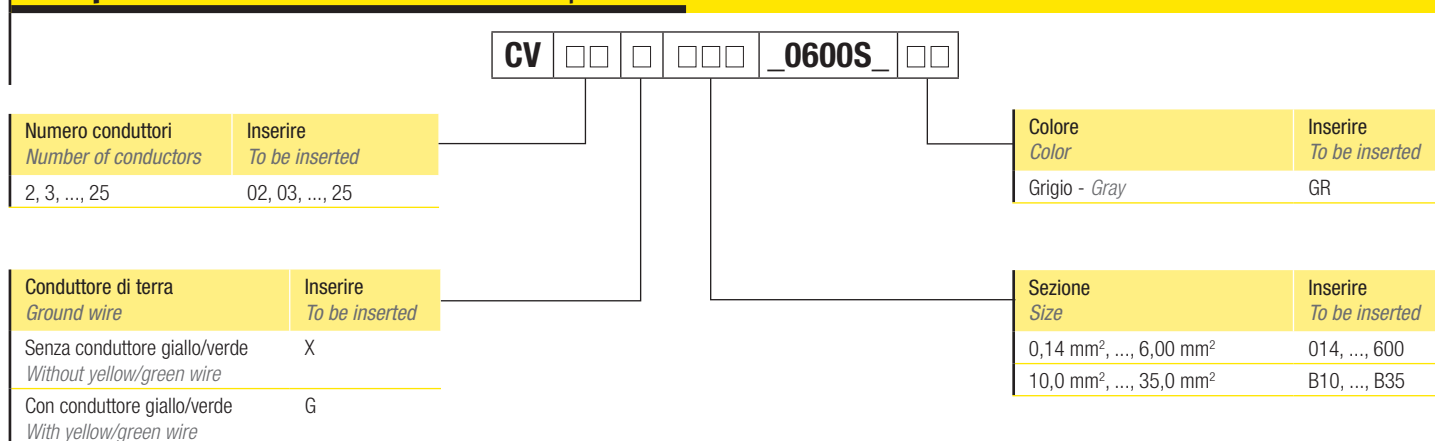

**SERIES
600S**

Cavi multinorma antiolio altamente flessibili per servomotori



Multi-norm oil-resistant high flexible cables for servo motors

Posa mobile, schermati - Dynamic application, shielded

UL US



RoHS

CE UK
CA



Impiego - Use

Cavi schermati progettati per impiego mobile in catena porta cavi anche di elevata lunghezza (movimentazione continue su assi cartesiani); trovano impiego anche su robot antropomorfi per movimentazione in flessione torsione. Vengono normalmente utilizzati per l'equipaggiamento di apparecchiature destinate sia al mercato Europeo (CE) che ai mercati nord americani e canadesi. La speciale miscela in poliuretano della guaina esterna garantisce ottime prestazioni meccaniche, resistenza all'abrasione oltre che una eccellente resistenza agli olii e fluidi industriali più utilizzati. La marcatura metrica stampigliata sulla guaina del cavo ne favorisce la lavorazione e l'installazione.

Shielded cables planned for mobile use on a cable holder chain, even with great length (continuous motion on Cartesian axis); they are used also on anthropomorphic robot for flexotorsion motion. They are normally used for equipments meant for the European (EC), North American and Canadian markets. The special polyurethane compound of the external jacket grants very good mechanical performance, abrasion resistance and a very good resistance to the most common industrial oils and fluids. The metric marked on the jacket allows an easier processing and installation of the cable.

Informazione. Si effettua, su richiesta, un servizio aggiuntivo di taglio a misura certificato UL ("Processed Wire").

Information. An additional UL certified cut-to-length service is carried out on request ("Processed Wire").

Dati tecnici - Technical data

Caratteristica - Characteristics	Valore/proprietà - Value/property
Conduttore <i>Conductor</i>	Trefolo flessibile in rame, cl.5/6 <i>Flexible copper strand, class 5/6</i>
Isolamento <i>Insulation</i>	TKblend®-L
Distinzione conduttori <i>Conductor distinction</i>	Potenza: neri numerati + giallo/verde. Segnale: 1 coppia: bianco e nero, >1 coppia: neri numerati <i>Power: black numbered + yellow/green. Signal: 1 pair: white and black. >1 pair: black numbered</i>
Riempitivi <i>Fillers</i>	Eventuali riempitivi centrali o laterali <i>Central or side fillers, if any</i>
Schermatura coppie <i>Pairs shield</i>	Treccia di rame stagnato con ricopertura nom. 80% <i>Tinned copper braid, nom. coverage 80%</i>
Nastratura coppie <i>Pairs taping</i>	Tessuto non tessuto <i>Non-woven tape</i>
Nastratura totale <i>Total taping</i>	Nastro sintetico non igroscopico <i>Synthetic non-hygroscopic tape</i>
Schermatura <i>Shield</i>	Treccia di rame stagnato, ricopertura nom. 85% <i>Tinned copper braid, nom. coverage 85%</i>
Guaina <i>Jacket</i>	Miscela di poliuretano antiolio e antifiama, colore arancione Desina RAL 2003. Marcatura metrica. <i>Polyurethane compound, oil-resistant and flame-resistant, Desina RAL 2003 orange color. Metric marking.</i>
Temperatura di esercizio <i>Temperature range</i>	-30°C, +80°C (posa mobile); -40°C, +80°C (posa fissa) <i>-30°C, +80°C (dynamic); -40°C, +80°C (fixed)</i>
Tensione nominale <i>Voltage rating</i>	1000 V (UL-CSA), 600/1000 V (IEC)
Tensione di prova <i>Test voltage</i>	2000/4000 V
Velocità <i>Speed</i>	220 m/min*
Accelerazione <i>Acceleration</i>	10 m/s ²
Raggio di curvatura <i>Bending radius</i>	5 volte diametro esterno del cavo <i>5 x cable outer diameter</i>
Riferimenti normativi costruttivi <i>Standards of construction</i>	Flame res.: IEC 60332-1, CEI 20-35, UL VW-1, CSA FT1 Oil res.: VDE 0472 (part 803/B), UL 1581 Other: CEI EN 60228, EN 60228, UL 758, CSA AWM I/II A/B, cURus AWM Style 20234
Riferimenti normativi d'impiego <i>Standards of use</i>	ANSI/NFPA 79, UL 508a, CSA C22.1 (CE Code), CSA C22.2 No.286, Style 20234

* Per velocità superiori ai 220 m/min chiedere all'ufficio commerciale.

* For speed greater than 220 m/min ask the sales department.

Marcatura - Marking

TEKIMA 0600S – CE (4G1,5+(2x1)) mm² 80°C 1000 V CEI 20-35 IEC 60332-1 – c(UL)us E314444 AWM Style 20234 (4x16+(2x18)) AWG 80°C 1000 V VW-1 Class I/II A/B FT1 – (prod.reference) = (metric) =

Codifiche e dimensioni - Coding and dimensions

Codice <i>Code</i>	N° conduttori x sezione <i>Num. conductors x Size [mm²]</i>	N° conduttori x sezione <i>Num. conductors x Size [AWG]</i>	Diametro <i>Diameter [mm]</i>	Peso <i>Weight [kg/km]</i>
CVFM0001_0600S_D2	(4G1,5+(2x1))	(4x16+(2x18))	12,3	194
CVFM0002_0600S_D2	(4G1,5+(2x1,5))	(4x16+(2x16))	12,9	223
CVFM0003_0600S_D2	(4G1,5+2x(2x0,75))	(4x16+2x(2x19))	13,4	237

Codice Code	N° conduttori x sezione Num. conductors x Size [mm²]	N° conduttori x sezione Num. conductors x Size [AWG]	Diametro Diameter [mm]	Peso Weight [kg/km]
CVFM0004_0600S_D2	(4G1,5+2x(2x1))	(4x16+2x(2x18))	14,0	257
CVFM0005_0600S_D2	(4G2,5+(2x1))	(4x14+(2x18))	13,4	256
CVFM0006_0600S_D2	(4G2,5+(2x1,5))	(4x14+(2x16))	13,9	275
CVFM0007_0600S_D2	(4G2,5+2x(2x1))	(4x14+2x(2x18))	14,6	304
CVFM0008_0600S_D2	(4G2,5+2x(2x1,5))	(4x14+2x(2x16))	15,9	348
CVFM0026_0600S_D2	(4G4+(2x1))	(4x12+(2x18))	14,4	317
CVFM0010_0600S_D2	(4G4+(2x1,5))	(4x12+(2x16))	14,9	339
CVFM0011_0600S_D2	(4G4+2x(2x1))	(4x12+2x(2x18))	16,2	374
CVFM0012_0600S_D2	(4G4+2x(2x1,5))	(4x12+2x(2x16))	17,6	423
CVFM0025_0600S_D2	(4G6+(2x1))	(4x10+(2x18))	15,8	404
CVFM0013_0600S_D2	(4G6+(2x1,5))	(4x10+(2x16))	16,3	423
CVFM0015_0600S_D2	(4G6+2x(2x1,5))	(4x10+2x(2x16))	19,0	533
CVFM0016_0600S_D2	(4G10+(2x1))	(4x8+(2x18))	20,3	685
CVFM0017_0600S_D2	(4G10+(2x1,5))	(4x8+(2x16))	20,7	708
CVFM0018_0600S_D2	(4G10+2x(2x1,5))	(4x8+2x(2x16))	23,4	820
CVFM0019_0600S_D2	(4G16+(2x1))	(4x6+(2x18))	23,1	860
CVFM0020_0600S_D2	(4G16+(2x1,5))	(4x6+(2x16))	23,6	897
CVFM0021_0600S_D2	(4G16+2x(2x1,5))	(4x6+2x(2x16))	25,4	986
CVFM0022_0600S_D2	(4G25+(2x1,5))	(4x4+(2x16))	17,1	1298
CVFM0023_0600S_D2	(4G25+2x(2x1,5))	(4x4+2x(2x16))	29,0	1427
CVFM0024_0600S_D2	(4G35+(2x1,5))	(4x2+(2x16))	31,8	1841
CVFM0027_0600S_D2	(4G35+2x(2x1,5))	(4x2+2x(2x16))	33,8	1977
CVFM0028_0600S_D2	(4G50+2x(2x2,5))	(4x1+2x(2x14))	36,5	2883

Composizione del codice - Code composition

CVFM □ □ □ □ _0600S_ □ □	Colore Color Arancione Desina Desina orange	Inserire To be inserted D2
Formazione Construction Codice identificativo della particolare formazione del cavo. Identifier code of the special cable construction.		

**SERIES
600S**

Cavi multinorma antiolio altamente flessibili per encoder e resolver



Multi-norm oil-resistant high flexible cables for encoders and resolvers

Posa mobile, schermati - Dynamic application, shielded

UL US



RoHS

CE UK CA



Impiego - Use

Cavi schermati progettati per impiego mobile in catena porta cavi anche di elevata lunghezza (movimentazione continue su assi cartesiani); trovano impiego anche su robot antropomorfi per movimentazione in flessione torsione. Vengono normalmente utilizzati per l'equipaggiamento di apparecchiature destinate sia al mercato Europeo (CE) che ai mercati nord americani e canadesi. La speciale miscela in poliuretano della guaina esterna garantisce ottime prestazioni meccaniche e resistenza all'abrasione oltre che una eccellente resistenza agli olii e fluidi industriali più utilizzati. La marcatura metrica stampigliata sulla guaina del cavo ne favorisce la lavorazione e l'installazione.

Shielded cables planned for mobile use on a cable holder chain, even with great length (continuous motion on Cartesian axis); they are used also on anthropomorphic robot for flexotorsion motion. They are normally used for equipments meant for the European (EC), North American and Canadian markets. The special polyurethane compound of the external jacket grants very good mechanical performance, abrasion resistance and a very good resistance to the most common industrial oils and fluids. The metric marked on the jacket allows an easier processing and installation of the cable.

Informazione. Si effettua, su richiesta, un servizio aggiuntivo di taglio a misura certificato UL ("Processed Wire").

Information. An additional UL certified cut-to-length service is carried out on request ("Processed Wire").

Dati tecnici - Technical data

Caratteristica - Characteristics	Valore/proprietà - Value/property
Conduttore <i>Conductor</i>	Trefolo flessibile in rame, cl.5/6 <i>Flexible copper strand, class 5/6</i>
Isolamento <i>Insulation</i>	TKblend®-L
Distinzione conduttori <i>Conductor distinction</i>	Vedi tabella "Codifiche e dimensioni" <i>See "Coding and dimensions" table below</i>
Riempitivi <i>Fillers</i>	Eventuali riempitivi centrali o laterali <i>Central or side fillers, if any</i>
Nastratura <i>Taping</i>	Nastro sintetico non igroscopico <i>Synthetic non-hygroscopic tape</i>
Schermatura <i>Shield</i>	Treccia di rame stagnato con ricopertura nom. 85% <i>Tinned copper braid, nom. coverage 85%</i>
Guaina <i>Jacket</i>	Miscela di poliuretano antiolio e antifiamma, colore verde Desina RAL 6018. Marcatura metrica. <i>Polyurethane compound, oil-resistant and flame-resistant, Desina RAL 6018 green color. Metric marking.</i>
Temperatura di esercizio <i>Temperature range</i>	-30°C, +80°C (posa mobile); -40°C, +80°C (posa fissa) <i>-30°C, +80°C (dynamic); -40°C, +80°C (fixed)</i>
Tensione nominale <i>Voltage rating</i>	300 V (UL-CSA), 300/500 V (IEC)
Tensione di prova <i>Test voltage</i>	2000/4000 V
Velocità <i>Speed</i>	220 m/min*
Accelerazione <i>Acceleration</i>	10 m/s ²
Raggio di curvatura <i>Bending radius</i>	5 volte diametro esterno del cavo <i>5 x cable outer diameter</i>
Riferimenti normativi costruttivi <i>Standards of construction</i>	Flame res.: IEC 60332-1, CEI 20-35, UL VW-1, CSA FT1 Oil res.: VDE 0472 (part 803/B), UL 1581 Other: CEI EN 60228, EN 60228, UL 758, CSA AWM I/II A/B, cURus AWM Style 20233
Riferimenti normativi d'impiego <i>Standards of use</i>	ANSI/NFPA 79, UL 508a, CSA C22.1 (CE Code), CSA C22.2 No.286, Style 20233 or Style 21209

Marcatura - Marking

TEKIMA 0600S – CE (3x2x0,25+2x0,5) mm² 80°C 300/500 V CEI 20-35 IEC 60332-1 – c(UR)us E314444 AWM Style 20233 (3x2x22+2x21) AWG 80°C 300V VW-1 Class I/II A/B FT1 – (prod.reference) = (metric) =

Codifiche e dimensioni - Coding and dimensions

Codice <i>Code</i>	N° conduttori x sezione <i>Num. conductors x Size [mm²]</i>	N° conduttori x sezione <i>Num. conductors x Size [AWG]</i>	Diametro <i>Diameter [mm]</i>	Peso <i>Weight [kg/km]</i>	Colorazioni disponibili ⁽²⁾ (Vedi appendice) <i>Available colors ⁽²⁾</i> (See appendix)
CVFS0001_0600S_D1	(2x2x0,14)	(2x2x26)	6,1	37	Control Techniques
CVFS0002_0600S_D1	(2x2x0,14)	(2x2x26)	6,1	37	DIN 47100
CVFS0003_0600S_D1	(2x2x0,35)	(2x2x22)	7,10	58	Tipo 10-P
CVFS0004_0600S_D1	(3x2x0,35)	(3x2x22)	7,20	68	Tipo 1-P
CVFS0018_0600S_D1	(3x2x0,35)	(3x2x22)	7,20	68	Tipo 1-C

Cavi multipolari per posa mobile - Cables for dynamic applications

Codice Code	N° conduttori x sezione Num. conductors x Size [mm²]	N° conduttori x sezione Num. conductors x Size [AWG]	Diametro Diameter [mm]	Peso Weight [kg/km]	Colorazioni disponibili ⁽²⁾ (Vedi appendice) Available colors ⁽²⁾ (See appendix)
CVFS0019_0600S_D1	(3x2x0,35)	(3x2x22)	7,20	68	Tipo 1-T
CVFS0005_0600S_D1	(6x2x0,35)	(6x2x22)	9,60	105	Tipo 1-P
CVFS0021_0600S_D1	(6x2x0,35)	(6x2x22)	9,60	105	Tipo 1-C
CVFS0022_0600S_D1	(6x2x0,35)	(6x2x22)	9,60	105	Tipo 1-T
CVFS0006_0600S_D1	(3x2x0,35+2x0,5)	(3x2x22+2x21)	8,60	88	DIN 47100
CVFS0023_0600S_D1	(3x2x0,35+2x0,5)	(3x2x22+2x21)	8,60	88	Tipo 2-C
CVFS0007_0600S_D1	(3x2x0,35+3x0,35)	(3x2x22+3x22)	7,90	76	Tipo 3-P
CVFS0008_0600S_D1	(4x2x0,25+2x1)	(4x2x24+2x18)	9,00	109	DIN 47100
CVFS0024_0600S_D1	(4x2x0,25+2x1)	(4x2x24+2x18)	9,00	109	Tipo 4-C
CVFS0009_0600S_D1	(4x2x0,35+4x0,5)	(4x2x22+4x21)	9,20	119	Tipo 5-P
CVFS0010_0600S_D1	(5x0,5+1x2x0,25)	(5x21+1x2x24)	7,60	81	DIN 47100
CVFS0020_0600S_D1 ⁽¹⁾	(4x(2x0,35))	(4x(2x22))	11,00	159	Tipo 1-P
CVFS0025_0600S_D1 ⁽¹⁾	(4x(2x0,35))	(4x(2x22))	11,00	159	Tipo 1-C
CVFS0026_0600S_D1 ⁽¹⁾	(4x(2x0,35))	(4x(2x22))	11,00	159	Tipo 1-T
CVFS0011_0600S_D1 ⁽¹⁾	(6x(2x0,35))	(6x(2x22))	13,00	214	Tipo 1-P
CVFS0027_0600S_D1 ⁽¹⁾	(6x(2x0,35))	(6x(2x22))	13,00	214	Tipo 1-C
CVFS0012_0600S_D1	(2x0,35+8x0,35)	(2x22+8x22)	9,30	110	Tipo 7-P
CVFS0013_0600S_D1	(3x(2x0,14)+2x0,5)	(3x(2x26)+2x21)	8,30	90	DIN 47100
CVFS0028_0600S_D1	(3x(2x0,14)+2x0,5)	(3x(2x26)+2x21)	8,30	90	Tipo 8-C
CVFS0014_0600S_D1	(3x(2x0,14)+2x1)	(3x(2x26)+2x18)	8,60	100	DIN 47100
CVFS0029_0600S_D1	(3x(2x0,14)+2x1)	(3x(2x26)+2x18)	8,60	100	Tipo 8-C
CVFS0015_0600S_D1	(3x(2x0,14)+2x0,5+4x0,14)	(3x(2x26)+2x21+4x26)	9,30	111	Tipo 9-P
CVFS0016_0600S_D1	(3x(2x0,14)+2x0,5+4x0,14+4x0,25)	(3x(2x26)+2x21+4x26+4x24)	10,30	129	Tipo 9-P

(1) Resolver

(2) Il tipo di colorazione può variare in funzione della disponibilità di magazzino. Verificare con l'ufficio commerciale le colorazioni disponibili e l'eventuale fornitura secondo specifiche richieste.

(2) The colors can vary depending on the warehouse availability. Check with the sales dept. the colors available and the possible supply according to the required specifications.

Composizione del codice - Code composition

CVFS □□□□ _0600S_ □□	Colore Color Verde Desina Desina green	Inserire To be inserted D1
Formazione Construction Codice identificativo della particolare formazione del cavo. Identifier code of the special cable construction.		



Cavi per trasmissione dati
Data transmission cables

**SERIES
71000**

Cavi per trasmissione dati Profibus

Profibus data communication cables

Posa fissa - Fixed application



UL US



RoHS

CE UK
CA



Impiego - Use

Cavo per BUS di campo progettato per impiego fisso a bordo macchina. La doppia schermatura (elettrostatica ed elettromagnetica) lo rende adatto in ambienti con problematiche di compatibilità elettromagnetica (EMC). La speciale guaina a base di PVC garantisce buone prestazioni meccaniche, una buona resistenza all'abrasione ed una ottima resistenza ai più utilizzati oli lubrificanti e fluidi industriali.

Machine tool field BUS cable. The double shielding (electrostatic and electromagnetic) makes it suitable for environments with electromagnetic compatibility (EMC). The special PVC jacket grants very good mechanical performance, a good abrasion resistance and a very good resistance to the most common industrial oils and fluids.

Informazione. Si effettua, su richiesta, un servizio aggiuntivo di taglio a misura certificato UL ("Processed Wire").
Information. An additional UL certified cut-to-length service is carried out on request ("Processed Wire").

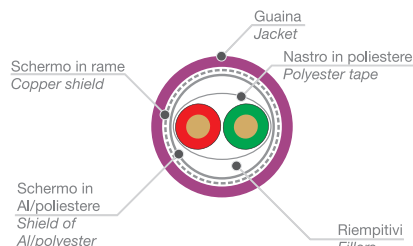

Dati tecnici - Technical data

Caratteristica - Characteristics	Valore/proprietà - Value/property
Conduttore <i>Conductor</i>	Rigido in rame rosso 1x0,64 mm <i>Rigid bare copper 1x0,64 mm</i>
Isolamento <i>Insulation</i>	TKblend®-L
Conduttori <i>Conductors</i>	Twistati, colorazione verde/rosso <i>Twisted, green/red colors</i>
Nastratura <i>Taping</i>	Nastro di poliestere <i>Polyester tape</i>
Schermatura <i>Shield</i>	Nastro alluminio/poliestere e treccia di rame stagnato con ricopertura nom. 85% <i>Aluminum/polyester tape and tinned copper braid, nom. coverage 85%</i>
Guaina <i>Jacket</i>	Miscela di PVC antiolio e antifiamma, colore viola Desina RAL 4001 <i>PVC compound, oil-resistant and flame-resistant, Desina RAL 4001 violet color</i>
Temperatura di esercizio <i>Temperature range</i>	-10°C, +80°C
Tensione nominale <i>Voltage rating</i>	300 V
Resistenza max. c.c. <i>Max DC resistance</i>	57,5 Ω/km
Resistenza max. c.c. di loop <i>Max DC loop resistance</i>	115,0 Ω/km
Impedenza caratteristica <i>Characteristic impedance</i>	150 Ω
Capacità <i>Capacitance</i>	29 nF/km @ 800 Hz
Resistenza dielettrica <i>Dielectric strength</i>	1500 V x 1 min (cond./cond. - cond./shield)
Raggio di curvatura <i>Bending radius</i>	15 volte diametro esterno del cavo <i>15 x cable outer diameter</i>
Riferimenti normativi costruttivi <i>Standards of construction</i>	Flame res.: IEC 60332-1, UL 1581 par. 1060-1061, CSA FT2 Oil res.: IEC 60811-2-1, EN 50363-4-1 Other: UL 1581, UL 758, CSA AWM I/II A/B, cURus AWM Style 20601
Riferimenti normativi d'impiego <i>Standards of use</i>	ANSI/NFPA 79, UL 508a, CSA C22.1 (CE Code), CSA C22.2 No.286, Style 20601

Marcatura - Marking

TEKIMA 71010 "PROFIBUS" – CE (1x2x0,35) mm² 80°C 300 V IEC 60332-1 – c(UR)us E314444 AWM Style 20601 (1x2x22) AWG 80°C 300 V AWM Class III A/B FT2 – 150 Ohm – (prod.reference) = (metric) =

Codifiche e dimensioni - Coding and dimensions

Codice <i>Code</i>	N. conduttori x sezione <i>Num. conductors x Size [mm²]</i>	N. conduttori x sezione <i>Num. conductors x Size [AWG]</i>	Diametro <i>Diameter [mm]</i>	Peso <i>Weight [kg/km]</i>
CVFD0001_71010_D3	((1x2x0,35))	((1x2x22))	7,8	78

SERIES
71100

Cavi per trasmissione dati Profibus

Profibus data communication cables

Posa mobile - Dynamic application



Impiego - Use

Cavo per BUS di campo progettato per posa mobile in catena portacavo. La doppia schermatura (elettrostatica ed elettromagnetica) lo rende adatto in ambienti con problematiche di compatibilità elettromagnetica (EMC). La speciale guaina a base di PVC garantisce buone prestazioni meccaniche, una buona resistenza all'abrasione ed una ottima resistenza ai più utilizzati olii lubrificanti e fluidi industriali.

Filed BUS cable planned for mobile installation on a cable holder chain. The double shielding (electrostatic and electromagnetic) makes it suitable for environments with electromagnetic compatibility (EMC). The special PVC jacket grants very good mechanical performance, a good abrasion resistance and a very good resistance to the most common industrial oils and fluids.

Informazione. Si effettua, su richiesta, un servizio aggiuntivo di taglio a misura certificato UL ("Processed Wire").

Information. An additional UL certified cut-to-length service is carried out on request ("Processed Wire").

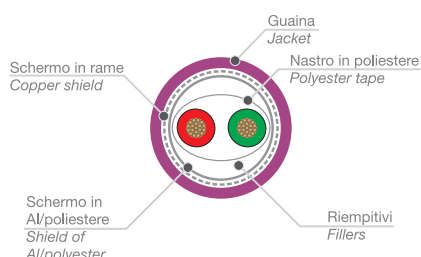

Dati tecnici - Technical data

Caratteristica - Characteristics	Valore/proprietà - Value/property
Conduttore <i>Conductor</i>	Rame ad elevata flessibilità 19X0,13 mm (0,25 mm ²) <i>Flexible copper strand 19X0,13 mm (0,25 mm²)</i>
Isolamento <i>Insulation</i>	TKblend®-L
Conduttori <i>Conductors</i>	Twistati, colorazione verde/rosso <i>Twisted, green/red colors</i>
Nastratura <i>Taping</i>	Nastro di poliestere <i>Polyester tape</i>
Schermatura <i>Shield</i>	Nastro alluminio/poliestere e treccia di rame stagnato con ricopertura nom. 85%, filo taglia guaina <i>Aluminum/polyester tape and tinned copper braid, nom. coverage 85%, rip cord</i>
Guaina <i>Jacket</i>	PVC antiolio, antifiama, colore viola Desina RAL 4001 <i>PVC, oil-resistant and flame-resistant, Desina RAL 4001 violet color</i>
Temperatura di esercizio <i>Temperature range</i>	-10°C, +80°C
Tensione nominale <i>Voltage rating</i>	30 V
Impedenza caratteristica <i>Characteristic impedance</i>	150 Ω
Capacità <i>Capacitance</i>	30 pF/m (cond./cond.), 50 pF/m (cond./shield)
Resistenza dielettrica <i>Dielectric strength</i>	500 V x 1 min (cond./cond. - cond./shield)
Raggio di curvatura <i>Bending radius</i>	10 volte diametro esterno del cavo <i>10 x cable outer diameter</i>
Velocità <i>Speed</i>	80 m/min
Accelerazione <i>Acceleration</i>	7 m/s ²
Riferimenti normativi costruttivi <i>Standards of construction</i>	Flame res.: IEC 60332-1, CEI 20-35, UL VW-1, CSA FT1 Oil res.: UL 1581 Other: CSA C22.2 No. 210, CSA AWM I/II A/B, cUR AWM Style 2919
Riferimenti normativi d'impiego <i>Standards of use</i>	CSA C22.1 (CE Code), CSA C22.2 No.286, Style 2919

Marcatura - Marking

TEKIMA 71100 "PROFIBUS" – CE (1x2x0,25) mm² 80°C 30 V CEI 20-35 IEC 60332-1 – c(UR)us E314444 AWM Style 2919 (1x2x24) AWG 80°C 30 V VW-1 Class I/II A/B FT1 – (prod. reference) = (metric) =

Codifiche e dimensioni - Coding and dimensions

Codice <i>Code</i>	N. conduttori x sezione <i>Num. conductors x Size [mm²]</i>	N. conduttori x sezione <i>Num. conductors x Size [AWG]</i>	Diametro <i>Diameter [mm]</i>	Peso <i>Weight [kg/km]</i>
CVFD0001_71100_D3	(1x2x0,25)	(1x2x24)	8,0	71

SERIES
71140

Cavi per trasmissione dati Profibus ad alte prestazioni



High performances Profibus data communication cables

Posa mobile - Dynamic application



Impiego - Use

Cavo per BUS di campo progettato per posa mobile in catena portacavo anche di elevata lunghezza (movimentazioni continue su assi cartesiani). La doppia schermatura (elettrostatica ed elettromagnetica) lo rende adatto in ambienti con problematiche di compatibilità elettromagnetica (EMC). La speciale guaina in poliuretano garantisce ottime prestazioni meccaniche, una ottima resistenza all'abrasione ed una ottima resistenza ai più utilizzati olii lubrificanti e fluidi industriali.

Field BUS cable planned for mobile installation on a cable holder chain, even with great length (continuous motion on Cartesian axis). The double shielding (electrostatic and electromagnetic) makes it suitable for environments with electromagnetic compatibility (EMC) problems. The special polyurethane jacket grants very good mechanical performance, a very good abrasion resistance and a very good resistance to the most common industrial oils and fluids.

Informazione. Si effettua, su richiesta, un servizio aggiuntivo di taglio a misura certificato UL ("Processed Wire").

Information. An additional UL certified cut-to-length service is carried out on request ("Processed Wire").

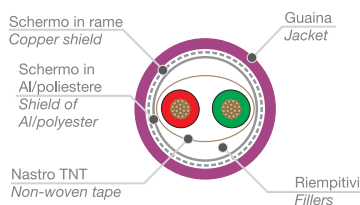

Dati tecnici - Technical data

Caratteristica - Characteristics	Valore/proprietà - Value/property
Conduttore <i>Conductor</i>	Rame ad elevata flessibilità 19X0,13 mm (0,25 mm ²) <i>Flexible copper strand 19X0,13 mm (0,25 mm²)</i>
Isolamento <i>Insulation</i>	TKblend®-L
Conduttori <i>Conductors</i>	Twistati, colorazione verde/rosso <i>Twisted, green/red colors</i>
Nastratura <i>Taping</i>	Nastro tessuto non tessuto <i>Non-woven tape</i>
Schermatura <i>Shield</i>	Nastro alluminio/poliestere e treccia di rame stagnato con ricopertura nom. 85% <i>Aluminum/polyester tape and tinned copper braid, nom. coverage 85%</i>
Guaina <i>Jacket</i>	Poliuretano antiolio, antifiamma, colore viola Desina RAL 4001 <i>Polyurethane, oil-resistant and flame-resistant, Desina RAL 4001 violet color</i>
Temperatura di esercizio <i>Temperature range</i>	-10°C, +80°C
Tensione nominale <i>Voltage rating</i>	300 V
Resistenza max. c.c. <i>Max DC resistance</i>	72,5 Ω/km
Resistenza max. c.c. di loop <i>Max DC loop resistance</i>	145,0 Ω/km
Impedenza caratteristica <i>Characteristic impedance</i>	150 Ω
Capacità <i>Capacitance</i>	29 nF/km @ 800 Hz
Resistenza dielettrica <i>Dielectric strength</i>	1500 V x 1 min (cond./cond. - cond./shield)
Raggio di curvatura <i>Bending radius</i>	10 volte diametro esterno del cavo <i>10 x cable outer diameter</i>
Velocità <i>Speed</i>	180 m/min
Accelerazione <i>Acceleration</i>	3 m/s ²
Riferimenti normativi costruttivi <i>Standards of construction</i>	Flame res.: IEC 60332-1, CSA FT1 Oil res.: IEC 60811-2-1, ASTM-oil-1 Other: VDE 0472 par. 1, VDE 0282/10, NEK 606, EN 50267-2-1, IEC 60754-1-2, UL 758, CSA AWM I/II A/B, cURus AWM Style 20233
Riferimenti normativi d'impiego <i>Standards of use</i>	ANSI/NFPA 79, UL 508a, CSA C22.1 (CE Code), CSA C22.2 No.286, Style 20233

Marcatura - Marking

TEKIMA 71140 "PROFIBUS" – CE (1x2x0,25) mm² 80°C 300 V IEC 60332-1 – c(UR)us E314444 AWM Style 20233 (1x2x24) AWG 80°C 300 V AWM Class III A/B FT1 – 150 Ohm – (prod.reference) = (metric) =

Codifiche e dimensioni - Coding and dimensions

Codice <i>Code</i>	N. conduttori x sezione <i>Num. conductors x Size [mm²]</i>	N. conduttori x sezione <i>Num. conductors x Size [AWG]</i>	Diametro <i>Diameter [mm]</i>	Peso <i>Weight [kg/km]</i>
CVFD0001_71140_D3	(1x2x0,25)	(1x2x24)	7,9	65

SERIES
71600

Cavi per trasmissione dati Profibus CMX ad alte prestazioni



High performances Profibus CMX data communication cables

“UL Listed”, posa mobile - Dynamic application



Impiego - Use

Cavo per BUS di campo a marchio UL Listed, prodotto in accordo alla norma UL 444 e adatto per posa mobile in catena portacavo anche di elevata lunghezza (movimentazioni continue su assi cartesiani) e per gli impieghi previsti dall'articolo 800 del ANSI/NFPA 70 "National Electrical Code" (NEC). La doppia schermatura (elettrostatica ed elettromagnetica) lo rende adatto in ambienti con problematiche di compatibilità elettromagnetica (EMC). La speciale guaina in poliuretano garantisce ottime prestazioni meccaniche, una ottima resistenza all'abrasione ed una ottima resistenza ai più utilizzati olii lubrificanti e fluidi industriali.

UL Listed field BUS cable produced according to UL 444 Standard and designed for mobile installation on a cable holder chain, even with great length (continuous motion on Cartesian axis) and for the uses specified by Art. 800 of ANSI/NFPA 70 "National Electrical Code" (NEC). The double shielding (electrostatic and electromagnetic) makes it suitable for environments with electromagnetic compatibility (EMC) problems. The special polyurethane jacket grants very good mechanical performance, a very good abrasion resistance and a very good resistance to the most common industrial oils and fluids.

Informazione. Si effettua, su richiesta, un servizio aggiuntivo di taglio a misura certificato UL ("Processed Wire").

Information. An additional UL certified cut-to-length service is carried out on request ("Processed Wire").

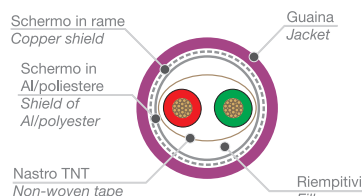

Dati tecnici - Technical data

Caratteristica - Characteristics	Valore/proprietà - Value/property
Conduttore <i>Conductor</i>	Rame ad elevata flessibilità 19X0,13 mm (0,25 mm ²) <i>Flexible copper strand 19X0,13 mm (0,25 mm²)</i>
Isolamento <i>Insulation</i>	TKblend®-L
Conduttori <i>Conductors</i>	Twistati, colorazione verde/rosso <i>Twisted, green/red colors</i>
Nastratura <i>Taping</i>	Nastro tessuto non tessuto <i>Non-woven tape</i>
Schermatura <i>Shield</i>	Nastro alluminio/poliestere e treccia di rame stagnato con ricopertura nom. 85% <i>Aluminum/polyester tape and tinned copper braid, nom. coverage 85%</i>
Guaina <i>Jacket</i>	Poliuretano antiolio, antifiamma e resistente ai raggi UV. Colore viola Desina RAL 4001 <i>Polyurethane, oil-, flame- and UV-resistant. Desina RAL 4001 violet color</i>
Temperatura di esercizio <i>Temperature range</i>	-30°C, +70°C (posa mobile); -40°C, +75°C (posa fissa) <i>-30°C, +70°C (dynamic); -40°C, +75°C (fixed)</i>
Tensione nominale <i>Voltage rating</i>	300 V
Resistenza max. conduttore c.c. <i>Max DC conductor resistance</i>	74 Ω/km
Impedenza caratteristica <i>Characteristic impedance</i>	150 Ω
Capacità <i>Capacitance</i>	30 nF/km @ 800 Hz
Resistenza dielettrica <i>Dielectric strength</i>	1500 V x 1 min (cond./cond. - cond./shield)
Raggio di curvatura <i>Bending radius</i>	6 volte diametro esterno del cavo (posa fissa) 12 volte diametro esterno del cavo (posa mobile) <i>6 x cable outer diameter (fixed)</i> <i>12 x cable outer diameter (dynamic)</i>
Velocità <i>Speed</i>	180 m/min
Accelerazione <i>Acceleration</i>	3 m/s ²
Riferimenti normativi costruttivi <i>Standards of construction</i>	Flame res.: IEC 60332-1-2, UL 1581 par. 1080 Oil res.: IEC 60811-2-1, ASTM-oil-1, ICEA S-82-552 UV res.: UL 1581 par. 1200 Other: VDE 0472 par. 1, VDE 0282/10, NEK 606, EN 50267-2-1, EN 50267-2-2, IEC 60754-1, IEC 60754-2, UL 444
Riferimenti normativi d'impiego <i>Standards of use</i>	UL 444 (type CMX), NFPA 70 (Art. 800)

Marcatura - Marking

TEKIMA 71640 "PROFIBUS" – CE (1x2x0,25) mm² IEC 60332-1 – c(UL)us E501447 CMX 75°C (1x2x24) AWG VW-1 150 Ohm – (prod.reference) = (metric) =

Codifiche e dimensioni - Coding and dimensions

Codice <i>Code</i>	N. conduttori x sezione <i>Num. conductors x Size [mm²]</i>	N. conduttori x sezione <i>Num. conductors x Size [AWG]</i>	Diametro <i>Diameter [mm]</i>	Peso <i>Weight [kg/km]</i>
CVFD0001_71640_D3	(1x2x0,25)	(1x2x24)	8,2	72

SERIES
73000

Cavi per trasmissione dati DeviceNet

DeviceNet data communication cables



Posa fissa - Fixed application



DeviceNet™



Impiego - Use

Il cavo per BUS di campo DeviceNet è stato progettato per il collegamento in posa fissa di apparecchiature industriali ed è composto da due coppie di conduttori, la prima per l'alimentazione realizzata con conduttori di colore rosso e nero, la seconda per il segnale realizzata con conduttori di colore blu e bianco. La gamma di cavi si differenzia in tipo Trunk utilizzato per linee dorsali della rete DeviceNet ed in tipo Drop che collega i dispositivi alla linea dorsale mediante derivazione. La guaina, in mescola speciale a base di PVC, garantisce ottime prestazioni meccaniche.

The DeviceNet field BUS cable has been planned for the fixed application connection of industrial equipment, and is made of two couples of connectors, the first for the power supply made with red and black conductors, the second for the signal made with blue and white conductors. The range of cables includes a Trunk type used for the main lines of DeviceNet network and Drop type, connecting the devices to the main line through derivation. The jacket, made of a special PVC compound, grants very good mechanical performance.

Informazione. Si effettua, su richiesta, un servizio aggiuntivo di taglio a misura certificato UL ("Processed Wire").

Information. An additional UL certified cut-to-length service is carried out on request ("Processed Wire").

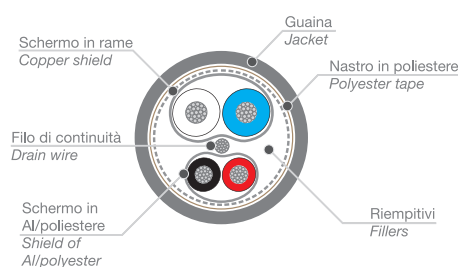

Dati tecnici - Technical data

Caratteristica - Characteristics	Valore/proprietà - Value/property
Conduttore <i>Conductor</i>	Rame stagnato. Tipo Drop: conduttore segnale 19x0,13 mm (0,25 mm ²), conduttore alimentazione 19x0,16 mm (0,35 mm ²) Tipo Trunk: conduttore segnale 19x0,25 mm (0,93 mm ²), conduttore alimentazione 19x0,36 mm (1,93 mm ²) <i>Tinned copper strand.</i> Drop type: signal conductor 19x0,13 mm (0,25 mm ²), power conductor 19x0,16 mm (0,35 mm ²) Trunk type: signal conductor 19x0,25 mm (0,93 mm ²), power conductor 19x0,36 mm (1,93 mm ²)
Isolamento <i>Insulation</i>	TKblend®-L
Conduttori <i>Conductors</i>	Twistati, colorazione rosso/nero (alimentazione), blu/bianco (segnale) <i>Twisted, black/red colors (power), blue/white (signal)</i>
Schermatura <i>Shield</i>	Sulle coppie in nastro alluminio/poliestere (con ricopertura 100%), sul totale in treccia di rame stagnato ricopertura nom. 65%. Filo di continuità 22/19 AWG. <i>Aluminum/polyester tape on pairs (coverage 100%), overall tinned copper braid, nom. coverage 65%. Drain wire 22/19 AWG.</i>
Guaina <i>Jacket</i>	Mescola PVC antifiama, antioilo. Colore grigio RAL 7001. <i>PVC compound, oil-resistant and flame-resistant RAL 7001 gray color.</i>
Temperatura di esercizio <i>Temperature range</i>	-40°C, +80°C
Tensione nominale <i>Voltage rating</i>	300 V
Impedenza caratteristica <i>Characteristic impedance</i>	120 Ω
Capacità <i>Capacitance</i>	40 nF/km @ 800 Hz
Resistenza dielettrica <i>Dielectric strength</i>	2000 V x 1 min (cond./cond. - cond./shield)
Raggio di curvatura <i>Bending radius</i>	10 volte diametro esterno del cavo <i>10 x cable outer diameter</i>
Riferimenti normativi costruttivi <i>Standards of construction</i>	Flame res.: IEC 60332-1, UL 1581, CSA FT2 I Oil res.: IEC 60811-2-1, ICEA S-82-552 I Other: UL 1581, UL 758, CSA AWM I/II A/B, cURus AWM Style 2571 or Style 20601
Riferimenti normativi d'impiego <i>Standards of use</i>	ANSI/NFPA 79, UL 508a, CSA C22.1 (CE Code), CSA C22.2 No.286, Style 2571 or Style 20601

Marcatura - Marking

TEKIMA 73010 "DEVICENET" - CE ((2x0,25)+(2x0,35)) mm² 80°C IEC 60332-1 - c(UR)us E314444 AWM Style 2571 ((2x24)+(2x22)) AWG 80°C 300 V AWM I/II A/B FT2 - 120 Ohm - (prod.reference) = (metric) =

Codifiche e dimensioni - Coding and dimensions

Codice <i>Code</i>	N. conduttori x sezione <i>Num. conductors x Size [mm²]</i>	N. conduttori x sezione <i>Num. conductors x Size [AWG]</i>	Tipologia <i>Type</i>	Diametro <i>Diameter [mm]</i>	Peso <i>Weight [kg/km]</i>	Resistenza max. c.c. <i>Max DC resistance [Ω/km]</i>
CVFD0001_73010_GR	[(2x0,25)+(2x0,35)]	[(2x24)+(2x22)]	Drop	6,9	71	78,0 (data), 54,0 (power)
CVFD0002_73010_GR	[(2x1)+(2x1,5)]	[(2x18)+(2x15)]	Trunk	12	220	23,2 (data), 11,3 (power)

SERIES
73100

Cavi per trasmissione dati DeviceNet

DeviceNet data communication cables

Posa mobile – Dynamic applications



DeviceNet™



Impiego - Use

Il cavo per BUS di campo DeviceNet posa mobile è stato progettato per il collegamento in posa mobile di apparecchiature industriali e viene normalmente installato in catene portacavo anche ad elevata lunghezza (movimentazioni continue su assi cartesiani). Il cavo è composto da due coppie di conduttori, la prima per l'alimentazione con conduttori di colore rosso e nero, la seconda per il segnale con conduttori di colore blu e bianco. La gamma di cavi si differenzia in cavo Trunk utilizzato per linee dorsali della rete DeviceNet ed in cavo Drop che collega i dispositivi alla linea dorsale mediante derivazione. La guaina in poliuretano garantisce ottime prestazioni meccaniche ed una ottima resistenza ai più utilizzati olii lubrificanti e fluidi industriali.

The DeviceNet field BUS cable for mobile installation has been planned for the mobile application connection of industrial equipment and is normally installed on cable holder chains, even with great length (continuous motion on Cartesian axis). The cable is made of two couples of conductors, the first one for power supply with red and black conductors, the second one for the signal with blue and white conductors. The range of cables includes the Trunk cable used for the main lines of the DeviceNet network, and the Drop cable connecting the devices to the main line through a derivation. The polyuretan jacket grants very good mechanical performances and a very good resistance to the most used industrial oils and fluids.

Informazione. Si effettua, su richiesta, un servizio aggiuntivo di taglio a misura certificato UL ("Processed Wire").

Information. An additional UL certified cut-to-length service is carried out on request ("Processed Wire").

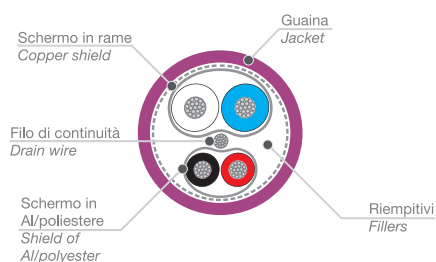

Dati tecnici - Technical data

Caratteristica - Characteristics	Valore/proprietà - Value/property
Conduttore <i>Conductor</i>	Rame stagnato. Tipo Drop: conduttore segnale 19x0,13 mm (0,25 mm ²), conduttore alimentazione 19x0,16 mm (0,35 mm ²) <i>Tinned copper strand.</i> Drop type: signal conductor 19x0,13 mm (0,25 mm ²), power conductor 19x0,16 mm (0,35 mm ²)
Isolamento <i>Insulation</i>	TKblend®-L
Conduttori <i>Conductors</i>	Twistati, colorazione rosso/nero (alimentazione), blu/bianco (segnale) <i>Twisted, black/red colors (power), blue/white (signal)</i>
Schermatura <i>Shield</i>	Sulle coppie in nastro alluminio/poliestere (con ricopertura 100%), sul totale in treccia di rame stagnato ricopertura nom. 65%. Filo di continuità 22/19 AWG. <i>Aluminum/polyester tape on pairs (coverage 100%), overall tinned copper braid, nom. coverage 65%. Drain wire 22/19 AWG.</i>
Guaina <i>Jacket</i>	Poliuretano antiolio, antifiamma, halogen free. Colore viola Desina RAL 4001 <i>Polyuretan, oil-resistant and flame-resistant and halogen, free. Desina RAL 4001 violet color</i>
Temperatura di esercizio <i>Temperature range</i>	-40°C, +80°C
Tensione nominale <i>Voltage rating</i>	300 V
Resistenza max. c.c. <i>Max DC resistance</i>	78,0 Ω/km (data), 54,0 Ω/km (power)
Impedenza caratteristica <i>Characteristic impedance</i>	120 Ω
Capacità <i>Capacitance</i>	40 nF/km @ 800 Hz
Resistenza dielettrica <i>Dielectric strength</i>	2000 V x 1 min (cond./cond. - cond./shield)
Raggio di curvatura <i>Bending radius</i>	10 volte diametro esterno del cavo <i>10 x cable outer diameter</i>
Velocità <i>Speed</i>	180 m/min
Accelerazione <i>Acceleration</i>	5 m/s ²
Riferimenti normativi costruttivi <i>Standards of construction</i>	Flame res.: IEC 60332-1, UL 1581, CSA FT2 Oil res.: IEC 60811-2-1, ICEA S-82-552, ASTM-oil-1 Other: EN 50267-2-1, IEC 60754-1-2, NEK 606, VDE 0472 par. 1, VDE 0282/10, UL 758, CSA AWM I/II A/B, cURus AWM Style 20978
Riferimenti normativi d'impiego <i>Standards of use</i>	ANSI/NFPA 79, UL 508a, CSA C22.1 (CE Code), CSA C22.2 No.286, Style 20978

Marcatura - Marking

TEKIMA 73130 "DEVICENET" – CE ((2x0,25)+(2x0,35)) mm² 80°C 300 V IEC 60332-1 – c(UR)us E31 4444 AWM Style 20978 ((2x24)+(2x22)) AWG 80°C 300 V AWM Class I/II A/B FT2 – 120 Ohm – (prod.reference) = (metric) =

Codifiche e dimensioni - Coding and dimensions

Codice <i>Code</i>	N. conduttori x sezione <i>Num. conductors x Size [mm²]</i>	N. conduttori x sezione <i>Num. conductors x Size [AWG]</i>	Tipologia <i>Type</i>	Diametro <i>Diameter [mm]</i>	Peso <i>Weight [kg/km]</i>
CVFD0001_73130_D3	[(2x0,25)+(2x0,35)]	[(2x24)+(2x22)]	Drop	6,9	68

SERIES
74100

Cavi per trasmissione dati CanOpen

CanOpen data communication cables



Posa fissa - Fixed application



Impiego - Use

Il cavo per BUS di campo CanOpen (Control Area Network), inizialmente studiato per il settore automobilistico, trova ora impiego anche nel settore industriale. Progettato per impieghi in posa fissa, il cavo è adatto per ambienti con problematiche di compatibilità elettromagnetica (EMC). La speciale guaina a base di PVC garantisce buone prestazioni meccaniche, una buona resistenza all'abrasione ed una ottima resistenza ai più utilizzati olii lubrificanti e fluidi industriali.

The CanOpen (Control Area Network) field BUS cable, at first planned for the automotive sector, is now employed also in the industrial one. This cable has been planned for fixed installation use, and is suitable for environments with electromagnetic compatibility (EMC) problems. The special PVC jacket grants good mechanical performances, a good abrasion resistance and a very good resistance to the most used industrial oils and lubricants.

Informazione. Si effettua, su richiesta, un servizio aggiuntivo di taglio a misura certificato UL ("Processed Wire").

Information. An additional UL certified cut-to-length service is carried out on request ("Processed Wire").

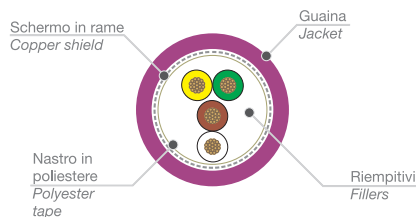

Dati tecnici - Technical data

Caratteristica - Characteristics	Valore/proprietà - Value/property
Conduttore <i>Conductor</i>	Per sezione 0,34 mm ² trefolo da 7x0,25 mm Per sezione 0,22 mm ² trefolo da 7x0,20 mm Size 0,34 mm ² strand 7x0,25 mm Size 0,22 mm ² strand 7x0,20 mm
Isolamento <i>Insulation</i>	TKblend®-L
Conduttori <i>Conductors</i>	Twistati, colorazione DIN 47100 (bianco, marrone, verde, giallo) Twisted, DIN 47100 colors (white, brown, green, yellow)
Nastratura <i>Taping</i>	Nastro di poliestere Polyester tape
Schermatura <i>Shield</i>	Treccia di rame stagnato con ricopertura nom. 85% Tinned copper braid, nom. coverage 85%
Guaina <i>Jacket</i>	Miscela di PVC antioio e antifiamma. Colore viola Desina RAL 4001 PVC compound, oil-resistant and flame-retardant. Desina RAL 4001 violet color
Temperatura di esercizio <i>Temperature range</i>	-20°C, +80°C
Tensione nominale <i>Voltage rating</i>	300 V
Impedenza caratteristica <i>Characteristic impedance</i>	120 Ω
Capacità <i>Capacitance</i>	40 pF/m
Resistenza dielettrica <i>Dielectric strength</i>	1500 V x 1 min (cond./cond.) 1000 V x 1 min (cond./shield)
Raggio di curvatura <i>Bending radius</i>	10 volte diametro esterno del cavo 10 x cable outer diameter
Riferimenti normativi costruttivi <i>Standards of construction</i>	Flame res.: IEC 60332-1, UL 1581, CSA FT2 I Other: UL 758, CSA AWM III A/B, cURus AWM Style 20601
Riferimenti normativi d'impiego <i>Standards of use</i>	ANSI/NFPA 79, UL 508a, CSA C22.1 (CE Code), CSA C22.2 No.286, Style 20601

Marcatura - Marking

TEKIMA 74100 "CanTek" – CE (1x2x0,34) mm² 80°C 300 V IEC 60332-1 – c(UR)us E314444 AWM Style 20601 (1x2x22) AWG 80°C 300 V AWM Class III A/B FT2 – 120 Ohm – (prod. reference) = (metric) =

Codifiche e dimensioni - Coding and dimensions

Codice <i>Code</i>	N. conduttori x sezione <i>Num. conductors x Size [mm²]</i>	N. conduttori x sezione <i>Num. conductors x Size [AWG]</i>	Diametro <i>Diameter [mm]</i>	Peso <i>Weight [kg/km]</i>
CVFD0001_74100_D3	[2x(2x0,22)]	[2x(2x24)]	7,5	69
CVFD0002_74100_D3	[2x(2x0,34)]	[2x(2x22)]	8,5	78
CVFD0003_74100_D3	[1x(2x0,34)]	[1x(2x22)]	6,5	48
CVFD0004_74100_D3	[3x(2x0,34)]	[3x(2x22)]	9,0	105

SERIES
74000

Cavi per trasmissione dati CanOpen

CanOpen data transmission cables

Posa mobile - Dynamic application



Impiego - Use

Il cavo per BUS di campo CanOpen (Control Area Network), inizialmente studiato per il settore automobilistico, trova ora impiego anche nel settore industriale. Progettato per impieghi in posa mobile su assi cartesiani, il cavo è adatto per ambienti con problematiche di compatibilità elettromagnetica (EMC). La speciale guaina in poliuretano garantisce ottime prestazioni meccaniche, una ottima resistenza all'abrasione ed una ottima resistenza ai più utilizzati olii lubrificanti e fluidi industriali.

The CanOpen (Control Area Network) field BUS cable, at first planned for the automotive sector, is now employed also in the industrial one. This cable has been planned for the use in mobile installations on Cartesian axis, and is suitable for environments with electromagnetic compatibility (EMC) problems. The special polyuretan jacket grants very good mechanical performances, a very good abrasion resistance and a good resistance to the most used industrial oils and fluids.

Informazione. Si effettua, su richiesta, un servizio aggiuntivo di taglio a misura certificato UL ("Processed Wire").

Information. An additional UL certified cut-to-length service is carried out on request ("Processed Wire").

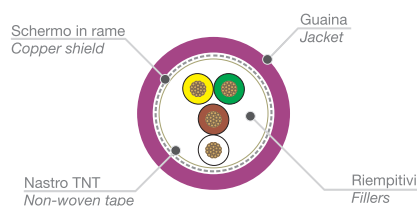

Dati tecnici - Technical data

Caratteristica - Characteristics	Valore/proprietà - Value/property
Conduttore <i>Conductor</i>	0,25 mm ² (32x0,10 mm)
Isolamento <i>Insulation</i>	TKblend®-L
Conduttori <i>Conductors</i>	Twistati, colorazione DIN 47100 (bianco, marrone, verde, giallo) <i>Twisted, DIN 47100 colors (white, brown, green, yellow)</i>
Nastratura <i>Taping</i>	Nastro di tessuto non-tessuto <i>Non-woven tape</i>
Schermatura <i>Shield</i>	Treccia di rame stagnato con ricopertura nom. 85% <i>Tinned copper braid, nom. coverage 85%</i>
Guaina <i>Jacket</i>	PUR halogen free. Colore viola Desina RAL 4001 <i>PUR halogen free. Desina RAL 4001 violet color.</i>
Temperatura di esercizio <i>Temperature range</i>	-40°C, +80°C
Tensione nominale <i>Voltage rating</i>	300 V
Resistenza max. c.c. <i>Max DC resistance</i>	79,0 Ω/km
Impedenza caratteristica <i>Characteristic impedance</i>	120 Ω
Resistenza dielettrica <i>Dielectric strength</i>	1500 V x 1 min (cond./cond.) 1000 V x 1 min (cond./shield)
Raggio di curvatura <i>Bending radius</i>	10 volte diametro esterno del cavo <i>10 x cable outer diameter</i>
Velocità <i>Speed</i>	180 m/min
Accelerazione <i>Acceleration</i>	5 m/s ²
Riferimenti normativi costruttivi <i>Standards of construction</i>	Flame res.: IEC 60332-1, UL 1581, CSA FT2 I Oil res.: IEC 60811-2-1, ICEA S-82-552, ASTM-oil-1 I Other: VDE 0472 par. 1, VDE 0282/10, NEK 606, UL 758, CSA AWM I/II A/B, cURus AWM Style 20978
Riferimenti normativi d'impiego <i>Standards of use</i>	ANSI/NFPA 79, UL 508a, CSA C22.1 (CE Code), CSA C22.2 No.286, Style 20978

Marcatura - Marking

TEKIMA 74000 "CanTek" – CE (1x2x0,25) mm² 80°C 300 V IEC 60332-1 – c(UR)us E314444 AWM Style 20978 (1x2x24) AWG 80°C 300 V AWM Class I/II A/B FT2 – 120 Ohm – (prod. reference) = (metric) =

Codifiche e dimensioni - Coding and dimensions

Codice <i>Code</i>	N. conduttori x sezione <i>Num. conductors x Size [mm²]</i>	N. conduttori x sezione <i>Num. conductors x Size [AWG]</i>	Diametro <i>Diameter [mm]</i>	Peso <i>Weight [kg/km]</i>
CVFD0001_74000_D3	[1x(2x0,25)]	[1x(2x24)]	6,2	49
CVFD0002_74000_D3	[2x(2x0,25)]	[2x(2x24)]	8,4	76

SERIES
75000

Cavi per trasmissione dati Ethernet industriale

Industrial Ethernet data transmission cables



Posa fissa - Fixed application

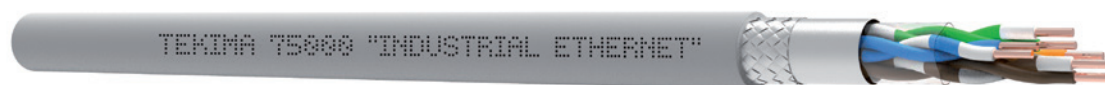

Impiego - Use

Le reti Ethernet ed il protocollo TCP/IP sono i sistemi di comunicazione dati attualmente tra i più diffusi nell'automazione industriale. Si tratta di tecnologie di comunicazione potenti che consentono l'integrazione con l'ambiente Office, funzionalità IT, Internet/Intranet, configurazione remota. Il cavo è progettato per impieghi in posa fissa, è adatto per ambienti con problematiche di compatibilità elettromagnetica (EMC). La speciale guaina a base di PVC garantisce buone prestazioni meccaniche, una buona resistenza all'abrasione ed una ottima resistenza ai più utilizzati olii lubrificanti e fluidi industriali.

The Ethernet networks and the TCP/IP protocol are among the most widespread data communication systems of the industrial automation. These are powerful communication technologies which permit integration with the Office environment, IT functionality, Internet/Intranet, remote configuration. The cable is planned for fixed application and is suitable for environments with electromagnetic compatibility (EMC) problems. The special PVC jacket grants good mechanical performances, a good abrasion resistance and a very good resistance to the most used industrial oils and fluids.

Informazione. Si effettua, su richiesta, un servizio aggiuntivo di taglio a misura certificato UL ("Processed Wire").

Information. An additional UL certified cut-to-length service is carried out on request ("Processed Wire").

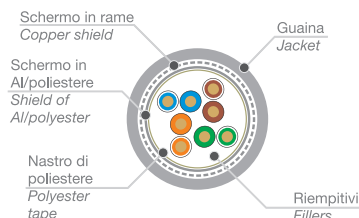

Dati tecnici - Technical data

Caratteristica - Characteristics	Valore/proprietà - Value/property
Categoria	Ethernet SF/UTP Cat.5e <i>Ethernet SF/UTP Cat.5e</i>
Conduttore <i>Conductor</i>	Rigido in rame rosso da 0,22 mm ² <i>Rigid bare copper 0,22 mm²</i>
Isolamento <i>Insulation</i>	TKblend®-L
Conduttori <i>Conductors</i>	Twistati, colorati ad anello o a strisce. Cavo 4 coppie (Bianco/Blu+Blu); (Bianco/Arancione+Arancione); (Bianco/Verde+Verde);(Bianco/Marrone+Marrone) Cavo 2 coppie (Bianco/Arancione+Arancione); (Bianco/Verde+Verde) <i>Twisted, colored in rings or stripes.</i> <i>4 pairs cable (White/Blue+Blue);</i> <i>(White/Orange+Orange);(White/Green+Green), (White/</i> <i>Brown+Brown)</i> <i>2 pairs cable (White/Orange+Orange),</i> <i>(White/Green+Green)</i>
Nastratura <i>Taping</i>	Nastro di poliestere <i>Polyester tape</i>
Schermatura <i>Shield</i>	Nastro in alluminio/poliestere e treccia di rame stagna- to con ricopertura nom. 85% <i>Aluminum/polyester tape and tinned copper braid,</i> <i>nom. coverage 85%</i>
Guaina <i>Jacket</i>	Mescola di PVC antiolio, antifiamma e resistente ai raggi UV. Colore grigio. <i>PVC compound, oil-resistant, flame retardant and UV</i> <i>resistant. Gray color.</i>
Temperatura di esercizio <i>Temperature range</i>	-30°C, +80°C
Tensione nominale <i>Voltage rating</i>	300 V
Resistenza max. c.c. <i>Max DC resistance</i>	93,8 Ω/km
Impedenza caratteristica <i>Characteristic impedance</i>	100 Ω
Capacità <i>Capacitance</i>	48 pF/m
Resistenza dielettrica <i>Dielectric strength</i>	1000 V x 1 min (cond./cond.) 700 V x 1 min (cond./shield)
Raggio di curvatura <i>Bending radius</i>	10 volte diametro esterno del cavo <i>10 x cable outer diameter</i>
Riferimenti normativi costruttivi <i>Standards of construction</i>	Flame res.: IEC 60332-1-2, UL 1581, CSA FT2 I Oil res.: IEC 60811-2-1 UV res.: UL 1581 par.1200 I Other: UL 1581, UL 758, EN 61156-5, EN 50288-2-1, CSA AWM I/II A/B, cURus AWM Style 20601
Riferimenti normativi d'impiego <i>Standards of use</i>	ANSI/NFPA 79, UL 508a, CSA C22.1 (CE Code), CSA C22.2 No.286, Style 20601

Marcatura - Marking

TEKIMA 75020 "Industrial Ethernet" SF/UTP CAT.5e – CE (2x(2x0,21) mm² 80°C 300 V IEC 60332-1 – c(UR)us E314444 AWM Style 20601 (2x2x24) AWM 80°C AWM Class I/II A/B 80°C 300 V FT2 – (prod.reference) = (metric) =

Codifiche e dimensioni - Coding and dimensions

Codice <i>Code</i>	N. conduttori x sezione <i>Num. conductors x Size [mm²]</i>	N. conduttori x sezione <i>Num. conductors x Size [AWG]</i>	Diametro <i>Diameter [mm]</i>	Peso <i>Weight [kg/km]</i>
CVFD0001_75020_GR	[2x(2x0,21)]	[2x(2x24)]	6,0	44
CVFD0002_75020_GR	[4x(2x0,21)]	[4x(2x24)]	6,4	58

SERIES
75500

Cavi per trasmissione dati Ethernet industriale CMR

Industrial Ethernet CMR data transmission cables

“UL Listed”, posa fissa - Fixed application



Impiego - Use

Cavo per reti Ethernet a marchio UL Listed prodotto in accordo alla norma UL 444. Le reti Ethernet ed il protocollo TCP/IP sono i sistemi di comunicazione dati attualmente tra i più diffusi nell'automazione industriale. Si tratta di tecnologie di comunicazione potenti che consentono l'integrazione con l'ambiente Office, funzionalità IT, Internet/ Intranet, configurazione remota. Il cavo è progettato per impieghi in posa fissa, è adatto per ambienti con problematiche di compatibilità elettromagnetica (EMC). La speciale guaina a base di PVC garantisce buone prestazioni meccaniche, una buona resistenza all'abrasione ed una ottima resistenza ai più utilizzati olii lubrificanti e fluidi industriali.

UL Listed Ethernet cable produced according to UL 444. The Ethernet networks and the TCP/IP protocol are among the most widespread data communication systems of the industrial automation. These are powerful communication technologies which permit integration with the Office environment, IT functionality, Internet/ Intranet, remote configuration. The cable is planned for fixed application and is suitable for environments with electromagnetic compatibility (EMC) problems. The special PVC jacket grants good mechanical performances, a good abrasion resistance and a very good resistance to the most used industrial oils and fluids.

Informazione. Si effettua, su richiesta, un servizio aggiuntivo di taglio a misura certificato UL ("Processed Wire").

Information. An additional UL certified cut-to-length service is carried out on request ("Processed Wire").

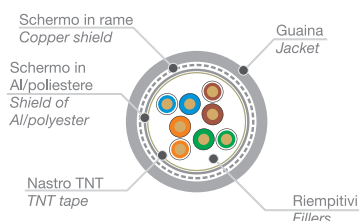

Marcatura - Marking

TEKIMA 75530 "Industrial Ethernet" S/FTP CAT.5e - CE (2x2x0,21) mm² 60°C 125 V IEC 60332-1 - c(UL)us CMR E501447 (2x2x24) AWG 60°C 125 V - (prod.reference) = (metric) =

Dati tecnici - Technical data

Caratteristica - Characteristics	Valore/proprietà - Value/property
Categoria	Ethernet S/FTP o SF/UTP Cat.5e <i>Ethernet S/FTP o SF/UTP Cat.5e</i>
Conduttore <i>Conductor</i>	Rigido in rame rosso da 0,22 mm ² <i>Rigid bare copper 0,22 mm²</i>
Isolamento <i>Insulation</i>	TKblend®-L
Conduttori <i>Conductors</i>	Twistati, colorati ad anello o a strisce. Cavo 4 coppie (Bianco/Blu+Blu); (Bianco/Arancione+Arancione); (Bianco/Verde+Verde);(Bianco/Marrone+Marrone) Cavo 2 coppie (Bianco/Arancione+Arancione); (Bianco/Verde+Verde) <i>Twisted, colored in rings or stripes.</i> 4 pairs cable (White/Blue+Blue); (White/Orange+Orange);(White/Green+Green), (White/Brown+Brown) 2 pairs cable (White/Orange+Orange), (White/Green+Green)
Nastratura <i>Taping</i>	Nastro di tessuto non-tessuto <i>Non-woven tape</i>
Schermatura <i>Shield</i>	Nastro in alluminio/poliestere e treccia di rame stagnato con ricopertura nom. 85% <i>Aluminum/polyester tape and tinned copper braid, nom. coverage 85%</i>
Guaina <i>Jacket</i>	Mescola di PVC antioili, antifiama e resistente ai raggi UV. Colore grigio. <i>PVC compound, oil-resistant, flame retardant and UV resistant. Gray color.</i>
Temperatura di esercizio <i>Temperature range</i>	-30°C, +75°C
Tensione nominale <i>Voltage rating</i>	125 V
Resistenza max. c.c. <i>Max DC resistance</i>	86,0 Ω/km
Impedenza caratteristica <i>Characteristic impedance</i>	100 Ω
Capacità <i>Capacitance</i>	48 pF/m
Resistenza dielettrica <i>Dielectric strength</i>	1000 V x 1 min (cond./cond.), 700 V x 1 min (cond./shield)
Raggio di curvatura <i>Bending radius</i>	8 volte diametro esterno del cavo <i>8 x cable outer diameter</i>
Riferimenti normativi costruttivi <i>Standards of construction</i>	Flame res.: IEC 60332-1, UL 1666 Oil res.: IEC 60811-2-1, EN 50363-4-1, DIN VDE 0472-803, ICEA S-82-552, NEMA WC55 UV res.: UL 1581 par. 1200 Other: UL 1581, EN 61156-5, EN 50288-1, ISO/IEC 11801
Riferimenti normativi d'impiego <i>Standards of use</i>	UL 444 (type CMR), NFPA 70 (Art. 800)

Codifiche e dimensioni - Coding and dimensions

Codice <i>Code</i>	N. conduttori x sezione <i>Num. conductors x Size [mm²]</i>	N. conduttori x sezione <i>Num. conductors x Size [AWG]</i>	Diametro <i>Diameter [mm]</i>	Peso <i>Weight [kg/km]</i>
CVFD0001_75530_GR	[2x(2x0,22)]	[2x(2x24)]	6,6	57
CVFD0002_75530_GR	(4x2x0,22)	(4x2x24)	6,8	67

**SERIES
75100**

Cavi per trasmissione dati Ethernet industriale

Industrial Ethernet data transmission cables



Posa mobile - Dynamic application



Impiego - Use

Le reti Ethernet ed il protocollo TCP/IP sono i sistemi di comunicazione dati attualmente tra i più diffusi nell'automazione industriale. Si tratta di tecnologie di comunicazione potenti che consentono l'integrazione con l'ambiente Office, funzionalità IT, Internet/Intranet, configurazione remota. Il cavo è progettato per impieghi in posa mobile, è adatto per ambienti con problematiche di compatibilità elettromagnetica (EMC). La speciale guaina a base di PUR garantisce buone prestazioni meccaniche, una buona resistenza all'abrasione ed una ottima resistenza ai più utilizzati olii lubrificanti e fluidi industriali.

The Ethernet networks and the TCP/IP protocol are among the most widespread data communication systems of the industrial automation. These are powerful communication technologies which permit integration with the Office environment, IT functionality, Internet/Intranet, remote configuration. The cable has been planned for dynamic application and is suitable for environments with electromagnetic compatibility (EMC) problems. The special PUR jacket grants good mechanical performances, a good abrasion resistance and a very good resistance to the most used industrial oils and fluids.

Informazione. Si effettua, su richiesta, un servizio aggiuntivo di taglio a misura certificato UL ("Processed Wire").

Information. An additional UL certified cut-to-length service is carried out on request ("Processed Wire").

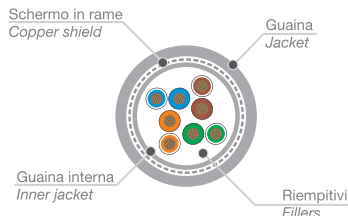

Dati tecnici - Technical data

Caratteristica - Characteristics	Valore/proprietà - Value/property
Categoria <i>Category</i>	Ethernet S/FTP Cat.5e <i>Ethernet S/FTP Cat.5e</i>
Conduttore <i>Conductor</i>	0,15 mm ² (19x0,10 mm)
Isolamento <i>Insulation</i>	TKblend®-L
Conduttori <i>Conductors</i>	Twistati, colorati ad anello o a strisce. Cavo 4 coppie (Bianco/Blu+Blu), (Bianco/Arancione+Arancione), (Bianco/Verde+Verde), (Bianco/Marrone+Marrone) <i>Twisted, colored in rings or stripes.</i> <i>4 pairs cable (White/Blue+ Blue),</i> <i>(White/Orange+Orange), (White/Green+Green),</i> <i>(White/Brown+Brown)</i>
Guaina interna <i>Internal jacket</i>	TPE halogen free <i>TPE halogen free</i>
Schermatura <i>Shield</i>	Treccia di rame stagnato con ricopertura nom. 85% <i>Tinned copper braid, nom. coverage 85%</i>
Guaina <i>Jacket</i>	Poliuretano halogen free. Colore grigio. <i>Polyurethane halogen free. Gray color.</i>
Temperatura di esercizio <i>Temperature range</i>	-40°C, +80°C
Tensione nominale <i>Voltage rating</i>	125 V
Resistenza max. c.c. in loop <i>Max DC loop resistance</i>	284,0 Ω/km
Impedenza caratteristica <i>Characteristic impedance</i>	100 Ω
Capacità <i>Capacitance</i>	48 pF/m
Resistenza dielettrica <i>Dielectric strength</i>	700 V x 1 min (cond./cond. - cond./shield)
Raggio di curvatura <i>Bending radius</i>	10 volte diametro esterno del cavo <i>10 x cable outer diameter</i>
Velocità <i>Speed</i>	180 m/min
Accelerazione <i>Acceleration</i>	3 m/s ²
Riferimenti normativi costruttivi <i>Standards of construction</i>	Oil res.: IEC 60811-2-1, ICEA S-82-552, ASTM-oil-1 Other: VDE 0472 par. 1, VDE 0282/10, NEK 606

Marcatura - Marking

TEKIMA 75120 "Industrial Ethernet" S/FTP CAT.5e – CE (4x2x0,15) mm² – (4x(2x26) AWG 80°C 125 V – (prod.reference) = (metric) =

Codifiche e dimensioni - Coding and dimensions

Codice <i>Code</i>	N. conduttori x sezione <i>Num. conductors x Size [mm²]</i>	N. conduttori x sezione <i>Num. conductors x Size [AWG]</i>	Diametro <i>Diameter [mm]</i>	Peso <i>Weight [kg/km]</i>
CVFD0001_75120_GR	[4x(2x0,15)]	[4x(2x26)]	6,3	56

SERIES
75200

Cavi per trasmissione dati Ethernet industriale Cat.6



Industrial Ethernet data transmission cables Cat.6

Posa mobile - Dynamic application



Impiego - Use

Le reti Ethernet ed il protocollo TCP/IP sono i sistemi di comunicazione dati attualmente tra i più diffusi nell'automazione industriale. Si tratta di tecnologie di comunicazione potenti che consentono l'integrazione con l'ambiente Office, funzionalità IT, Internet/Intranet, configurazione remota. Il cavo è progettato per impieghi in posa mobile, è adatto per ambienti con problematiche di compatibilità elettromagnetica (EMC). La speciale guaina a base di poliuretano termoplastico (TPU) garantisce buone prestazioni meccaniche, una buona resistenza all'abrasione ed una ottima resistenza ai più utilizzati olii lubrificanti e fluidi industriali.

The Ethernet networks and the TCP/IP protocol are among the most widespread data communication systems of the industrial automation. These are powerful communication technologies which permit integration with the Office environment, IT functionality, Internet/Intranet, remote configuration. The cable has been planned for dynamic application and is suitable for environments with electromagnetic compatibility (EMC) problems. The special thermoplastic polyurethane (TPU) jacket grants good mechanical performances, a good abrasion resistance and a very good resistance to the most used industrial oils and fluids.

Informazione. Si effettua, su richiesta, un servizio aggiuntivo di taglio a misura certificato UL ("Processed Wire").

Information. An additional UL certified cut-to-length service is carried out on request ("Processed Wire").

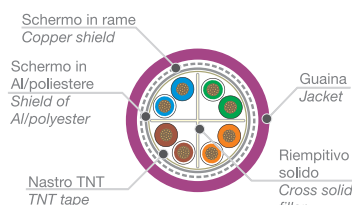

Dati tecnici - Technical data

Caratteristica - Characteristics	Valore/proprietà - Value/property
Categoria <i>Category</i>	Ethernet SF/UTP Cat.6 <i>Ethernet SF/UTP Cat.6</i>
Conduttore <i>Conductor</i>	0,15 mm ²
Isolamento <i>Insulation</i>	TKblend®-L
Conduttori <i>Conductors</i>	Twistati, colorati ad anello o a strisce. Cavo 4 coppie (Bianco/Blu+Blu), (Bianco/Arancione+Arancione), (Bianco/Verde+Verde), (Bianco/Marrone+Marrone) <i>Twisted, colored in rings or stripes.</i> <i>4 pairs cable (White/Blue+ Blue),</i> <i>(White/Orange+Orange), (White/Green+Green), (White/</i> <i>Brown+Brown)</i>
Nastratura <i>Taping</i>	Nastro di tessuto non-tessuto <i>Non-woven tape</i>
Schermatura <i>Shield</i>	Nastro in alluminio/poliestere e treccia di rame stagnato con ricopertura nom. 85% <i>Aluminum/polyester tape and tinned copper braid, nom. coverage 85%</i>
Guaina <i>Jacket</i>	Poliuretano halogen free e resistenze ai raggi UV. Colore viola. <i>Polyurethane halogen free and UV-resistant. Violet color.</i>
Temperatura di esercizio <i>Temperature range</i>	-30°C, +80°C (posa mobile); -40°C, +80°C (posa fissa) <i>-30°C, +80°C (dynamic); -40°C, +80°C (fixed)</i>
Tensione nominale <i>Voltage rating</i>	1000 V (work 50 V)
Resistenza max. c.c. in loop <i>Max DC loop resistance</i>	290,0 Ω/km
Impedenza caratteristica <i>Characteristic impedance</i>	100 Ω
Capacità <i>Capacitance</i>	47 pF/m
Resistenza dielettrica <i>Dielectric strength</i>	1000 Vac x 1 min
Raggio di curvatura <i>Bending radius</i>	6 volte diametro esterno del cavo (posa fissa) 8 volte diametro esterno del cavo (posa mobile) <i>6 x cable outer diameter (fixed)</i> <i>8 x cable outer diameter (dynamic)</i>
Velocità <i>Speed</i>	300 m/min
Accelerazione <i>Acceleration</i>	5 m/s ²
Riferimenti normativi costruttivi <i>Standards of construction</i>	Flame res.: IEC 60332-1-2, UL 1581 par. 1100 (FT2), 1090 I Oil res.: IEC 60811-2-1, ICEA S-82-552, ASTM Oil 1 UV res.: UL 1581 par. 1200 Other: VDE 0472 par.1, NEK 606, VDE 0282/10, EN 50267-2-1, IEC 60754-1, EN 50267-2-2, IEC 60754-2, IEC 61156-6, EN 50288-5-2, EN 50173-1, ISO/IEC 11801, UL 758, cURus AWM Style 21576
Riferimenti normativi d'impiego <i>Standards of use</i>	ANSI/NFPA 79, UL 508a, CSA C22.1 (CE Code), CSA C22.2 No.286, Style 21576

Marcatura - Marking

TEKIMA 75220 "Industrial Ethernet" SF/UTP CAT.6 – CE (4x2x0,15) mm² 80°C
IEC 60332-1-2 – c(UR)us E314444 AWM Style 21576 (4x2x26) AWG 80°C
1000 V AWM Class III A/B FT2 – (prod.reference) = (metric) =

Codifiche e dimensioni - Coding and dimensions

Codice <i>Code</i>	N. conduttori x sezione <i>Num. conductors x Size [mm²]</i>	N. conduttori x sezione <i>Num. conductors x Size [AWG]</i>	Diametro <i>Diameter [mm]</i>	Peso <i>Weight [kg/km]</i>
CVFD0001_75220_D3	[4x(2x0,15)]	[4x(2x26)]	7,2	64

**SERIES
75600**

Cavi per trasmissione dati Ethernet industriale CMX



Industrial Ethernet CMX data transmission cables

“UL Listed”, posa mobile - Dynamic application

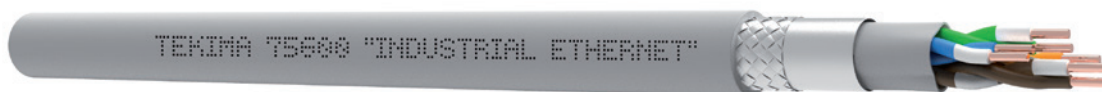

Impiego - Use

Cavo per reti Ethernet a marchio UL Listed prodotto in accordo alla norma UL 444. Le reti Ethernet ed il protocollo TCP/IP sono i sistemi di comunicazione dati attualmente tra i più diffusi nell'automazione industriale. Si tratta di tecnologie di comunicazione potenti che consentono l'integrazione con l'ambiente Office, funzionalità IT, Internet/ Intranet, configurazione remota. Il cavo è progettato per impieghi in posa mobile ed è adatto per ambienti con problematiche di compatibilità elettromagnetica (EMC). La speciale guaina a base di PUR garantisce buone prestazioni meccaniche, una buona resistenza all'abrasione ed una ottima resistenza ai più utilizzati olii lubrificanti e fluidi industriali.

UL Listed Ethernet cable produced according to UL 444. The Ethernet networks and the TCP/IP protocol are among the most widespread data communication systems of the industrial automation. These are powerful communication technologies which permit integration with the Office environment, IT functionality, Internet/Intranet, remote configuration. The cable has been planned for dynamic application and is suitable for environments with electromagnetic compatibility (EMC) problems. The special PUR jacket grants good mechanical performances, a good abrasion resistance and a very good resistance to the most used industrial oils and fluids.

Informazione. Si effettua, su richiesta, un servizio aggiuntivo di taglio a misura certificato UL ("Processed Wire").

Information. An additional UL certified cut-to-length service is carried out on request ("Processed Wire").

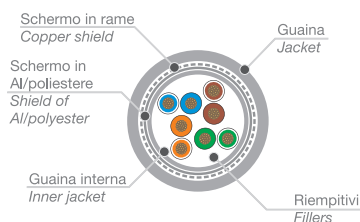

Dati tecnici - Technical data

Caratteristica - Characteristics	Valore/proprietà - Value/property
Categoria <i>Category</i>	Ethernet S/FTP Cat.5e <i>Ethernet S/FTP Cat.5e</i>
Conduttore <i>Conductor</i>	0,15 mm ² (19x0,10 mm)
Isolamento <i>Insulation</i>	TKblend®-L
Conduttori <i>Conductors</i>	Twistati, colorati ad anello o a strisce. Cavo 4 coppie (Bianco/Blu+Blu), (Bianco/Arancione+Arancione), (Bianco/Verde+Verde), (Bianco/Marrone+Marrone) <i>Twisted, colored in rings or stripes.</i> <i>4 pairs cable (White/Blue+ Blue),</i> <i>(White/Orange+Orange), (White/Green+Green), (White/</i> <i>Brown+Brown)</i>
Guaina interna <i>Internal jacket</i>	TPE halogen free <i>TPE halogen free</i>
Schermatura <i>Shield</i>	Nastro di alluminio/poliestere e treccia di rame stagnato con ricopertura nom. 85% <i>Aluminum/polyester tape and tinned copper braid, nom. coverage 85%</i>
Guaina <i>Jacket</i>	Poliuretano antifiama, halogen free e resistente ai raggi UV. Colore grigio. <i>Flame retardant, halogen free polyurethane and UV-resistant. Gray color.</i>
Temperatura di esercizio <i>Temperature range</i>	-30°C, +70°C (posa mobile); -40°C, +75°C (posa fissa) <i>-30°C, +70°C (dynamic); -40°C, +75°C (fixed)</i>
Tensione nominale <i>Voltage rating</i>	125 V
Resistenza max. conduttore c.c. <i>Max DC conductor resistance</i>	142,0 Ω/km
Impedenza caratteristica <i>Characteristic impedance</i>	100 Ω
Capacità <i>Capacitance</i>	48 pF/m
Resistenza dielettrica <i>Dielectric strength</i>	1000 V x 1 min (cond./cond.), 700 V x 1 min (cond./shield)
Raggio di curvatura <i>Bending radius</i>	10 volte diametro esterno del cavo (posa fissa) 15 volte diametro esterno del cavo (posa mobile) <i>10 x cable outer diameter (fixed)</i> <i>15 x cable outer diameter (dynamic)</i>
Velocità <i>Speed</i>	180 m/min
Accelerazione <i>Acceleration</i>	3 m/s ²
Riferimenti normativi costruttivi <i>Standards of construction</i>	Flame res.: IEC 60332-1-2, UL 1581 par. 1080 Oil res.: IEC 60811-2-1, ASTM-oil-1, ICEA S-82-552 UV res.: UL 1581 par. 1200 Other: VDE 0472 par. 1, VDE 0282/10, NEK 606, EN 50267-2-1, EN 50267-2-2, IEC 60754-1, IEC 60754-2, UL 444
Riferimenti normativi d'impiego <i>Standards of use</i>	UL 444 (type CMX), NFPA 70 (Art. 800)

Marcatura - Marking

TEKIMA 75620 "Industrial Ethernet" S/FTP CAT.5e – CE (4x2x0,15) mm² 75°C 125 V IEC 60332-1 – c(UL)us CMX E501447 (4x2x26) AWG 75°C 125 V – (prod.reference) = (metric) =

Codifiche e dimensioni - Coding and dimensions

Codice <i>Code</i>	N. conduttori x sezione <i>Num. conductors x Size [mm²]</i>	N. conduttori x sezione <i>Num. conductors x Size [AWG]</i>	Diametro <i>Diameter [mm]</i>	Peso <i>Weight [kg/km]</i>
CVFD0001_75620_GR	(4x2x0,15)	(4x2x26)	7,4	76

SERIES
75700

Cavi per trasmissione dati Ethernet industriale CMX Cat.6



Industrial Ethernet CMX data transmission cables Cat.6

“UL Listed”, posa mobile - Dynamic application



Impiego - Use

Cavo per reti Ethernet a marchio UL Listed prodotto in accordo alla norma UL 444. Le reti Ethernet ed il protocollo TCP/IP sono i sistemi di comunicazione dati attualmente tra i più diffusi nell'automazione industriale. Si tratta di tecnologie di comunicazione potenti che consentono l'integrazione con l'ambiente Office, funzionalità IT, Internet/ Intranet, configurazione remota. Il cavo è progettato per impieghi in posa mobile ed è adatto per ambienti con problematiche di compatibilità elettromagnetica (EMC). La speciale guaina a base di PUR garantisce buone prestazioni meccaniche, una buona resistenza all'abrasione ed una ottima resistenza ai più utilizzati olii lubrificanti e fluidi industriali.

UL Listed Ethernet cable produced according to UL 444. The Ethernet networks and the TCP/IP protocol are among the most widespread data communication systems of the industrial automation. These are powerful communication technologies which permit integration with the Office environment, IT functionality, Internet/Intranet, remote configuration. The cable has been planned for dynamic application and is suitable for environments with electromagnetic compatibility (EMC) problems. The special PUR jacket grants good mechanical performances, a good abrasion resistance and a very good resistance to the most used industrial oils and fluids.

Informazione. Si effettua, su richiesta, un servizio aggiuntivo di taglio a misura certificato UL (“Processed Wire”).

Information. An additional UL certified cut-to-length service is carried out on request (“Processed Wire”).

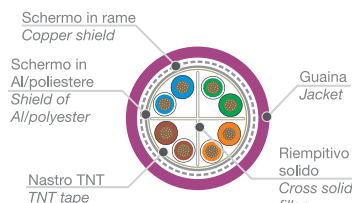

Dati tecnici - Technical data

Caratteristica - Characteristics	Valore/proprietà - Value/property
Categoria <i>Category</i>	Ethernet SF/UTP Cat.6 <i>Ethernet SF/UTP Cat.6</i>
Conduttore <i>Conductor</i>	0,15 mm ²
Isolamento <i>Insulation</i>	TKblend®-L
Conduttori <i>Conductors</i>	Twistati, colorati ad anello o a strisce. Cavo 4 coppie (Bianco/Blu+Blu), (Bianco/Arancione+Arancione), (Bianco/Verde+Verde), (Bianco/Marrone+Marrone) <i>Twisted, colored in rings or stripes.</i> 4 pairs cable (White/Blue+ Blue), (White/Orange+Orange), (White/Green+Green), (White/Brown+Brown)
Nastratura <i>Taping</i>	Nastro di tessuto non-tessuto <i>Non-woven tape</i>
Schermatura <i>Shield</i>	Nastro in alluminio/poliestere e treccia di rame stagnato con ricopertura nom. 85% <i>Aluminum/polyester tape and tinned copper braid, nom. coverage 85%</i>
Guaina <i>Jacket</i>	Poliuretano halogen free e resistenze ai raggi UV. Colore viola. <i>Polyurethane halogen free and UV-resistant. Violet color.</i>
Temperatura di esercizio <i>Temperature range</i>	+80°C (AWM/IEC), +75°C (CMX) -20°C (posa mobile/dynamic); -40°C (posa fissa/fixed)
Tensione nominale <i>Voltage rating</i>	300 V (work 50 V)
Resistenza max. c.c. in loop <i>Max DC loop resistance</i>	290,0 Ω/km
Impedenza caratteristica <i>Characteristic impedance</i>	100 Ω
Capacità <i>Capacitance</i>	47 pF/m
Resistenza dielettrica <i>Dielectric strength</i>	1000 Vac x 1 min
Raggio di curvatura <i>Bending radius</i>	6 volte diametro esterno del cavo (posa fissa) 8 volte diametro esterno del cavo (posa mobile) <i>6 x cable outer diameter (fixed)</i> <i>8 x cable outer diameter (dynamic)</i>
Velocità <i>Speed</i>	300 m/min
Accelerazione <i>Acceleration</i>	5 m/s ²
Riferimenti normativi costruttivi <i>Standards of construction</i>	Flame res.: IEC 60332-1-2, UL 1581 par. 1100 (FT2), 1090 I Oil res.: IEC 60811-2-1, ICEA S-82-552, ASTM IRM 901 IRM 902 I UV res.: UL 1581 par. 1200 I Other: VDE 0472 par.1, NEK 606, VDE 0282/10, EN 50267-2-1, IEC 60754-1, IEC 60754-1, IEC 61156-6, EN 50288-5-2, EN 50173-1, ISO/IEC 11801, UL 444, UL 758, cURus AWM Style 20549
Riferimenti normativi d'impiego <i>Standards of use</i>	UL 444 (type CMX), NFPA 70 (Art. 800), ANSI/NFPA 79, UL 508a, CSA C22.1 (CE Code), CSA C22.2 No.286, Style 20549

Marcatura - Marking

TEKIMA 75720 "Industrial Ethernet" SF/UTP CAT.6 – CE (4x2x0,15) mm² 80°C IEC 60332-1-2 – c(UL)us CMX E501447 (4x2x26) AWG 75°C VW-1 or AWM Style 20549 80°C 300V AWM Class I/II A/B FT2 – (prod.reference) = (metric) =

Codifiche e dimensioni - Coding and dimensions

Codice <i>Code</i>	N. conduttori x sezione <i>Num. conductors x Size [mm²]</i>	N. conduttori x sezione <i>Num. conductors x Size [AWG]</i>	Diametro <i>Diameter [mm]</i>	Peso <i>Weight [kg/km]</i>
CVFD0001_75720_D3	[4x(2x0,15)]	[4x(2x26)]	7,2	64

**SERIES
77000**

Cavi per trasmissione dati Profinet

Profinet data transmission cables



Posa fissa - Fixed application

UL US

PROFINET

RoHS

CE UK CA



Impiego - Use

Profinet è lo standard industriale Ethernet del consorzio Profibus e Profinet, tale sistema utilizza il protocollo TCP/IP consentendo una comunicazione in tempo reale con dispositivi industriali sempre più avanzati. Il cavo è progettato per impieghi in posa fissa con buona resistenza alle sollecitazioni meccaniche, alle basse temperature ed ai più utilizzati olii lubrificanti e fluidi industriali.

Profinet is the Ethernet industrial standard of Profibus and Profinet association. This system employs the TCP/IP protocol permitting a real-time communication with advanced industrial devices. The cable has been planned for fixed application, it exhibits a good resistance to the mechanical stress, to the low temperatures and to the most used industrial oils and fluids.

Informazione. Si effettua, su richiesta, un servizio aggiuntivo di taglio a misura certificato UL ("Processed Wire").
Information. An additional UL certified cut-to-length service is carried out on request ("Processed Wire").

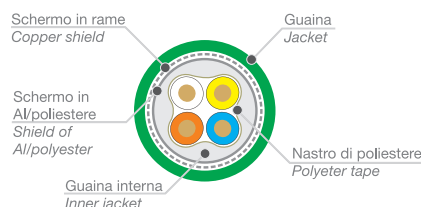

Dati tecnici - Technical data

Caratteristica - Characteristics	Valore/proprietà - Value/property
Categoria Category	Profinet S/FTP Cat.5e Profinet S/FTP Cat.5e
Conduttore Conductor	Rigido in rame rosso 1x0,64 mm Rigid bare copper 1x0,64 mm
Isolamento Insulation	TKblend®-L
Conduttori Conductors	Twistati (bianco, blu, giallo, arancione) Twisted (White, Blue, Yellow, Orange)
Nastratura Taping	Nastro di poliester Polyester tape
Guaina interna Internal jacket	Mescola di PVC PVC compound
Schermatura Shield	Nastro in alluminio/poliester e treccia di rame stagna- to con ricopertura nom. 85% Aluminum/polyester tape and tinned copper braid, nom. coverage 85%
Guaina Jacket	Mescola di PVC antiolio, antifiama e resistente ai raggi UV. Colore verde RAL 6018 PVC compound, oil-resistant, flame-retardant and UV- resistant. RAL 6018 green color
Temperatura di esercizio Temperature range	-30°C, +80°C
Tensione nominale Voltage rating	300 V
Resistenza max. c.c. Max DC resistance	56,40 Ω/km
Impedenza caratteristica Characteristic impedance	100 Ω
Capacità Capacitance	52 pF/m
Resistenza dielettrica Dielectric strength	1500 Vac x 1 min (cond./cond. - cond./shield)
Raggio di curvatura Bending radius	8 volte diametro esterno del cavo 8 x cable outer diameter
Riferimenti normativi costruttivi Standards of construction	Flame res.: IEC 60332-1-2, UL 1581 par. 1090, 1100 (FT2) Oil res.: IEC 60811-2-1, EN 50363-4-1 type TM5, ASTM IRM902 UV res.: UL 1581 par. 1200 Other: IEC 61156-5, EN 50288-2-1, UL 758, CSA AWM I/II, A/B, cURus AWM Style 20601 or 2464
Riferimenti normativi d'impiego Standards of use	ANSI/NFPA 79, UL 508a, CSA C22.1 (CE Code), CSA C22.2 No.286, Style 20601 or 2464

Marcatura - Marking

TEKIMA 77010 "PROFINET" – CE (1x4x0,34) mm² 80°C 300 V IEC 60332-1-2 – c(UR)us E314444 AWM Style 20601 (1x4x22) AWG 80°C 300 V AWM Class I/II A/B FT2 – 100 Ohm – (prod.reference) = (metric) =

Codifiche e dimensioni - Coding and dimensions

Codice Code	N. conduttori x sezione Num. conductors x Size [mm²]	N. conduttori x sezione Num. conductors x Size [AWG]	Diametro Diameter [mm]	Peso Weight [kg/km]
CVFD0001_77010_VE	[1X(4X0,35)]	[1X(4X22)]	6,5	74

SERIES
77100

Cavi per trasmissione dati Profinet

Profinet data transmission cables

Posa mobile - Dynamic application



Impiego - Use

Profinet è lo standard industriale Ethernet del consorzio Profibus e Profinet, tale sistema utilizza il protocollo TCP/IP consentendo una comunicazione in tempo reale con dispositivi industriali sempre più avanzati. Il cavo è progettato per impieghi in posa mobile con ottima resistenza alle sollecitazioni meccaniche, alle basse temperature ed ai più utilizzati olii lubrificanti e fluidi industriali.

Profinet is the Ethernet industrial standard of Profibus and Profinet association. This system employs the TCP/IP protocol permitting a real-time communication with advanced industrial devices. The cable has been planned for dynamic application, it exhibits a good resistance to the mechanical stress, to the low temperatures and to the most used industrial oils and fluids.

Informazione. Si effettua, su richiesta, un servizio aggiuntivo di taglio a misura certificato UL ("Processed Wire").

Information. An additional UL certified cut-to-length service is carried out on request ("Processed Wire").

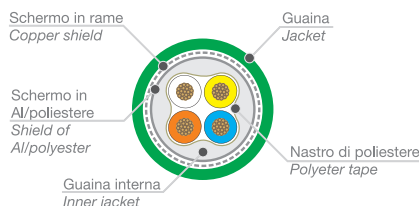

Dati tecnici - Technical data

Caratteristica - Characteristics	Valore/proprietà - Value/property
Categoria Category	Profinet SF/UTP Cat.5e <i>Profinet SF/UTP Cat.5e</i>
Conduttore Conductor	Rame rosso 0,38 mm ² (19x0,16 mm) <i>Bare copper 0,38 mm² (19x0,16 mm)</i>
Isolamento Insulation	TKblend®-L
Conduttori Conductors	Twistati (bianco, blu, giallo, arancione) <i>Twisted (White, Blue, Yellow, Orange)</i>
Guaina interna Internal jacket	TPE
Schermatura Shield	Nastro in alluminio/poliestere e treccia di rame stagnato con ricopertura nom. 85% <i>Aluminum/polyester tape and tinned copper braid, nom. coverage 85%</i>
Guaina Jacket	PUR antiolio, antifiama e resistente ai raggi UV. Colore verde RAL 6018 <i>PUR oil-resistant, flame-retardant and UV-resistant. RAL 6018 green color</i>
Temperatura di esercizio Temperature range	-40°C, +80°C (posa fissa); -20°C, +60°C (posa mobile) <i>-40°C, +80°C (fixed application); -20°C, +60°C (dynamic application)</i>
Tensione nominale Voltage rating	300 V
Resistenza max. c.c. Max DC resistance	59,4 Ω/km
Impedenza caratteristica Characteristic impedance	100 Ω
Capacità Capacitance	52 pF/m
Raggio di curvatura Bending radius	8 volte diametro esterno del cavo (posa fissa), 12 volte diametro esterno del cavo (posa mobile) <i>8 x cable outer diameter (fixed), 12 x cable outer diameter (not fixed)</i>
Velocità Speed	180 m/min
Accelerazione Acceleration	3 m/s ²
Riferimenti normativi costruttivi Standards of construction	Flame res.: IEC 60332-1, UL 1581 par. 1090 and par. 1100 (FT2) Oil res.: IEC 60811-2-1, ICEA S-82-552, IRM 901, 902 Other: UL 1581, IEC 61156-6, EN 50288-1, EN 50288-2-2, ISO/IEC 11801, UL 758, CSA AWM I/II A/B, cURus AWM Style 20978 or Style 20549
Riferimenti normativi d'impiego Standards of use	ANSI/NFPA 79, UL 508a, CSA C22.1 (CE Code), CSA C22.2 No.286, Style 20978 or Style 20549

Marcatura - Marking

TEKIMA 77100 "PROFINET" – CE (1x4x0,38) mm² 80°C 300 V IEC 60332-1 – c(UR)us E314444 AWM Style 20978 (1x4x22) AWG 80°C 300 V AWM Class I/II A/B FT2 – 100 Ohm – (prod.reference) = (metric) =

Codifiche e dimensioni - Coding and dimensions

Codice Code	N. conduttori x sezione Num. conductors x Size [mm ²]	N. conduttori x sezione Num. conductors x Size [AWG]	Diametro Diameter [mm]	Peso Weight [kg/km]
CVFD0001_77100_VE	[1X(4X0,38)]	[1X(4X22)]	6,7	63

SERIES
78000

Cavi per trasmissione dati tipo DRIVE-CLiQ

DRIVE-CLiQ data transmission cables



Posa fissa - Fixed application

c US

RoHS



Impiego - Use

Il cavo per trasmissione dati DRIVE-CLiQ in posa fissa è utilizzato per il collegamento di apparecchiature industriali. DRIVE-CLiQ è un'interfaccia encoder aperta che consente agli utenti di scegliere il sistema di misura ottimale per la loro applicazione. Con questa interfaccia è possibile collegare encoder a sistemi di misura magnetici/induttivi, sensori magnetostrittivi, laser. Il cavo, la cui guaina è a base di poliuretano, garantisce ottime prestazioni meccaniche, resistenza agli olii e alla fiamma.

The DRIVE-CLiQ data communication cable for fixed application is used in connection of industrial equipment. DRIVE-CLiQ is an open encoder interface that allows users to select the right measuring system for their application. With this interface it is possible to connect encoders to magnetic/inductive, magnetostrictive sensors, lasers measuring systems. This cable, made of a polyurethane jacket, grants very good mechanical performance, oil and flame resistance.

Informazione. Si effettua, su richiesta, un servizio aggiuntivo di taglio a misura certificato UL ("Processed Wire").

Information. An additional UL certified cut-to-length service is carried out on request ("Processed Wire").

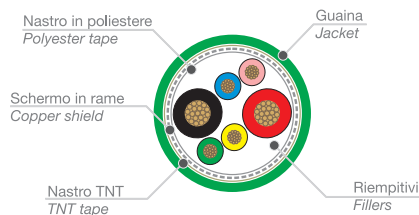

Dati tecnici - Technical data

Caratteristica - Characteristics	Valore/proprietà - Value/property
Conduttore <i>Conductor</i>	Rame rosso. Conduttori 0,14 mm ² (7x0,16 mm) secondo VDE 0295 Cl.5. Conduttori 0,35 mm ² (7x0,254 mm) secondo VDE 0295 Cl.2. <i>Bare copper.</i> Conduttori 0,14 mm ² (7x0,16 mm) acc. to VDE 0295 Cl.5. Conduttori 0,35 mm ² (7x0,254 mm) acc. to VDE 0295 Cl.2.
Isolamento <i>Insulation</i>	TKblend®-YP
Conduttori <i>Conductors</i>	Twistati, colorazione rosso/nero (0,35 mm ²), giallo/verde e rosa/blu (0,14 mm ²). <i>Twisted, red/black colors (0,35 mm²), yellow/green and pink/blue (0,14 mm²)</i>
Nastratura interna <i>Inner taping</i>	Nastro PET sotto schermo <i>PET tape under shield</i>
Schermatura <i>Shield</i>	Treccia di rame stagnato con ricopertura nom. 85% <i>Tinned copper braid, nom. coverage 85%</i>
Nastratura esterna <i>Outer taping</i>	Nastro TNT sopra schermo <i>TNT tape over shield</i>
Guaina <i>Jacket</i>	PUR antifiamma, antioil. Colore verde simile RAL 6018. <i>PUR, oil-resistant and flame-resistant. Similar to RAL 6018 green color.</i>
Temperatura di esercizio <i>Temperature range</i>	-50°C, +80°C (posa fissa); -25°C, +80°C (posa mobile non ciclica) <i>-50°C, +80°C (fixed); -25°C, +80°C (not fixed)</i>
Tensione nominale <i>Voltage rating</i>	300 V
Tensione di prova <i>Test voltage</i>	1500 V x 1 min
Raggio di curvatura <i>Bending radius</i>	5 volte diametro esterno del cavo (posa fissa), 10 volte diametro esterno del cavo (posa mobile non ciclica) <i>5 x cable outer diameter (fixed), 10 x cable outer diameter (not fixed)</i>
Riferimenti normativi costruttivi <i>Standards of construction</i>	Flame res.: UL FT1 Oil res.: EN 50363-10 Other: IEC 60754-1, EN 50267-2-1, VDE 0472-815, UL 1581, EN 50396, UL 758, CSA AWM I/II A/B, cURus AWM Style 20233
Riferimenti normativi d'impiego <i>Standards of use</i>	ANSI/NFPA 79, UL 508a, CSA C22.1 (CE Code), CSA C22.2 No.286, Style 20233

Marcatura - Marking

TEKIMA 78000 – CE (2x2x0,14+2x0,35) mm² 80°C 300 V – c(UR)us E314444 AWM Style 20233 (2x2x26+2x22) AWG 80°C 300 V AWM Class I/II A/B FT1 – (prod.reference) = (metric) =

Codifiche e dimensioni - Coding and dimensions

Codice <i>Code</i>	N. conduttori x sezione <i>Num. conductors x Size [mm²]</i>	N. conduttori x sezione <i>Num. conductors x Size [AWG]</i>	Diametro <i>Diameter [mm]</i>	Peso <i>Weight [kg/km]</i>
CVFD0001_78000_VE	(2x2x0,14+2x0,35)	(2x2x26+2x22)	6,8	65

SERIES
78100

Cavi per trasmissione dati tipo DRIVE-CLiQ

DRIVE-CLiQ data transmission cables

Posa mobile - Dynamic application



Impiego - Use

Il cavo per trasmissione dati DRIVE-CLiQ in posa mobile è utilizzato per il collegamento di apparecchiature industriali. DRIVE-CLiQ è un'interfaccia encoder aperta che consente agli utenti di scegliere il sistema di misura ottimale per la loro applicazione. Con questa interfaccia è possibile collegare encoder a sistemi di misura magnetici/induttivi, sensori magnetostrittivi, laser. Il cavo, la cui guaina è a base di poliuretano, garantisce ottime prestazioni meccaniche, resistenza agli olii e alla fiamma.

The DRIVE-CLiQ data communication cable for mobile application is used in connection of industrial equipment. DRIVE-CLiQ is an open encoder interface that allows users to select the right measuring system for their application. With this interface it is possible to connect encoders to magnetic/inductive, magnetostrictive sensors, lasers measuring systems. This cable, made of a polyurethane jacket, grants very good mechanical performance, oil and flame resistance.

Informazione. Si effettua, su richiesta, un servizio aggiuntivo di taglio a misura certificato UL ("Processed Wire").

Information. An additional UL certified cut-to-length service is carried out on request ("Processed Wire").

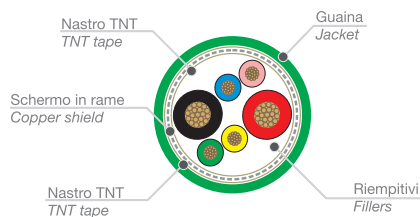

Dati tecnici - Technical data

Caratteristica - Characteristics	Valore/proprietà - Value/property
Conduttore <i>Conductor</i>	Rame rosso. Conduttori 0,15 mm ² (19x0,10 mm) secondo VDE 0295 Cl.6 Conduttori 0,34 mm ² (19x0,15 mm) secondo VDE 0295 Cl.5. <i>Bare copper.</i> Conduttori 0,15 mm ² (19x0,10 mm) acc. to VDE 0295 Cl.6. Conduttori 0,34 mm ² (19x0,15 mm) acc. to VDE 0295 Cl.5.
Isolamento <i>Insulation</i>	TKblend®-YP
Conduttori <i>Conductors</i>	Twistati, colorazione rosso/nero (0,34 mm ²), giallo/verde e rosa/blu (0,15 mm ²). <i>Twisted, red/black colors (0,34 mm²), yellow/green and pink/blue (0,15 mm²)</i>
Nastratura interna <i>Inner taping</i>	Nastro TNT sotto schermo <i>TNT tape under shield</i>
Schermatura <i>Shield</i>	Treccia di rame stagnato con ricopertura nom. 85% <i>Tinned copper braid, nom. coverage 85%</i>
Nastratura esterna <i>Outer taping</i>	Nastro TNT sopra schermo <i>TNT tape over shield</i>
Guaina <i>Jacket</i>	PUR antifiamma, antiolio. Colore verde simile RAL 6018. <i>PUR, oil-resistant and flame-resistant. Similar to RAL 6018 green color.</i>
Temperatura di esercizio <i>Temperature range</i>	-50°C, +80°C (posa fissa); -25°C, +80°C (posa mobile non ciclica); -5°C, +60°C (posa in catena) <i>-50°C, +80°C (fixed); -25°C, +80°C (not fixed); -5°C, +60°C (drag chain)</i>
Tensione nominale <i>Voltage rating</i>	300 V
Tensione di prova <i>Test voltage</i>	1500 V x 1 min
Velocità <i>Speed</i>	220 m/s
Accelerazione <i>Acceleration</i>	10 m/s ²
Raggio di curvatura <i>Bending radius</i>	5 volte diametro esterno del cavo (posa fissa), 10 volte diametro esterno del cavo (posa mobile non ciclica) <i>5 x cable outer diameter (fixed), 10 x cable outer diameter (not fixed)</i>
Riferimenti normativi costruttivi <i>Standards of construction</i>	Flame res.: UL FT1 Oil res.: EN 50363-10 Other: IEC 60754-1, EN 50267-2-1, VDE 0472-815, UL 1581, EN 50396, UL 758, CSA AWM I/II A/B, cURus AWM Style 20233
Riferimenti normativi d'impiego <i>Standards of use</i>	ANSI/NFPA 79, UL 508a, CSA C22.1 (CE Code), CSA C22.2 No.286, Style 20233

Marcatura - Marking

TEKIMA 78100 – CE (2x2x0,15+2x0,34) mm² 80°C (fix) 60°C (mobile) 300 V – c(UR)us E314444 AWM Style 20233 (2x2x26+2x22) AWG 80°C (fix) 60°C (mobile) 300 V AWM Class I/II A/B FT1 – (prod.reference) = (metric) =

Codifiche e dimensioni - Coding and dimensions

Codice <i>Code</i>	N. conduttori x sezione <i>Num. conductors x Size [mm²]</i>	N. conduttori x sezione <i>Num. conductors x Size [AWG]</i>	Diametro <i>Diameter [mm]</i>	Peso <i>Weight [kg/km]</i>
CVFD0001_78100_VE	(2x2x0,15+2x0,34)	(2x2x26+2x22)	6,8	69



Impiego - Use

Sono cavi schermati progettati per impiego fisso a bordo macchina o per impieghi mobili occasionali e non ciclici. Vengono normalmente utilizzati per l'equipaggiamento di apparecchiature destinate sia al mercato Europeo (CE) che al mercato nord americano (UL). La loro buona resistenza all'olio ed all'abrasione ne permette l'utilizzo in collegamenti statici senza particolari protezioni e senza che ne vengano compromesse le qualità elettriche e meccaniche originali. L'ottima resistenza alla fiamma li rende inoltre idonei alla posa in qualsiasi ambiente industriale. La marcatura metrica stampigliata sulla guaina del cavo ne favorisce la lavorazione e l'installazione.

Machine tool wire cables produced for fixed applications or not-cyclical and not-repetitive mobile uses. They are used for equipment meant for the European (EC) and North American (UL) markets. Their good oil and abrasion resistance permit their use in static connections without particular protections and without compromising the original electrical and mechanical properties. The good flame resistance makes them suitable for the installation in any industrial environment. The metric marked on the jacket allows an easier processing and installation of the cable.

Informazione. Si effettua, su richiesta, un servizio aggiuntivo di taglio a misura certificato UL ("Processed Wire").

Information. An additional UL certified cut-to-length service is carried out on request ("Processed Wire").

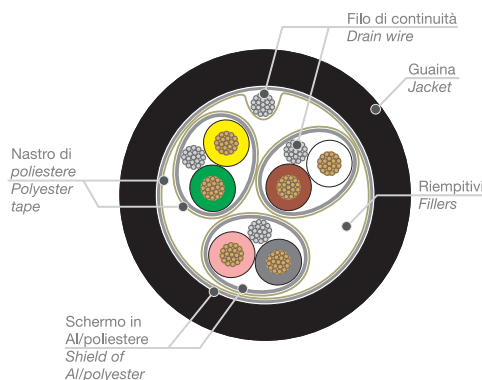

Dati tecnici - Technical data

Caratteristica - Characteristics	Valore/proprietà - Value/property
Conduttore <i>Conductor</i>	Trefolo in rame rosso <i>Bare copper</i>
Isolamento <i>Insulation</i>	TKblend®-R
Distinzione conduttori <i>Conductor distinction</i>	Twistati a coppie: (Bianco, Marrone); (Verde, Giallo); (Grigio, Rosa) <i>Twisted: (White, Brown); (Green, Yellow); (Gray, Pink)</i>
Schermatura coppie <i>Pairs shield</i>	Nastro alluminio/poliestere (con ricopertura 100%), filo di continuità 14x0,15 mm e nastro protettivo di PET. <i>Aluminum/polyester (coverage 100%), drain wire 14x0,15 mm and protective PET tape.</i>
Schermatura totale <i>Total shield</i>	Nastro protettivo di PET, filo di continuità 14x0,15 mm e nastro alluminio/poliestere (con ricopertura 100%). <i>Protective PET tape, drain wire 14x0,15 mm and aluminum/polyester (coverage 100%).</i>
Guaina <i>Jacket</i>	Mescola di PVC. Colore nero. <i>PVC compound. Black color.</i>
Temperatura di esercizio <i>Temperature range</i>	+80°C -25°C (posa fissa); -5°C (mobile ⁽¹⁾) -25°C (fixed); -5°C (not fixed ⁽¹⁾)
Tensione nominale <i>Voltage rating</i>	300 V
Tensione di prova <i>Test voltage</i>	2000 V x 1 min
Resistenza elettrica <i>Electrical resistance</i>	<75,37 Ω/km
Raggio di curvatura <i>Bending radius</i>	5 volte diametro esterno del cavo <i>5 x cable outer diameter</i>
Riferimenti normative costruttivi <i>Standards of construction</i>	Flame res.: UL VW-1, CSA FT1, IEC 60332-1, CEI 20-35 Oil res.: ISO 6722 Other: CEI 20-52, IEC 60344, IEC 60885-1, UL 758, AWM I/II A/B, UL AWM Style 2464
Riferimenti normative di impiego <i>Standards of use</i>	ANSI/NFPA 79, UL 508a, Style 2464

(1) Per impiego mobile con movimenti scarsamente ripetitivi.

(1) For mobile use with scarcely repetitive and non-cyclical movements.

Marcatura - Marking

TEKIMA CVFS0001_0301S_NE - CE (3x2x0,25) mm² 80°C 300 V CEI 20-35 IEC 60332-1- c(UR)us E314444 AWM Style 2464 (3x2x24) AWG 80°C 300 V VW-1 - Class I/II A/B FT1 - (prod.reference) = (metric) =

Codifiche e dimensioni - Coding and dimensions

Codice <i>Code</i>	N. conduttori x sezione <i>Num. conductors x Size [mm²]</i>	N. conduttori x sezione <i>Num. conductors x Size [AWG]</i>	Diametro <i>Diameter [mm]</i>	Peso <i>Weight [kg/km]</i>
CVFS0001_0301S_NE	(3x(2x0,25))	(3x(2x24))	7,0	58



Impiego - Use

Sono cavi schermati progettati per impiego fisso a bordo macchina o per impieghi mobili occasionali e non ciclici. Vengono normalmente utilizzati per l'equipaggiamento di apparecchiature destinate al mercato Europeo (CE). La loro buona resistenza all'olio ed all'abrasione ne permette l'utilizzo in collegamenti statici senza particolari protezioni e senza che ne vengano compromesse le qualità elettriche e meccaniche originali. L'ottima resistenza alla fiamma li rende inoltre idonei alla posa in qualsiasi ambiente industriale. La marcatura metrica stampigliata sulla guaina del cavo ne favorisce la lavorazione e l'installazione.

Machine tool wire cables produced for fixed applications or not-cyclical and not-repetitive mobile uses. They are used for equipment meant for the European (EC) market. Their good oil and abrasion resistance permit their use in static connections without particular protections and without compromising the original electrical and mechanical properties. The good flame resistance makes them suitable for the installation in any industrial environment. The metric marked on the jacket allows an easier processing and installation of the cable.

Informazione. Si effettua, su richiesta, un servizio aggiuntivo di taglio a misura certificato UL ("Processed Wire").
Information. An additional UL certified cut-to-length service is carried out on request ("Processed Wire").

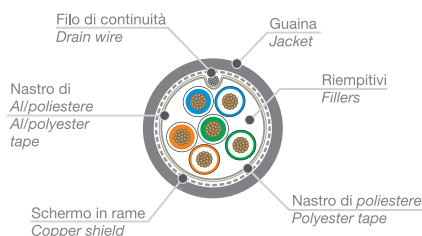

Dati tecnici - Technical data

Caratteristica - Characteristics	Valore/proprietà - Value/property
Conduttore <i>Conductor</i>	Trefolo in rame stagnato <i>Tin copper</i>
Isolamento <i>Insulation</i>	TKblend®-L
Distinzione conduttori <i>Conductor distinction</i>	Twistati a coppie: (Bianco con anelli blu, Blu con anelli bianchi); (Bianco con anelli arancione, Arancione con anelli bianchi); (Bianco con anelli verdi, Verde con anelli bianchi) <i>Twisted: (White with blue rings, Blue with white rings); (White with orange rings, Orange with white rings); (White with green rings, Green with white rings)</i>
Schematura totale <i>Total shield</i>	Nastro alluminio/poliestere (con ricopertura 100%), protettivo di PET, filo di continuità 7x0,13 mm e schermo di rame stagnato (con ricopertura nom. 65%). <i>Protective aluminum/polyester (coverage 100%), drain wire 7x0,13 mm and tin copper shield (nom. coverage 65%).</i>
Guaina <i>Jacket</i>	Mescola di PVC. Colore grigio RAL 7001. <i>PVC compound. Gray color RAL 7001.</i>
Temperatura di esercizio <i>Temperature range</i>	+80°C (posa fissa); +70°C (mobile ⁽¹⁾) -30°C (posa fissa); -5°C (mobile ⁽¹⁾) <i>+80°C (fixed); +70°C (not fixed⁽¹⁾) -25°C (fixed); -5°C (not fixed⁽¹⁾)</i>
Tensione nominale <i>Voltage rating</i>	30 V
Resistenza elettrica <i>Electrical resistance</i>	<206,5 Ω/km
Impedenza caratteristica <i>Nominal impedance</i>	120 Ω
Capacità <i>Capacitance</i>	36 pF/m
Raggio di curvatura <i>Bending radius</i>	10 volte diametro esterno del cavo (15 volte diametro esterno del cavo per movimentazioni non continue) <i>10 x cable outer diameter (15 x cable outer diameter for non-cyclical mobile uses)</i>
Riferimenti normative costruttivi <i>Standards of construction</i>	Flame res.: IEC 60332-1 Oil res.: ISO 6722

(1) Per impiego mobile con movimenti scarsamente ripetitivi.

(1) For mobile use with scarcely repetitive and non-cyclical movements.

Marcatura - Marking

TEKIMA CVFS0040_0301S - CE (3x2x0,09) mm² 30 V IEC 60332-1 - (prod.reference) = (metric) =

Codifiche e dimensioni - Coding and dimensions

Codice <i>Code</i>	N. conduttori x sezione <i>Num. conductors x Size [mm²]</i>	N. conduttori x sezione <i>Num. conductors x Size [AWG]</i>	Diametro <i>Diameter [mm]</i>	Peso <i>Weight [kg/km]</i>
CVFS0040_0301S_GR	(3x(2x0,09))	(3x(2x28))	6,5	47



Impiego - Use

Sono cavi schermati progettati per impiego fisso a bordo macchina o per impieghi mobili occasionali e non ciclici. Vengono normalmente utilizzati per l'equipaggiamento di apparecchiature destinate sia al mercato Europeo (CE) che ai mercati nord americani (UL) e canadese (CSA). La loro buona resistenza all'olio ed all'abrasione ne permette l'utilizzo in collegamenti statici senza particolari protezioni e senza che ne vengano compromesse le qualità elettriche e meccaniche originali. L'ottima resistenza alla fiamma li rende inoltre idonei alla posa in qualsiasi ambiente industriale. La marcatura metrica stampigliata sulla guaina del cavo ne favorisce la lavorazione e l'installazione.

Machine tool wire cables produced for fixed applications or not-cyclical and not-repetitive mobile uses. They are used for equipment meant for the European (EC), North American (UL) and Canadian (CSA) markets. Their good oil and abrasion resistance permit their use in static connections without particular protections and without compromising the original electrical and mechanical properties. The good flame resistance makes them suitable for the installation in any industrial environment. The metric marked on the jacket allows an easier processing and installation of the cable.

Informazione. Si effettua, su richiesta, un servizio aggiuntivo di taglio a misura certificato UL ("Processed Wire").

Information. An additional UL certified cut-to-length service is carried out on request ("Processed Wire").

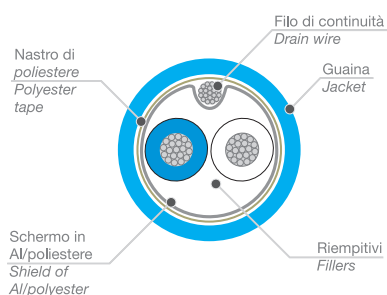

Dati tecnici - Technical data

Caratteristica - Characteristics	Valore/proprietà - Value/property
Conduttore <i>Conductor</i>	Trefolo in rame stagnato <i>Tin copper</i>
Isolamento <i>Insulation</i>	TKblend®-L
Distinzione conduttori <i>Conductor distinction</i>	Twistati: (Blu, Naturale) <i>Twisted: (Blue, Natural)</i>
Schematura totale <i>Total shield</i>	Nastro alluminio/poliestere (con ricopertura 100%), filo di continuità 7x0,25 mm e nastro protettivo di PET. <i>Aluminum/polyester (coverage 100%), drain wire 7x0,25 mm and protective PET tape.</i>
Guaina <i>Jacket</i>	Mescola di PVC. Colore blu RAL 5015. <i>PVC compound. Blue color RAL 5015.</i>
Temperatura di esercizio <i>Temperature range</i>	+80°C -20°C (posa fissa); -5°C (mobile ⁽¹⁾) -20°C (fixed); -5°C (not fixed ⁽¹⁾)
Tensione nominale <i>Voltage rating</i>	300 V
Resistenza elettrica <i>Electrical resistance</i>	<87,2 Ω/km
Impedenza caratteristica <i>Nominal impedance</i>	120 Ω
Capacità <i>Capacitance</i>	40 pF/m
Raggio di curvatura <i>Bending radius</i>	10 volte diametro esterno del cavo <i>10 x cable outer diameter</i>
Riferimenti normative costruttivi <i>Standards of construction</i>	Flame res.: UL HFT, CSA FT1, IEC 60332-1 Oil res.: ISO 6722 Other: IEC 60344, UL 758, CSA AWM I/II A/B, cURus AWM Style 2095
Riferimenti normative di impiego <i>Standards of use</i>	ANSI/NFPA 79, UL 508a, CSA C22.1 (CE Code), CSA C22.2 No.286, Style 2095

(1) Per impiego mobile con movimenti scarsamente ripetitivi.

(1) For mobile use with scarcely repetitive and non-cyclical movements.

Marcatura - Marking

TEKIMA CVFS0050_0301S – CE (2x0,22) mm² 80°C 300 V IEC 60332-1 – c(UR)us AWM Style 2095 (2x24) AWG 80°C 300 V E314444 – AWM Class III A/B 80°C 300V FT1 – (prod.reference) = (metric) =

Codifiche e dimensioni - Coding and dimensions

Codice <i>Code</i>	N. conduttori x sezione <i>Num. conductors x Size [mm²]</i>	N. conduttori x sezione <i>Num. conductors x Size [AWG]</i>	Diametro <i>Diameter [mm]</i>	Peso <i>Weight [kg/km]</i>
CVFS0050_0301S_BL	(2x0,22)	(2x24)	6,1	34



Impiego - Use

Sono cavi schermati progettati per impiego fisso a bordo macchina o per impieghi mobili occasionali e non ciclici. Vengono normalmente utilizzati per l'equipaggiamento di apparecchiature destinate sia al mercato Europeo (CE) che ai mercati nord americani (UL) e canadese (CSA). La loro buona resistenza all'olio ed all'abrasione ne permette l'utilizzo in collegamenti statici senza particolari protezioni e senza che ne vengano compromesse le qualità elettriche e meccaniche originali. L'ottima resistenza alla fiamma li rende inoltre idonei alla posa in qualsiasi ambiente industriale. La marcatura metrica stampigliata sulla guaina del cavo ne favorisce la lavorazione e l'installazione.

Machine tool wire cables produced for fixed applications or not-cyclical and not-repetitive mobile uses. They are used for equipment meant for the European (EC), North American (UL) and Canadian (CSA) markets. Their good oil and abrasion resistance permit their use in static connections without particular protections and without compromising the original electrical and mechanical properties. The good flame resistance makes them suitable for the installation in any industrial environment. The metric marked on the jacket allows an easier processing and installation of the cable.

Informazione. Si effettua, su richiesta, un servizio aggiuntivo di taglio a misura certificato UL ("Processed Wire").

Information. An additional UL certified cut-to-length service is carried out on request ("Processed Wire").

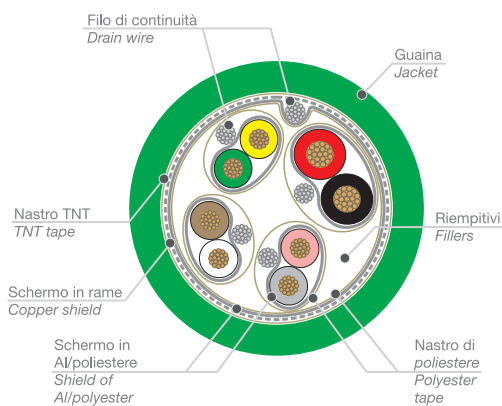

Dati tecnici - Technical data

Caratteristica - Characteristics	Valore/proprietà - Value/property
Conduttore <i>Conductor</i>	Trefolo in rame rosso <i>Bare copper</i>
Isolamento <i>Insulation</i>	TKblend®-L
Distinzione conduttori <i>Conductor distinction</i>	Coppia 0,5 mm ² twistata: (Rosso, Nero) Coppie 0,22 mm ² twistate: (Bianco, Marrone); (Verde, Giallo); (Grigio, Rosa) <i>Twisted pair 0,5 mm²: (Red, Black)</i> <i>Twisted pair 0,22 mm²: (White, Brown); (Green, Yellow); (Gray, Pink)</i>
Schermatura coppie <i>Pairs shield</i>	Nastro alluminio/poliestere (con ricopertura 100%), filo di continuità 7x0,20 mm e nastro protettivo di PET. <i>Aluminum/polyester (coverage 100%), drain wire 7x0,20 mm and protective PET tape.</i>
Schermatura totale <i>Total shield</i>	Nastro alluminio/poliestere (con ricopertura 100%), protettivo di PET, filo di continuità 7x0,20 mm e schermo di rame stagnato (con ricopertura nom. 85%). Nastro di TNT sul totale. <i>Protective aluminum/polyester (coverage 100%), drain wire 7x0,20 mm and tin copper shield (nom. coverage 85%). TNT tape over total assembly.</i>
Guaina <i>Jacket</i>	Mescola di PVC. Colore verde RAL 6018. <i>PVC compound. Green color RAL 6018.</i>
Temperatura di esercizio <i>Temperature range</i>	+80°C -25°C ⁽²⁾ (posa fissa); -5°C (mobile ⁽¹⁾) <i>-25°C⁽²⁾ (fixed); -5°C (not fixed⁽¹⁾)</i>
Tensione nominale <i>Voltage rating</i>	300 V
Tensione di prova <i>Test voltage</i>	2000 V x 1 min
Resistenza elettrica <i>Electrical resistance</i>	Coppia 0,5 mm ² : <37,10 Ω/km; Coppie 0,22 mm ² : <84,79 Ω/km <i>Pair 0,5 mm²: <37,10Ω/km; Pair 0,22 mm²: <84,79 Ω/km</i>
Raggio di curvatura <i>Bending radius</i>	5 volte diametro esterno del cavo <i>5 x cable outer diameter</i>
Riferimenti normative costruttivi <i>Standards of construction</i>	Flame res.: UL Vertical flame, CSA FT2 or FT1, IEC 60332-1, CEI 20-35 Oil res.: ISO 6722 Other: CEI 20-52, UL 758, CSA AWM I/II A/B, cURus AWM Style 2464 or 20601
Riferimenti normative di impiego <i>Standards of use</i>	ANSI/NFPA 79, UL 508a, CSA C22.1 (CE Code), CSA C22.2 No.286, Style 2464 or 20601

(1) Per impiego mobile con movimenti scarsamente ripetitivi.

(1) For mobile use with scarcely repetitive and non-cyclical movements.

(2) Su richiesta prodotto speciale fino a -40°C.

(2) On request special product up to -40°C.

Marcatura - Marking

TEKIMA 0321S - CE (2x0,5 + 3x(2x0,22)) mm² 80°C 300 V CEI 20-35/IEC 60332-1 - c(UR)us E314444 AWM Style 20601 (2x21 + 3x(2x24)) AWG 80°C 300 V - AWM Class I/II A/B 80°C 300V FT2 - (prod.reference) = (metric) =

Codifiche e dimensioni - Coding and dimensions

Codice <i>Code</i>	N. conduttori x sezione <i>Num. conductors x Size [mm²]</i>	N. conduttori x sezione <i>Num. conductors x Size [AWG]</i>	Diametro <i>Diameter [mm]</i>	Peso <i>Weight [kg/km]</i>
CVFS0003_0321S_D1	((2x0,50)+3x(2x0,22))	((2x21)+3x(2x24))	9,5	116



Cavi multipolari “Hybrid”
Multi-conductor “Hybrid” cables

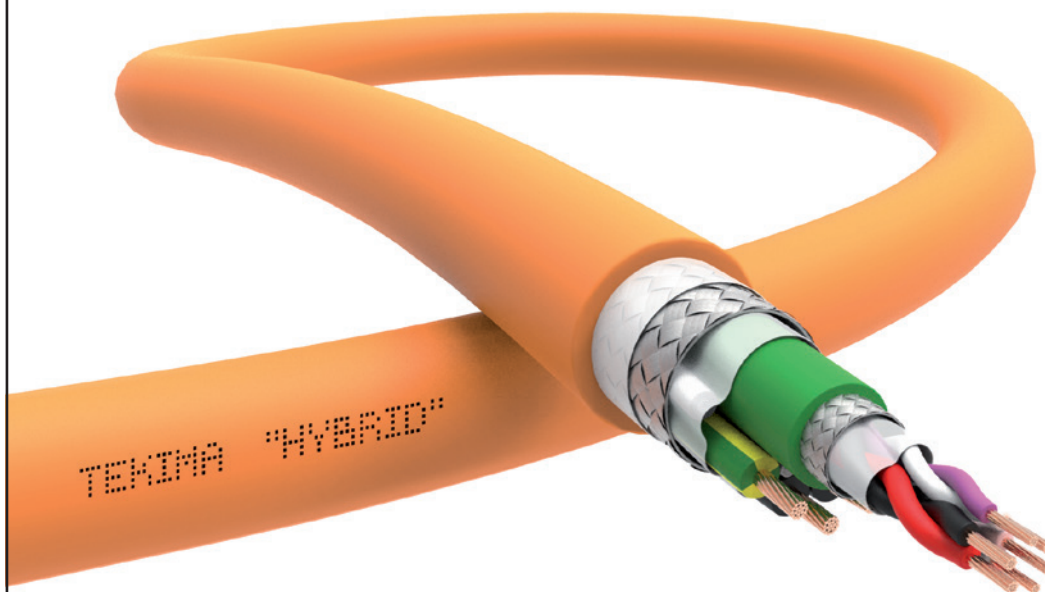

Impiego - Use

L'utilizzo delle tecnologie digitali nel controllo dei motori per automazione industriale sta subendo una decisa accelerazione.

L'integrazione delle due componenti essenziali (potenza e controllo) necessarie al funzionamento di un motore elettrico di ultima generazione, prevede l'aggregazione in un unico cavo dei conduttori di alimentazione e di quelli necessari alle comunicazioni digitali.

Coniugare grandezze elettriche assai diverse e parametri elettrici di altissima affidabilità in un unico prodotto rappresenta oggi il nuovo traguardo nella costruzione dei cavi ibridi.

Realizziamo il tuo cavo personalizzabile in:

- > Tipologia di **comunicazione**
- > **Certificazioni**
- > **Installazione**, posa fissa/mobile
- > **Condizioni operative**
- > **Dimensioni**
- > **Colorazioni**



Per maggiori informazioni scrivi a sales@tekima.com

The use of digital technologies in motors' control for industrial automation is undergoing a decisive acceleration.

The integration of the two essential components (power and control) necessary for the operation of a latest generation electric motor, involves the aggregation in a single cable of the power supply conductors and those necessary for digital communications.

Combining very different electrical quantities and extremely reliable electrical parameters in a single product represents today the new goal in the construction of hybrid cables.

We create your own cables. Customizable in:

- > Type of **communication**
- > **Certifications**
- > **Installation**, fixed / mobile installation
- > **Operating conditions**
- > **Dimensions**
- > **Colors**



For more information please contact sales@tekima.com



Cavi “Made in USA”
“Made in USA” cables

SERIES
80010
80020

Flexible cord type S e SJ



“UL-CSA Listed”



Impiego - Use

Cavi flessibili UL Listed costruiti per gli usi specificati dall'articolo 400 del ANSI/NFPA 70 “National Electrical Code” (NEC). I cavi type S e SJ sono utilizzati per apparecchiature industriali e di processo, gru e paranchi, motori e macchinari associati, luci portatili, carica batterie, per alimentazione lavatrici e frigoriferi. I cavi type S possono essere utilizzati in zone a pericolo di esplosione Class I/II secondo quanto specificato dagli Art. 501.140 e 502.140 seguendo le metodologie di cablaggio definite rispettivamente negli Art. 501.10 e 502.10.

UL Listed flexible cables built for the uses specified by the Art. 400 of ANSI/NFPA 70 “National Electrical Code” (NEC). S and SJ type cables are used for industrial and processing equipment, cranes and hoists, motors and associated machinery, portable lamps, battery chargers, washmachine and refrigerator power supply. Type S cable can be used in Class I/II hazardous locations according to the specifications of the Art. 501.140 and 502.140 following the harness methods specified by Art. 501.10 and 502.10.

Informazione. Si prega di chiedere all'ufficio commerciale la possibilità del servizio aggiuntivo di taglio a misura certificato UL (“Processed Wire”).

Information. Please ask the sales department for the possibility of an additional UL certified cut-to-size service (“Processed Wire”).

Dati tecnici - Technical data

Caratteristica - Characteristics	Valore/proprietà - Value/property
Identificazione <i>Identification</i>	Type S Hard service cord Type SJ Junior hard service cord
Tipologia <i>Type</i>	S e SJ
Isolamento <i>Insulation</i>	Termoindurente <i>Thermoset</i>
Numero di conduttori <i>Number of conductor</i>	2÷4 Type S 2÷4 Type SJ
Sezione <i>Size</i>	18÷10 AWG
Guaina <i>Jacket</i>	Termoindurente, colore nero <i>Thermoset, black color</i>
Tensione <i>Voltage</i>	600V per la versione Type S - 600V for Type S 300V per la versione Type SJ - 300V for Type SJ
Temperatura di esercizio <i>Temperature range</i>	-40°C; + 60°C
Utilizzo <i>Use</i>	Type S Pendant or portable. Damp locations. Extra hard usage. Type SJ Pendant or portable. Damp locations. Hard usage.
Riferimenti normativi costruttivi <i>Standards of construction</i>	UL/CSA Approvals: Class 1, Div. 1 & Div. 2 NEC Art. 400, 501, 502; CSA C22.1 (CE Code); C22.2 No. 49; UL 62
Riferimenti normativi d'impiego <i>Standards of use</i>	NFPA 70 (NEC) Art. 400, 501, 502; CSA C22.1 (CE Code)

Per assicurare la corretta destinazione d'uso definita nel NEC si è deciso di mantenere la versione linguistica originaria.

Codifiche e dimensioni - Coding and dimensions

Codice <i>Code</i>	Type	Numero di conduttori <i>Number of conductors</i>	Sezione <i>Size [AWG]</i>	Diametro <i>Diameter [mm]</i>	Tensione <i>Voltage [V]</i>	Portata ⁽¹⁾ <i>Current ⁽¹⁾ [A]</i>	Colorazione dei conduttori <i>Conductors' colors</i>
CV02XW18_80010_NE	S	2	18	8,9	600	10	Nero, bianco <i>Black, white</i>
CV02XW16_80010_NE	S	2	16	9,4	600	13	Nero, bianco <i>Black, white</i>
CV02XW14_80010_NE	S	2	14	13	600	18	Nero, bianco <i>Black, white</i>
CV02XW12_80010_NE	S	2	12	15	600	25	Nero, bianco <i>Black, white</i>
CV02XW10_80010_NE	S	2	10	16,3	600	30	Nero, bianco <i>Black, white</i>
CV03XW18_80010_NE	S	3	18	9,4	600	10	Nero, bianco, verde <i>Black, white, green</i>
CV03XW16_80010_NE	S	3	16	9,9	600	13	Nero, bianco, verde <i>Black, white, green</i>
CV03XW14_80010_NE	S	3	14	13,7	600	18	Nero, bianco, verde <i>Black, white, green</i>

(1) Valori basati su una temperatura ambiente di 30°C considerando che un conduttore sia di terra (oltre i 3 conduttori). Fare riferimento all'Art. 400 del NFPA 70(NEC) per maggiori dettagli.

(1) Values based on an ambient temperature of 30°C, considering that a conductor is grounded (over 3 conductors). Refer to Art. 400 of NFPA 70 (NEC) for more details.

Cavi "Made in USA" - "Made in USA" cables

Codice Code	Type	Numero di conduttori Number of conductors	Sezione Size [AWG]	Diametro Diameter [mm]	Tensione Voltage [V]	Portata ⁽¹⁾ Current ⁽¹⁾ [A]	Colorazione dei conduttori Conductors' colors
CV03XW12_80010_NE	S	3	12	15,7	600	25	Nero, bianco, verde Black, white, green
CV03XW10_80010_NE	S	3	10	17	600	30	Nero, bianco, verde Black, white, green
CV04XW18_80010_NE	S	4	18	10,2	600	7	Nero, bianco, rosso, verde Black, white, red, green
CV04XW16_80010_NE	S	4	16	10,9	600	10	Nero, bianco, rosso, verde Black, white, red, green
CV04XW14_80010_NE	S	4	14	14,7	600	15	Nero, bianco, rosso, verde Black, white, red, green
CV04XW12_80010_NE	S	4	12	17	600	20	Nero, bianco, rosso, verde Black, white, red, green
CV04XW10_80010_NE	S	4	10	18,5	600	25	Nero, bianco, rosso, verde Black, white, red, green
CV02XW18_80020_NE	SJ	2	18	7,4	300	10	Nero, bianco Black, white
CV02XW16_80020_NE	SJ	2	16	8	300	13	Nero, bianco Black, white
CV02XW14_80020_NE	SJ	2	14	8,6	300	18	Nero, bianco Black, white
CV02XW12_80020_NE	SJ	2	12	10,4	300	25	Nero, bianco Black, white
CV02XW10_80020_NE	SJ	2	10	14	300	30	Nero, bianco Black, white
CV03XW18_80020_NE	SJ	3	18	7,9	300	10	Nero, bianco, verde Black, white, green
CV03XW16_80020_NE	SJ	3	16	8,4	300	13	Nero, bianco, verde Black, white, green
CV03XW14_80020_NE	SJ	3	14	9,3	300	18	Nero, bianco, verde Black, white, green
CV03XW12_80020_NE	SJ	3	12	10,9	300	25	Nero, bianco, verde Black, white, green
CV03XW10_80020_NE	SJ	3	10	15	300	30	Nero, bianco, verde Black, white, green
CV04XW18_80020_NE	SJ	4	18	8,1	300	7	Nero, bianco, rosso, verde Black, white, red, green
CV04XW16_80020_NE	SJ	4	16	9,3	300	10	Nero, bianco, rosso, verde Black, white, red, green
CV04XW14_80020_NE	SJ	4	14	10	300	15	Nero, bianco, rosso, verde Black, white, red, green
CV04XW12_80020_NE	SJ	4	12	11,9	300	20	Nero, bianco, rosso, verde Black, white, red, green
CV04XW10_80020_NE	SJ	4	10	16,6	300	25	Nero, bianco, rosso, verde Black, white, red, green

(1) Valori basati su una temperatura ambiente di 30°C considerando che un conduttore sia di terra (oltre i 3 conduttori). Fare riferimento all'Art. 400 del NFPA 70(NEC) per maggiori dettagli.

(1) Values based on an ambient temperature of 30°C, considering that a conductor is grounded (over 3 conductors). Refer to Art. 400 of NFPA 70 (NEC) for more details.

SERIES
80140
80160

Flexible cord type SJOOW



“UL-CSA Listed”



Impiego - Use

Cavi flessibili UL Listed costruiti per gli usi specificati dall'articolo 400 del ANSI/NFPA 70 "National Electrical Code" (NEC). I cavi type SJOOW sono utilizzati per utensili ed attrezzature portatili o piccoli motori. Versione standard (Serie 80140) con temperatura di isolamento a 90°C, su richiesta è possibile produrre con temperatura di isolamento a 105°C (Serie 80160).

UL Listed flexible cables built for the uses specified by Art. 400 of ANSI/NFPA 70 "National Electrical Code" (NEC). The SJOOW type cables are used for portable tools and equipment or for small engines. Standard version (Series 80140) with insulation temperature of 90°C, on request it is possible to produce with insulation temperature of 105°C (Series 80160).

Informazione. Si prega di chiedere all'ufficio commerciale la possibilità del servizio aggiuntivo di taglio a misura certificato UL ("Processed Wire").

Information. Please ask the sales department for the possibility of an additional UL certified cut-to-size service ("Processed Wire").

Marcatura - Marking

TEKIMA 80140 – c(UL)us Type SJOOW E514001 4/C 16 AWG (1.31 mm²) 90°C
SUN & WATER RES 300 V FT2 -40°C = (metric) = (prod.reference)

TEKIMA 80160 – c(UL)us Type SJOOW E514001 4/C 16 AWG (1.31 mm²) 105°C
SUN & WATER RES 300 V FT2 -50°C = (metric) = (prod.reference)

Dati tecnici - Technical data

Caratteristica - Characteristics	Valore/proprietà - Value/property
Identificazione <i>Identification</i>	Junior hard service cord
Tipologia <i>Type</i>	SJOOW
Isolamento <i>Insulation</i>	Termoindurente <i>Thermoset</i>
Numero di conduttori <i>Number of conductor</i>	2÷4
Sezione <i>Size</i>	18÷10 AWG
Guaina <i>Jacket</i>	Termoindurente oil resistant, colore nero <i>Thermoset oil-resistant, black color</i>
Tensione <i>Voltage</i>	300V
Temperatura di esercizio <i>Temperature range</i>	-40°C; +90°C (Series 80140) -50°C; +105°C (Series 80160*)
Utilizzo <i>Use</i>	Pendant or portable. Damp and wet locations. Hard usage.
Riferimenti normativi costruttivi <i>Standards of construction</i>	UL/CSA Approvals: NEC Art. 400; CSA C22.1 (CE Code); C22.2 No. 49; UL 62
Riferimenti normativi d'impiego <i>Standards of use</i>	NFPA 70 (NEC) Art. 400; CSA C22.1 (CE Code)

Per assicurare la corretta destinazione d'uso definita nel NEC si è deciso di mantenere la versione linguistica originaria.

* Solo su specifica richiesta e per quantitativo minimo applicabile.

* Available upon request and with minimum applicable quantities.

Codifiche e dimensioni - Coding and dimensions

Codice <i>Code</i>	Type	Numero di conduttori <i>Number of conductors</i>	Sezione <i>Size [AWG]</i>	Diametro <i>Diameter [mm]</i>	Tensione <i>Voltage [V]</i>	Portata ⁽¹⁾ <i>Current ⁽¹⁾ [A]</i>	Colorazione dei conduttori <i>Conductors' colors</i>
CV02XW18_80140_NE	SJOOW	2	18	7,4	300	10	Nero, bianco <i>Black, white</i>
CV02XW16_80140_NE	SJOOW	2	16	7,9	300	13	Nero, bianco <i>Black, white</i>
CV02XW14_80140_NE	SJOOW	2	14	8,7	300	18	Nero, bianco <i>Black, white</i>
CV02XW12_80140_NE	SJOOW	2	12	10,4	300	25	Nero, bianco <i>Black, white</i>
CV03XW18_80140_NE	SJOOW	3	18	7,9	300	10	Nero, bianco, verde <i>Black, white, green</i>
CV03XW16_80140_NE	SJOOW	3	16	8,4	300	13	Nero, bianco, verde <i>Black, white, green</i>
CV03XW14_80140_NE	SJOOW	3	14	9,3	300	18	Nero, bianco, verde <i>Black, white, green</i>
CV03XW12_80140_NE	SJOOW	3	12	10,9	300	25	Nero, bianco, verde <i>Black, white, green</i>
CV03XW10_80140_NE	SJOOW	3	10	15,5	300	30	Nero, bianco, verde <i>Black, white, green</i>
CV04XW18_80140_NE	SJOOW	4	18	8,6	300	7	Nero, bianco, rosso, verde <i>Black, white, red, green</i>
CV04XW16_80140_NE	SJOOW	4	16	9,4	300	10	Nero, bianco, rosso, verde <i>Black, white, red, green</i>
CV04XW14_80140_NE	SJOOW	4	14	10,5	300	15	Nero, bianco, rosso, verde <i>Black, white, red, green</i>
CV04XW12_80140_NE	SJOOW	4	12	12,1	300	20	Nero, bianco, rosso, verde <i>Black, white, red, green</i>
CV04XW10_80140_NE	SJOOW	4	10	16,9	300	25	Nero, bianco, rosso, verde <i>Black, white, red, green</i>

(1) Valori basati su una temperatura ambiente di 30°C considerando che un conduttore sia di terra (oltre i 3 conduttori). Fare riferimento all'Art. 400 del NFPA 70(NEC) per maggiori dettagli.

(1) Values based on an ambient temperature of 30°C, considering that a conductor is grounded (over 3 conductors). Refer to Art. 400 of NFPA 70 (NEC) for more details.

**SERIES
80080**

Flexible cord type STOW



"UL-CSA Listed"

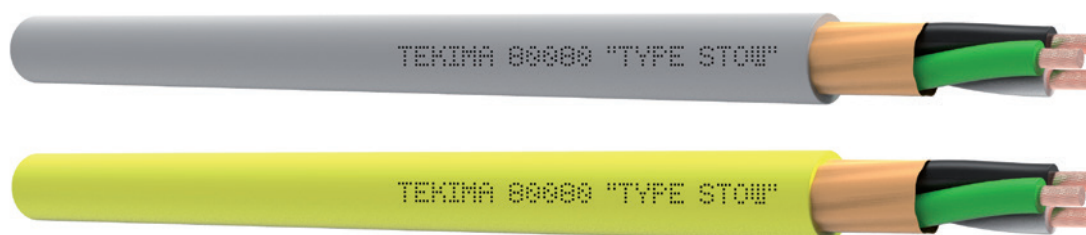

Impiego - Use

Cavi flessibili UL Listed costruiti per gli usi specificati dall'articolo 400 del ANSI/NFPA 70 "National Electrical Code" (NEC). I cavi type STOW sono utilizzati per utensili portatili, motori, attrezzature per la manutenzione dei pavimenti, attrezzature ospedaliere, macchine lavatrici, lampade o apparecchi simili. Possono essere utilizzati in zone a pericolo di esplosione Class I/II secondo quanto specificato dagli Art. 501.140 e 502.140 seguendo le metodologie di cablaggio definite rispettivamente negli Art. 501.10 e 502.10.

UL Listed flexible cables built for the uses specified by Art. 400 of ANSI/NFPA 70 "National Electrical Code" (NEC). STOW type cables are used for portable tools, engines, equipment for floor maintenance, hospital equipment, washing machines, lamps or similar devices. They can be used in Class I/II hazardous locations according to the specifications of Art. 501.140 and 502.140

Dati tecnici - Technical data

Caratteristica - Characteristics	Valore/proprietà - Value/property
Identificazione <i>Identification</i>	Hard service cord
Tipologia <i>Type</i>	STOW
Isolamento <i>Insulation</i>	PVC
Numero di conduttori <i>Number of conductor</i>	2÷4
Sezione <i>Size</i>	18÷12 AWG
Guaina <i>Jacket</i>	PVC resistente ad oli e acqua, colore grigio o giallo <i>PVC Oil- and water-resistant, gray or yellow color</i>
Tensione <i>Voltage</i>	600V
Temperatura di esercizio <i>Temperature range</i>	-40°C; +90°C
Utilizzo <i>Use</i>	Pendant or portable. Damp and wet locations. Extra hard usage.
Riferimenti normativi costruttivi <i>Standards of construction</i>	UL/CSA Approvals: Class 1, Div. 1 & Div. 2 NEC Art. 400, 501, 502; CSA C22.1 (CE Code); C22.2 No. 49; UL 62
Riferimenti normativi d'impiego <i>Standards of use</i>	NFPA 70 (NEC) Art. 400, 501, 502; CSA C22.1 (CE Code)

Per assicurare la corretta destinazione d'uso definita nel NEC si è deciso di mantenere la versione linguistica originaria.

Codifiche e dimensioni - Coding and dimensions

Codice <i>Code</i>	Type	Numero di conduttori <i>Number of conductors</i>	Sezione Size [AWG]	Diametro Diameter [mm]	Tensione Voltage [V]	Portata ⁽¹⁾ Current ⁽¹⁾ [A]	Colorazione dei conduttori <i>Conductors' colors</i>	Colore guaina esterna <i>External jacket Color</i>
CV02XW18_80080_GI	STOW	2	18	8,8	600	10	Nero, bianco <i>Black, white</i>	Giallo <i>Yellow</i>
CV02XW18_80080_GR	STOW	2	18	8,8	600	10	Nero, bianco <i>Black, white</i>	Grigio <i>Gray</i>
CV02XW16_80080_GI	STOW	2	16	9,4	600	13	Nero, bianco <i>Black, white</i>	Giallo <i>Yellow</i>
CV02XW16_80080_GR	STOW	2	16	9,4	600	13	Nero, bianco <i>Black, white</i>	Grigio <i>Gray</i>
CV02XW14_80080_GI	STOW	2	14	12,7	600	18	Nero, bianco <i>Black, white</i>	Giallo <i>Yellow</i>
CV02XW14_80080_GR	STOW	2	14	12,7	600	18	Nero, bianco <i>Black, white</i>	Grigio <i>Gray</i>
CV02XW12_80080_GI	STOW	2	12	14,6	600	25	Nero, bianco <i>Black, white</i>	Giallo <i>Yellow</i>
CV02XW12_80080_GR	STOW	2	12	14,6	600	25	Nero, bianco <i>Black, white</i>	Grigio <i>Gray</i>
CV03XW18_80080_GI	STOW	3	18	9,2	600	10	Nero, bianco, verde <i>Black, white, green</i>	Giallo <i>Yellow</i>

(1) Valori basati su una temperatura ambiente di 30°C considerando che un conduttore sia di terra (oltre i 3 conduttori). Fare riferimento all'Art. 400 del NFPA 70(NEC) per maggiori dettagli.

(1) Values based on an ambient temperature of 30°C, considering that a conductor is grounded (over 3 conductors). Refer to Art. 400 of NFPA 70 (NEC) for more details.

Codice Code	Type	Numero di conduttori Number of conductors	Sezione Size [AWG]	Diametro Diameter [mm]	Tensione Voltage [V]	Portata ⁽¹⁾ Current ⁽¹⁾ [A]	Colorazione dei conduttori Conductors' colors	Colore guaina esterna External jacket Color
CV03XW18_80080_GR	STOW	3	18	9,2	600	10	Nero, bianco, verde Black, white, green	Grigio Gray
CV03XW16_80080_GI	STOW	3	16	9,8	600	13	Nero, bianco, verde Black, white, green	Giallo Yellow
CV03XW16_80080_GR	STOW	3	16	9,8	600	13	Nero, bianco, verde Black, white, green	Grigio Gray
CV03XW14_80080_GI	STOW	3	14	13,4	600	18	Nero, bianco, verde Black, white, green	Giallo Yellow
CV03XW14_80080_GR	STOW	3	14	13,4	600	18	Nero, bianco, verde Black, white, green	Grigio Gray
CV03XW12_80080_GI	STOW	3	12	15,3	600	25	Nero, bianco, verde Black, white, green	Giallo Yellow
CV03XW12_80080_GR	STOW	3	12	15,3	600	25	Nero, bianco, verde Black, white, green	Grigio Gray
CV04XW18_80080_GI	STOW	4	18	9,9	600	7	Nero, bianco, rosso, verde Black, white, red, green	Giallo Yellow
CV04XW18_80080_GR	STOW	4	18	9,9	600	7	Nero, bianco, rosso, verde Black, white, red, green	Grigio Gray
CV04XW16_80080_GI	STOW	4	16	10,6	600	10	Nero, bianco, rosso, verde Black, white, red, green	Giallo Yellow
CV04XW16_80080_GR	STOW	4	16	10,6	600	10	Nero, bianco, rosso, verde Black, white, red, green	Grigio Gray
CV04XW14_80080_GI	STOW	4	14	14,5	600	15	Nero, bianco, rosso, verde Black, white, red, green	Giallo Yellow
CV04XW14_80080_GR	STOW	4	14	14,5	600	15	Nero, bianco, rosso, verde Black, white, red, green	Grigio Gray
CV04XW12_80080_GI	STOW	4	12	16,5	600	20	Nero, bianco, rosso, verde Black, white, red, green	Giallo Yellow
CV04XW12_80080_GR	STOW	4	12	16,5	600	20	Nero, bianco, rosso, verde Black, white, red, green	Grigio Gray

(1) Valori basati su una temperatura ambiente di 30°C considerando che un conduttore sia di terra (oltre i 3 conduttori). Fare riferimento all'Art. 400 del NFPA 70(NEC) per maggiori dettagli.

(1) Values based on an ambient temperature of 30°C, considering that a conductor is grounded (over 3 conductors). Refer to Art. 400 of NFPA 70 (NEC) for more details.

**SERIES
80060**

Flexible cord type SJTOW



"UL-CSA Listed"



Impiego - Use

Cavi flessibili UL Listed costruiti per gli usi specificati dall'articolo 400 del ANSI/NFPA 70 "National Electrical Code" (NEC). I cavi type SJTOW sono utilizzati per utensili portatili, motori, attrezzature per la manutenzione dei pavimenti, attrezzature ospedaliere, macchine lavatrici, lampade o apparecchi similari.

UL Listed flexible cables built for the uses specified by Art. 400 of ANSI/NFPA 70 "National Electrical Code" (NEC). The SJTOW type cables are used for portable tools, engines, equipment for floor maintenance, hospital equipment, washing machines, lamps or similar devices.

Informazione. Si prega di chiedere all'ufficio commerciale la possibilità del servizio aggiuntivo di taglio a misura certificato UL ("Processed Wire").
Information. Please ask the sales department for the possibility of an additional UL certified cut-to-size service ("Processed Wire").

Dati tecnici - Technical data

Caratteristica - Characteristics	Valore/proprietà - Value/property
Identificazione <i>Identification</i>	Junior hard service cord
Tipologia <i>Type</i>	SJTOW
Isolamento <i>Insulation</i>	PVC
Numero di conduttori <i>Number of conductor</i>	2÷4
Sezione AWG <i>Size</i>	18÷12
Guaina <i>Jacket</i>	PVC resistente ad oli e acqua, colore grigio o giallo <i>PVC Oil- and water-resistant, gray or yellow color</i>
Tensione <i>Voltage</i>	300 V
Temperatura di esercizio <i>Temperature range</i>	-40°C; +90°C
Utilizzo <i>Use</i>	Pendant or portable. Damp locations. Hard usage.
Riferimenti normativi costruttivi <i>Standards of construction</i>	UL/CSA Approvals: NEC Art. 400; CSA C22.1 (CE Code); C22.2 No. 49; UL 62
Riferimenti normativi d'impiego <i>Standards of use</i>	NFPA 70 (NEC) Art. 400; CSA C22.1 (CE Code)

Per assicurare la corretta destinazione d'uso definita nel NEC si è deciso di mantenere la versione linguistica originaria.

Codifiche e dimensioni - Coding and dimensions

Codice <i>Code</i>	Type	Numero di conduttori <i>Number of conductors</i>	Sezione Size [AWG]	Diametro Diameter [mm]	Tensione Voltage [V]	Portata ⁽¹⁾ Current ⁽¹⁾ [A]	Colorazione dei conduttori <i>Conductors' colors</i>	Colore guaina esterna <i>Outer jacket color</i>
CV02XW18_80060_GI	SJTOW	2	18	7,2	300	10	Nero, bianco <i>Black, white</i>	Giallo <i>Yellow</i>
CV02XW18_80060_GR	SJTOW	2	18	7,2	300	10	Nero, bianco <i>Black, white</i>	Grigio <i>Gray</i>
CV02XW16_80060_GI	SJTOW	2	16	7,8	300	13	Nero, bianco <i>Black, white</i>	Giallo <i>Yellow</i>
CV02XW16_80060_GR	SJTOW	2	16	7,8	300	13	Nero, bianco <i>Black, white</i>	Grigio <i>Gray</i>
CV02XW14_80060_GI	SJTOW	2	14	8,7	300	18	Nero, bianco <i>Black, white</i>	Giallo <i>Yellow</i>
CV02XW14_80060_GR	SJTOW	2	14	8,7	300	18	Nero, bianco <i>Black, white</i>	Grigio <i>Gray</i>
CV02XW12_80060_GI	SJTOW	2	12	10,4	300	25	Nero, bianco <i>Black, white</i>	Giallo <i>Yellow</i>
CV02XW12_80060_GR	SJTOW	2	12	10,4	300	25	Nero, bianco <i>Black, white</i>	Grigio <i>Gray</i>
CV03XW18_80060_GI	SJTOW	3	18	7,6	300	10	Nero, bianco, verde <i>Black, white, green</i>	Giallo <i>Yellow</i>

(1) Valori basati su una temperatura ambiente di 30°C, fare riferimento all'Art. 400 del NFPA 70(NEC) per maggiori dettagli.

(1) Values based on an ambient temperature of 30°C, refer to Art. 400 of NFPA 70 (NEC) for more details.

Codice Code	Type	Numero di conduttori Number of conductors	Sezione Size [AWG]	Diametro Diameter [mm]	Tensione Voltage [V]	Portata ⁽¹⁾ Current ⁽¹⁾ [A]	Colorazione dei conduttori Conductors' colors	Colore guaina esterna Outer jacket color
CV03XW18_80060_GR	SJTOW	3	18	7,6	300	10	Nero, bianco, verde Black, white, green	Grigio Gray
CV03XW16_80060_GI	SJTOW	3	16	8,3	300	13	Nero, bianco, verde Black, white, green	Giallo Yellow
CV03XW16_80060_GR	SJTOW	3	16	8,3	300	13	Nero, bianco, verde Black, white, green	Grigio Gray
CV03XW14_80060_GI	SJTOW	3	14	9,2	300	18	Nero, bianco, verde Black, white, green	Giallo Yellow
CV03XW14_80060_GR	SJTOW	3	14	9,2	300	18	Nero, bianco, verde Black, white, green	Grigio Gray
CV03XW12_80060_GI	SJTOW	3	12	11	300	25	Nero, bianco, verde Black, white, green	Giallo Yellow
CV03XW12_80060_GR	SJTOW	3	12	11	300	25	Nero, bianco, verde Black, white, green	Grigio Gray
CV04XW18_80060_GI	SJTOW	4	18	8,4	300	7	Nero, bianco, rosso, verde Black, white, red, green	Giallo Yellow
CV04XW18_80060_GR	SJTOW	4	18	8,4	300	7	Nero, bianco, rosso, verde Black, white, red, green	Grigio Gray
CV04XW16_80060_GI	SJTOW	4	16	9,1	300	10	Nero, bianco, rosso, verde Black, white, red, green	Giallo Yellow
CV04XW16_80060_GR	SJTOW	4	16	9,1	300	10	Nero, bianco, rosso, verde Black, white, red, green	Grigio Gray
CV04XW14_80060_GI	SJTOW	4	14	10,1	300	15	Nero, bianco, rosso, verde Black, white, red, green	Giallo Yellow
CV04XW14_80060_GR	SJTOW	4	14	10,1	300	15	Nero, bianco, rosso, verde Black, white, red, green	Grigio Gray
CV04XW12_80060_GI	SJTOW	4	12	12,1	300	20	Nero, bianco, rosso, verde Black, white, red, green	Giallo Yellow
CV04XW12_80060_GR	SJTOW	4	12	12,1	300	20	Nero, bianco, rosso, verde Black, white, red, green	Grigio Gray

(1) Valori basati su una temperatura ambiente di 30°C, fare riferimento all'Art. 400 del NFPA 70 (NEC) per maggiori dettagli.

(1) Values based on an ambient temperature of 30°C, refer to Art. 400 of NFPA 70 (NEC) for more details.

SERIES
80050

Flexible cord type SJT



"UL-CSA Listed"



Impiego - Use

Cavi flessibili UL Listed costruiti per gli usi specificati dall'articolo 400 del ANSI/NFPA 70 "National Electrical Code" (NEC). I cavi type SJT sono utilizzati per utensili portatili, motori, apparecchi di illuminazione portatili, lampade.

UL Listed flexible cables built for the uses specified by Art. 400 of ANSI/NFPA 70 "National Electrical Code" (NEC). SJT type cables are used for portable tools, engines, portable lighting devices, lamps.

Informazione. Si prega di chiedere all'ufficio commerciale la possibilità del servizio aggiuntivo di taglio a misura certificato UL ("Processed Wire").

Information. Please ask the sales department for the possibility of an additional UL certified cut-to-size service ("Processed Wire").

Dati tecnici - Technical data

Caratteristica - Characteristics	Valore/proprietà - Value/property
Identificazione <i>Identification</i>	Junior hard service cord
Tipologia <i>Type</i>	SJT
Isolamento <i>Insulation</i>	PVC
Numero di conduttori <i>Number of conductor</i>	2÷4
Sezione AWG <i>Size AWG</i>	18÷16
Guaina <i>Jacket</i>	PVC, colore nero <i>PVC, black color</i>
Tensione <i>Voltage</i>	300 V
Temperatura di esercizio <i>Temperature range</i>	-20°C; +60°C
Utilizzo <i>Use</i>	Pendant or portable. Damp locations. Hard usage.
Riferimenti normativi costruttivi <i>Standards of construction</i>	UL/CSA Approvals: NEC Art. 400; CSA C22.1 (CE Code); C22.2 No. 49; UL 62
Riferimenti normativi d'impiego <i>Standards of use</i>	NFPA 70 (NEC) Art. 400; CSA C22.1 (CE Code)

Per assicurare la corretta destinazione d'uso definita nel NEC si è deciso di mantenere la versione linguistica originaria.

Codifiche e dimensioni - Coding and dimensions

Codice <i>Code</i>	Type	Numero di conduttori <i>Number of conductors</i>	Sezione Size [AWG]	Diametro Diameter [mm]	Tensione Voltage [V]	Portata ⁽¹⁾ Current ⁽¹⁾ [A]	Colorazione dei conduttori <i>Conductors' colors</i>	Colore guaina esterna <i>Outer jacket color</i>
CV02XW18_80050_NE	SJT	2	18	7,2	300	10	Nero-bianco <i>Black-white</i>	Nero <i>Black</i>
CV02XW16_80050_NE	SJT	2	16	7,8	300	13	Nero-bianco <i>Black-white</i>	Nero <i>Black</i>
CV03XW18_80050_NE	SJT	3	18	7,6	300	10	Nero-bianco-verde <i>Black-white-green</i>	Nero <i>Black</i>
CV04XW18_80050_NE	SJT	4	18	8,4	300	7	Nero-bianco-rosso-verde <i>Black-white-red-green</i>	Nero <i>Black</i>
CV04XW16_80050_NE	SJT	4	16	9,1	300	10	Nero-bianco-rosso-verde <i>Black-white-red-green</i>	Nero <i>Black</i>

(1) Valori basati su una temperatura ambiente di 30°C considerando che un conduttore sia di terra (oltre i 3 conduttori). Fare riferimento all'Art. 400 del NFPA 70 (NEC) per maggiori dettagli.

(1) Values based on an ambient temperature of 30°C, considering that a conductor is grounded (over 3 conductors). Refer to Art. 400 of NFPA 70 (NEC) for more details.

SERIES
80120
8012S

Flexible cord type SOOW



“UL-CSA Listed”



Impiego - Use

Cavi flessibili UL Listed costruiti per gli usi specificati dall'articolo 400 del ANSI/NFPA 70 “National Electrical Code” (NEC). I cavi type SOOW sono utilizzati per applicazioni di controllo industriale e di utilità, circuiti di segnale e altri usi di controllo generale in impianti industriali, acciaierie, impianti di processo e cantieri. Possono essere utilizzati in zone a pericolo di esplosione Class I/II secondo quanto specificato dagli Art. 501.140 e 502.140 seguendo le metodologie di cablaggio definite rispettivamente negli Art. 501.10 e 502.10.

UL Listed flexible cables built for the uses specified by Art. 400 of ANSI/NFPA 70 “National Electrical Code” (NEC). The SOOW type cables are used in industrial and utility control applications, signal circuits, and other general control uses in industrial plants, steel mills, process facilities and construction sites. They can be used in Class I/II hazardous locations according to the specifications of Art. 501.140 and 502.140 following the harness methods specified by Art. 501.10 and 502.10.

Informazione. Si prega di chiedere all'ufficio commerciale la possibilità del servizio aggiuntivo di taglio a misura certificato UL (“Processed Wire”).
Information. Please ask the sales department for the possibility of an additional UL certified cut-to-size service (“Processed Wire”).

Marcatura - Marking

TEKIMA 80120 – c(UL)us Type SOOW E514001 4/C 16 AWG (1.31 mm²) 90°C
SUN & WATER RES 600 V FT2 -40°C = (metric) = (prod.reference)

Dati tecnici - Technical data

Caratteristica - Characteristics	Valore/proprietà - Value/property
Identificazione <i>Identification</i>	Hard service cord
Tipologia <i>Type</i>	SOOW
Isolamento <i>Insulation</i>	Termoindurente <i>Thermoset</i>
Numero di conduttori <i>Number of conductor</i>	2 o più <i>2 or more</i>
Sezione AWG <i>Size AWG</i>	18÷2
Guaina <i>Jacket</i>	Termoindurente oil resistant, colore nero <i>Thermoset oil-resistant, black color</i>
Tensione <i>Voltage</i>	600V
Temperatura di esercizio <i>Temperature range</i>	-40°C + 90°C
Utilizzo <i>Use</i>	Pendant or portable, damp and wet location, extra hard usage
Riferimenti normativi costruttivi <i>Standards of construction</i>	UL/CSA Approvals: Class 1, Div. 1 & Div. 2 NEC Art. 400, 501, 502; CSA C22.1 (CE Code); C22.2 No. 49; UL 62
Riferimenti normativi d'impiego <i>Standards of use</i>	NFPA 70 (NEC) Art. 400, 501, 502; CSA C22.1 (CE Code)

Per assicurare la corretta destinazione d'uso definita nel NEC si è deciso di mantenere la versione linguistica originaria.

Codifiche e dimensioni - Coding and dimensions

Codice <i>Code</i>	Type	Schermato <i>Shielded</i>	Numero di conduttori <i>Number of conductors</i>	Sezione <i>Size [AWG]</i>	Diametro <i>Diameter [mm]</i>	Tensione <i>Voltage [V]</i>	Portata ⁽¹⁾ <i>Current ⁽¹⁾ [A]</i>	Colorazione dei conduttori <i>Conductors' colors</i>
CV02XW18_80120_NE	SOOW	NO	2	18	8,8	600	10	Nero-bianco <i>Black-white</i>
CV02XW16_80120_NE	SOOW	NO	2	16	9,5	600	13	Nero-bianco <i>Black-white</i>
CV02XW14_80120_NE	SOOW	NO	2	14	12,7	600	18	Nero-bianco <i>Black-white</i>
CV02XW12_80120_NE	SOOW	NO	2	12	14,6	600	25	Nero-bianco <i>Black-white</i>
CV02XW10_80120_NE	SOOW	NO	2	10	15,9	600	30	Nero-bianco <i>Black-white</i>
CV02XW08_80120_NE	SOOW	NO	2	8	19,8	600	40	Nero-bianco <i>Black-white</i>
CV02XW06_80120_NE	SOOW	NO	2	6	23,4	600	55	Nero-bianco <i>Black-white</i>
CV02XW04_80120_NE	SOOW	NO	2	4	26,9	600	70	Nero-bianco <i>Black-white</i>
CV02XW02_80120_NE	SOOW	NO	2	2	30,7	600	95	Nero-bianco <i>Black-white</i>
CV03XW18_80120_NE	SOOW	NO	3	18	9,3	600	10	Nero-bianco-verde <i>Black-white-green</i>

(1) Valori basati su una temperatura ambiente di 30°C considerando che un conduttore sia di terra (oltre i 3 conduttori). Fare riferimento all'Art. 400 del NFPA 70(NEC) per maggiori dettagli.

(1) Values based on an ambient temperature of 30°C, considering that a conductor is grounded (over 3 conductors). Refer to Art. 400 of NFPA 70 (NEC) for more details.

Cavi "Made in USA" - "Made in USA" cables

Codice Code	Type	Schermato Shielded	Numero di conduttori Number of conductors	Sezione Size [AWG]	Diametro Diameter [mm]	Tensione Voltage [V]	Portata ⁽¹⁾ Current [A]	Colorazione dei conduttori Conductors' colors
CV03XW16_80120_NE	S00W	NO	3	16	10,1	600	13	Nero-bianco-verde Black-white-green
CV03XW14_80120_NE	S00W	NO	3	14	13,5	600	18	Nero-bianco-verde Black-white-green
CV03XW12_80120_NE	S00W	NO	3	12	15,2	600	25	Nero-bianco-verde Black-white-green
CV03XW10_80120_NE	S00W	NO	3	10	16,8	600	30	Nero-bianco-verde Black-white-green
CV03XW08_80120_NE	S00W	NO	3	8	21,1	600	40	Nero-bianco-verde Black-white-green
CV03XW06_80120_NE	S00W	NO	3	6	24,6	600	55	Nero-bianco-verde Black-white-green
CV03XW04_80120_NE	S00W	NO	3	4	28,7	600	70	Nero-bianco-verde Black-white-green
CV03XW02_80120_NE	S00W	NO	3	2	33,1	600	95	Nero-bianco-verde Black-white-green
CV04XW18_80120_NE	S00W	NO	4	18	9,9	600	7	Nero-bianco-verde-rosso Black-white-green-red
CV04XW16_80120_NE	S00W	NO	4	16	10,8	600	10	Nero-bianco-verde-rosso Black-white-green-red
CV04XW14_80120_NE	S00W	NO	4	14	14,5	600	15	Nero-bianco-verde-rosso Black-white-green-red
CV04XW12_80120_NE	S00W	NO	4	12	16,5	600	20	Nero-bianco-verde-rosso Black-white-green-red
CV04XW10_80120_NE	S00W	NO	4	10	18	600	25	Nero-bianco-verde-rosso Black-white-green-red
CV04XW08_80120_NE	S00W	NO	4	8	23,5	600	35	Nero-bianco-verde-rosso Black-white-green-red
CV04XW06_80120_NE	S00W	NO	4	6	26,9	600	45	Nero-bianco-verde-rosso Black-white-green-red
CV04XW04_80120_NE	S00W	NO	4	4	31,8	600	60	Nero-bianco-verde-rosso Black-white-green-red
CV04XW02_80120_NE	S00W	NO	4	2	36,8	600	80	Nero-bianco-verde-rosso Black-white-green-red
CV05XW18_80120_NE	S00W	NO	5	18	11,8	600	5,6	Nero-bianco-verde-rosso-arancione Black-white-green-red-orange
CV05XW16_80120_NE	S00W	NO	5	16	12,6	600	8	Nero-bianco-verde-rosso-arancione Black-white-green-red-orange
CV05XW08_80120_NE	S00W	NO	5	8	25,4	600	28	Nero-bianco-verde-rosso-arancione Black-white-green-red-orange
CV05XW06_80120_NE	S00W	NO	5	6	30	600	36	Nero-bianco-verde-rosso-arancione Black-white-green-red-orange
CV05XW04_80120_NE	S00W	NO	5	4	33,2	600	48	Nero-bianco-verde-rosso-arancione Black-white-green-red-orange
CV05XW02_80120_NE	S00W	NO	5	2	38,8	600	64	Nero-bianco-verde-rosso-arancione Black-white-green-red-orange
CV06XW18_80120_NE	S00W	NO	6	18	12,6	600	5,6	Verificare in fase d'ordine To be verified upon order receipt
CV06XW16_80120_NE	S00W	NO	6	16	13,4	600	8	Verificare in fase d'ordine To be verified upon order receipt
CV07XW18_80120_NE	S00W	NO	7	18	12,7	600	5,6	Verificare in fase d'ordine To be verified upon order receipt
CV07XW16_80120_NE	S00W	NO	7	16	14	600	8	Verificare in fase d'ordine To be verified upon order receipt
CV08XW18_80120_NE	S00W	NO	8	18	13,5	600	4,9	Verificare in fase d'ordine To be verified upon order receipt
CV08XW16_80120_NE	S00W	NO	8	16	14,6	600	7	Verificare in fase d'ordine To be verified upon order receipt
CV09XW16_80120_NE	S00W	NO	9	16	16,1	600	7	Verificare in fase d'ordine To be verified upon order receipt
CV10XW18_80120_NE	S00W	NO	10	18	15,6	600	4,9	Verificare in fase d'ordine To be verified upon order receipt
CV10XW16_80120_NE	S00W	NO	10	16	17,2	600	7	Verificare in fase d'ordine To be verified upon order receipt

(1) Valori basati su una temperatura ambiente di 30°C considerando che un conduttore sia di terra (oltre i 3 conduttori). Fare riferimento all'Art. 400 del NFPA 70 (NEC) per maggiori dettagli.

(1) Values based on an ambient temperature of 30°C, considering that a conductor is grounded (over 3 conductors). Refer to Art. 400 of NFPA 70 (NEC) for more details.

Codice Code	Type	Schermato Shielded	Numero di conduttori Number of conductors	Sezione Size [AWG]	Diametro Diameter [mm]	Tensione Voltage [V]	Portata ⁽¹⁾ Current ⁽¹⁾ [A]	Colorazione dei conduttori Conductors' colors
CV12XW18_80120_NE	S00W	NO	12	18	16,9	600	3,5	Verificare in fase d'ordine To be verified upon order receipt
CV12XW16_80120_NE	S00W	NO	12	16	17,7	600	5	Verificare in fase d'ordine To be verified upon order receipt
CV14XW18_80120_NE	S00W	NO	14	18	17,7	600	3,5	Verificare in fase d'ordine To be verified upon order receipt
CV14XW16_80120_NE	S00W	NO	14	16	19,1	600	5	Verificare in fase d'ordine To be verified upon order receipt
CV16XW18_80120_NE	S00W	NO	16	18	17,9	600	3,5	Verificare in fase d'ordine To be verified upon order receipt
CV16XW16_80120_NE	S00W	NO	16	16	20,1	600	5	Verificare in fase d'ordine To be verified upon order receipt
CV18XW18_80120_NE	S00W	NO	18	18	19,3	600	3,5	Verificare in fase d'ordine To be verified upon order receipt
CV18XW16_80120_NE	S00W	NO	18	16	20,3	600	5	Verificare in fase d'ordine To be verified upon order receipt
CV20XW18_80120_NE	S00W	NO	20	18	20,2	600	3,5	Verificare in fase d'ordine To be verified upon order receipt
CV20XW16_80120_NE	S00W	NO	20	16	21,2	600	5	Verificare in fase d'ordine To be verified upon order receipt
CV24XW18_80120_NE	S00W	NO	24	18	22,9	600	3,2	Verificare in fase d'ordine To be verified upon order receipt
CV24XW16_80120_NE	S00W	NO	24	16	23,5	600	4,5	Verificare in fase d'ordine To be verified upon order receipt
CV27XW16_80120_NE	S00W	NO	27	16	23,9	600	4,5	Verificare in fase d'ordine To be verified upon order receipt
CV30XW18_80120_NE	S00W	NO	30	18	24,1	600	3,2	Verificare in fase d'ordine To be verified upon order receipt
CV30XW16_80120_NE	S00W	NO	30	16	26,7	600	4,5	Verificare in fase d'ordine To be verified upon order receipt
CV36XW18_80120_NE	S00W	NO	36	18	26,7	600	2,8	Verificare in fase d'ordine To be verified upon order receipt
CV36XW16_80120_NE	S00W	NO	36	16	28,6	600	4	Verificare in fase d'ordine To be verified upon order receipt
CV37XW16_80120_NE	S00W	NO	37	16	30,1	600	4	Verificare in fase d'ordine To be verified upon order receipt
CV44XW18_80120_NE	S00W	NO	44	18	29,7	600	2,5	Verificare in fase d'ordine To be verified upon order receipt
CV44XW16_80120_NE	S00W	NO	44	16	32,9	600	3,5	Verificare in fase d'ordine To be verified upon order receipt
CV52XW18_80120_NE	S00W	NO	52	18	30,9	600	2,5	Verificare in fase d'ordine To be verified upon order receipt
CV52XW16_80120_NE	S00W	NO	52	16	34,2	600	3,5	Verificare in fase d'ordine To be verified upon order receipt
CV60XW18_80120_NE	S00W	NO	60	18	33,4	600	2,5	Verificare in fase d'ordine To be verified upon order receipt
CV60XW16_80120_NE	S00W	NO	60	16	36,2	600	3,5	Verificare in fase d'ordine To be verified upon order receipt
CV04XW18_8012S_NE	S00W	SI YES	4	18	10,3	600	7	Nero-bianco-verde-rosso Black-white-green-red
CV05XW18_8012S_NE	S00W	SI YES	5	18	12,2	600	5,6	Nero-bianco-verde-rosso-arancione Black-white-green-red-orange
CV05XW16_8012S_NE	S00W	SI YES	5	16	13,5	600	8	Nero-bianco-verde-rosso-arancione Black-white-green-red-orange
CV07XW16_8012S_NE	S00W	SI YES	7	16	14,2	600	7	Verificare in fase d'ordine To be verified upon order receipt
CV08XW16_8012S_NE	S00W	SI YES	8	16	15,0	600	7	Verificare in fase d'ordine To be verified upon order receipt
CV12XW16_8012S_NE	S00W	SI YES	12	16	18,0	600	5	Verificare in fase d'ordine To be verified upon order receipt

(1) Valori basati su una temperatura ambiente di 30°C considerando che un conduttore sia di terra (oltre i 3 conduttori). Fare riferimento all'Art. 400 del NFPA 70(NEC) per maggiori dettagli.

(1) Values based on an ambient temperature of 30°C, considering that a conductor is grounded (over 3 conductors). Refer to Art. 400 of NFPA 70 (NEC) for more details.

SERIES
80130

Flexible cord type W



UL-CSA Listed*



Impiego - Use

Cavi flessibili UL Listed costruiti per gli usi specificati dall'articolo 400 del ANSI/NFPA 70 "National Electrical Code" (NEC). I cavi type W sono utilizzati su impianti quali gru, nastri trasportatori ed attrezzature mobili. Possono essere utilizzati in zone a pericolo di esplosione Class I/II secondo quanto specificato dagli Art. 501.140 e 502.140 seguendo le metodologie di cablaggio definite rispettivamente negli Art. 501.10 e 502.10.

UL Listed flexible cables built for uses specified by Art. 400 of ANSI/NFPA 70 "National Electrical Code" (NEC). The W type cables are used on systems such as cranes, conveyor belts and mobile equipment. They can be used in Class I/II hazardous locations according to the specifications of Art. 501.140 and 502.140 following the harness methods specified by Art. 501.10 and 502.10.

Informazione. Si prega di chiedere all'ufficio commerciale la possibilità del servizio aggiuntivo di taglio a misura certificato UL ("Processed Wire").

Information. Please ask the sales department for the possibility of an additional UL certified cut-to-size service ("Processed Wire").

Dati tecnici - Technical data

Caratteristica - Characteristics	Valore/proprietà - Value/property
Identificazione <i>Identification</i>	Portable power cable
Tipologia <i>Type</i>	W
Isolamento <i>Insulation</i>	Termodurente <i>Thermoset</i>
Numero di conduttori <i>Number of conductor</i>	1 ÷ 5
Sezione <i>Size</i>	8 AWG ÷ 500 kcmil
Guaina <i>Jacket</i>	Termodurente oil resistant, colore nero <i>Thermoset oil-resistant, black color</i>
Tensione <i>Voltage</i>	2000V
Temperatura di esercizio <i>Temperature range</i>	-40°C + 90°C
Utilizzo <i>Use</i>	Portable, extra hard usage
Riferimenti normativi costruttivi <i>Standards of construction</i>	UL/CSA Approvals: Class 1, Div. 1 & Div. 2 NEC Art. 400, 501, 502; CSA C22.1 (CE Code); C22.2 No. 96; UL 1650
Riferimenti normativi d'impiego <i>Standards of use</i>	NFPA 70 (NEC) Art. 400, 501, 502; CSA C22.1 (CE Code)

Per assicurare la corretta destinazione d'uso definite nel NEC si è deciso di mantenere la versione linguistica originaria.

Codifiche e dimensioni - Coding and dimensions

Codice <i>Code</i>	Type	Numero di conduttori <i>Number of conductors</i>	Sezione <i>Size [AWG/kcmil]</i>	Diametro <i>Diameter [mm]</i>	Tensione <i>Voltage [V]</i>	Portata ⁽¹⁾ <i>Current ⁽¹⁾ [A]</i>	Colorazione dei conduttori <i>Color of conductors</i>
CV01XW08_80130_NE	W	1	8 AWG	12,3	2000	80	Nero <i>Black</i>
CV01XW06_80130_NE	W	1	6	14,4	2000	105	Nero <i>Black</i>
CV01XW04_80130_NE	W	1	4	15,4	2000	140	Nero <i>Black</i>
CV01XW02_80130_NE	W	1	2	17,3	2000	190	Nero <i>Black</i>
CV01XW01_80130_NE	W	1	1	19,4	2000	220	Nero <i>Black</i>
CV01XW/1_80130_NE	W	1	1/0	20,6	2000	260	Nero <i>Black</i>
CV01XW/2_80130_NE	W	1	2/0	22,5	2000	300	Nero <i>Black</i>
CV01XW/3_80130_NE	W	1	3/0	23,6	2000	350	Nero <i>Black</i>
CV01XW/4_80130_NE	W	1	4/0	24,9	2000	405	Nero <i>Black</i>
CV01XX25_80130_NE	W	1	250 kcmil	26,5	2000	455	Nero <i>Black</i>

(1) Valori basati su una temperatura ambiente di 30°C considerando che un conduttore sia di terra (oltre i 3 conduttori). Fare riferimento all'Art. 400 del NFPA 70 (NEC) per maggiori dettagli.

(1) Values based on an ambient temperature of 30°C, considering that a conductor is grounded (over 3 conductors). Refer to Art. 400 of NFPA 70 (NEC) for more details.

Codice Code	Type	Numero di conduttori Number of conductors	Sezione Size [AWG/kcmil]	Diametro Diameter [mm]	Tensione Voltage [V]	Portata ⁽¹⁾ Current ⁽¹⁾ [A]	Colorazione dei conduttori Color of conductors
CV01XX35_80130_NE	W	1	350	29,1	2000	570	Nero Black
CVCWX50_80130_NE	W	1	500	33,3	2000	700	Nero Black
CV03XW08_80130_NE	W	3	8 AWG	23,1	2000	74	Nero, bianco, verde Black, white, green
CV03XW06_80130_NE	W	3	6	25,7	2000	99	Nero, bianco, verde Black, white, green
CV03XW04_80130_NE	W	3	4	29,7	2000	130	Nero, bianco, verde Black, white, green
CV03XW02_80130_NE	W	3	2	34	2000	174	Nero, bianco, verde Black, white, green
CV03XW01_80130_NE	W	3	1	38,4	2000	202	Nero, bianco, verde Black, white, green
CV03XW/1_80130_NE	W	3	1/0	41,9	2000	234	Nero, bianco, verde Black, white, green
CV03XW/2_80130_NE	W	3	2/0	44,5	2000	271	Nero, bianco, verde Black, white, green
CV03XW/3_80130_NE	W	3	3/0	48	2000	313	Nero, bianco, verde Black, white, green
CV03XW/4_80130_NE	W	3	4/0	51,8	2000	361	Nero, bianco, verde Black, white, green
CV03XX25_80130_NE	W	3	250 kcmil	60,7	2000	402	Nero, bianco, verde Black, white, green
CV03XX35_80130_NE	W	3	350	68,1	2000	495	Nero, bianco, verde Black, white, green
CV03XX50_80130_NE	W	3	500	77	2000	613	Nero, bianco, verde Black, white, green
CV04XW08_80130_NE	W	4	8 AWG	25,1	2000	65	Nero, bianco, rosso, verde Black, white, red, green
CV04XW06_80130_NE	W	4	6	27,9	2000	87	Nero, bianco, rosso, verde Black, white, red, green
CV04XW04_80130_NE	W	4	4	32,3	2000	114	Nero, bianco, rosso, verde Black, white, red, green
CV04XW02_80130_NE	W	4	2	37,6	2000	152	Nero, bianco, rosso, verde Black, white, red, green
CV04XW01_80130_NE	W	4	1	42,7	2000	177	Nero, bianco, rosso, verde Black, white, red, green
CV04XW/1_80130_NE	W	4	1/0	45,5	2000	205	Nero, bianco, rosso, verde Black, white, red, green
CV04XW/2_80130_NE	W	4	2/0	49	2000	237	Nero, bianco, rosso, verde Black, white, red, green
CV04XW/3_80130_NE	W	4	3/0	52,6	2000	274	Nero, bianco, rosso, verde Black, white, red, green
CV04XW/4_80130_NE	W	4	4/0	57,4	2000	316	Nero, bianco, rosso, verde Black, white, red, green
CV04XX25_80130_NE	W	4	250 kcmil	67,6	2000	352	Nero, bianco, rosso, verde Black, white, red, green
CV04XX35_80130_NE	W	4	350	75,7	2000	433	Nero, bianco, rosso, verde Black, white, red, green
CV04XX50_80130_NE	W	4	500	86,4	2000	536	Nero, bianco, rosso, verde Black, white, red, green
CV05XW08_80130_NE	W	5	8 AWG	24,3	2000	52	Nero, bianco, verde, rosso, arancione Black, white, red, green, orange
CV05XW06_80130_NE	W	5	6	27,2	2000	69	Nero, bianco, verde, rosso, arancione Black, white, red, green, orange
CV05XW04_80130_NE	W	5	4	31,4	2000	91	Nero, bianco, verde, rosso, arancione Black, white, red, green, orange
CV05XW02_80130_NE	W	5	2	35,7	2000	121	Nero, bianco, verde, rosso, arancione Black, white, red, green, orange
CV05XW/1_80130_NE	W	5	1/0	47,1	2000	164	Nero, bianco, verde, rosso, arancione Black, white, red, green, orange

(1) Valori basati su una temperatura ambiente di 30°C considerando che un conduttore sia di terra (oltre i 3 conduttori). Fare riferimento all'Art. 400 del NFPA 70 (NEC) per maggiori dettagli.

(1) Values based on an ambient temperature of 30°C, considering that a conductor is grounded (over 3 conductors). Refer to Art. 400 of NFPA 70 (NEC) for more details.

Codice <i>Code</i>	Type	Numero di conduttori <i>Number of conductors</i>	Sezione <i>Size [AWG/kcmil]</i>	Diametro <i>Diameter [mm]</i>	Tensione <i>Voltage [V]</i>	Portata ⁽¹⁾ <i>Current ⁽¹⁾ [A]</i>	Colorazione dei conduttori <i>Color of conductors</i>
CV05XW/2_80130_NE	W	5	2/0	50,2	2000	189	Nero, bianco, verde, rosso, arancione <i>Black, white, red, green, orange</i>
CV05XW/3_80130_NE	W	5	3/0	52,3	2000	219	Nero, bianco, verde, rosso, arancione <i>Black, white, red, green, orange</i>
CV05XW/4_80130_NE	W	5	4/0	57,6	2000	252	Nero, bianco, verde, rosso, arancione <i>Black, white, red, green, orange</i>

(1) Valori basati su una temperatura ambiente di 30°C considerando che un conduttore sia di terra (oltre i 3 conduttori). Fare riferimento all'Art. 400 del NFPA 70 (NEC) per maggiori dettagli.

(1) Values based on an ambient temperature of 30°C, considering that a conductor is grounded (over 3 conductors). Refer to Art. 400 of NFPA 70 (NEC) for more details.

SERIES
80150
80155

Flexible cord type G e G-GC



“UL-CSA Listed”



Impiego - Use

Cavi flessibili UL Listed costruiti per gli usi specificati dall'articolo 400 del ANSI/NFPA 70 "National Electrical Code" (NEC). I cavi type G e G-GC sono utilizzati su impianti quali gru, in applicazioni industriali leggere o medio leggere del settore minerario, attrezzature elettriche mobili e portatili. Possono essere utilizzati in zone a pericolo di esplosione Class I/II secondo quanto specificato dagli Art. 501.140 e 502.140 seguendo le metodologie di cablaggio definite rispettivamente negli Art. 501.10 e 502.10.

UL Listed flexible cables built for uses specified by Art. 400 of ANSI/NFPA 70 "National Electrical Code" (NEC). The G and G-GC type cables are used on equipment such as cranes, on light or average-light industrial applications of the mining sector, mobile and portable electrical equipment. They can be used in Class I/II hazardous locations according to the specifications of Art. 501.140 and 502.140, following the harness methods specified by Art. 501.10 and 502.10.

Informazione. Si prega di chiedere all'ufficio commerciale la possibilità del servizio aggiuntivo di taglio a misura certificato UL ("Processed Wire").

Information. Please ask the sales department for the possibility of an additional UL certified cut-to-size service ("Processed Wire").

Dati tecnici - Technical data

Caratteristica - Characteristics	Valore/proprietà - Value/property
Identificazione <i>Identification</i>	Portable power cable
Tipologia <i>Type</i>	G; G-GC
Isolamento <i>Insulation</i>	Termoindurente <i>Thermoset</i>
Numero di conduttori <i>Number of conductor</i>	3÷4 + conduttore di terra + eventuale ground check <i>3÷4 ground conductor + ground check</i>
Sezione <i>Size</i>	8 AWG÷500 kcmil
Guaina <i>Jacket</i>	Termoindurente oil resistant, colore nero <i>Thermoset oil-resistant, black color</i>
Tensione <i>Voltage</i>	2000V
Temperatura di esercizio <i>Temperature range</i>	-40°C + 90°C
Utilizzo <i>Use</i>	Portable, extra hard usage
Riferimenti normativi costruttivi <i>Standards of construction</i>	UL/CSA Approvals: Class 1, Div. 1 & Div. 2 NEC Art. 400, 501, 502; CSA C22.1 (CE Code); C22.2 No. 96; UL 1650
Riferimenti normativi d'impiego <i>Standards of use</i>	NFPA 70 (NEC) Art. 400, 501, 502; CSA C22.1 (CE Code)

Per assicurare la corretta destinazione d'uso definite nel NEC si è deciso di mantenere la versione linguistica originaria.

Codifiche e dimensioni - Coding and dimensions

Codice <i>Code</i>	Type	Numero di conduttori <i>Number of conductors</i>	Sezione <i>Size</i> [AWG/kcmil]	Conduttore di terra <i>Ground wire</i>	Ground check [AWG]	Diametro <i>Diameter</i> [mm]	Tensione <i>Voltage</i> [V]	Portata ⁽¹⁾ <i>Current</i> ⁽¹⁾ [A]	Colorazione dei conduttori <i>Conductors' colors</i>
CV03XW08_80150_NE	G-GC	3	8 AWG	2x10 AWG	10	24,6	2000	65	Nero, bianco, rosso <i>Black, white, red</i>
CV03XW06_80150_NE	G-GC	3	6	2x10 AWG	10	26,7	2000	87	Nero, bianco, rosso <i>Black, white, red</i>
CV03XW04_80150_NE	G-GC	3	4	2x8 AWG	10	30,2	2000	114	Nero, bianco, rosso <i>Black, white, red</i>
CV03XW02_80150_NE	G-GC	3	2	2x7 AWG	10	34	2000	152	Nero, bianco, rosso <i>Black, white, red</i>
CV03XW01_80150_NE	G-GC	3	1	2x6 AWG	8	38,4	2000	177	Nero, bianco, rosso <i>Black, white, red</i>
CV03XW/1_80150_NE	G-GC	3	1/0	2x5 AWG	8	41,9	2000	205	Nero, bianco, rosso <i>Black, white, red</i>
CV03XW/2_80150_NE	G-GC	3	2/0	2x4 AWG	8	44,5	2000	237	Nero, bianco, rosso <i>Black, white, red</i>
CV03XW/3_80150_NE	G-GC	3	3/0	2x3 AWG	8	48	2000	274	Nero, bianco, rosso <i>Black, white, red</i>
CV03XW/4_80150_NE	G-GC	3	4/0	2x2 AWG	8	51,8	2000	316	Nero, bianco, rosso <i>Black, white, red</i>
CV03XX25_80150_NE	G-GC	3	250 kcmil	2x2 AWG	8	60,7	2000	352	Nero, bianco, rosso <i>Black, white, red</i>

(1) Valori basati su una temperatura ambiente di 30°C considerando che un conduttore sia di terra (oltre i 3 conduttori). Fare riferimento all'Art. 400 del NFPA 70 (NEC) per maggiori dettagli.

(1) Values based on an ambient temperature of 30°C, considering that a conductor is grounded (over 3 conductors). Refer to Art. 400 of NFPA 70 (NEC) for more details.

Codice Code	Type	Numero di conduttori Number of conductors	Sezione Size [AWG/kcmil]	Conduttore di terra Ground wire	Ground check [AWG]	Diametro Diameter [mm]	Tensione Voltage [V]	Portata ⁽¹⁾ Current ⁽¹⁾ [A]	Colorazione dei conduttori Conductors' colors
CV03XX35_80150_NE	G-GC	3	350	2x1/0 AWG	8	68,1	2000	433	Nero, bianco, rosso Black, white, red
CV03XX50_80150_NE	G-GC	3	500	2x2/0 AWG	8	77	2000	536	Nero, bianco, rosso Black, white, red
CV04XW08_80155_NE	G	4	8 AWG	4x12 AWG	-	25,1	600/2000	52	Nero, bianco, rosso, arancione Black, white, red, orange
CV04XW06_80155_NE	G	4	6	4x12 AWG	-	27,9	600/2000	69	Nero, bianco, rosso, arancione Black, white, red, orange
CV04XW04_80155_NE	G	4	4	4x10 AWG	-	32,3	600/2000	91	Nero, bianco, rosso, arancione Black, white, red, orange
CV04XW02_80155_NE	G	4	2	4x9 AWG	-	37,6	600/2000	121	Nero, bianco, rosso, arancione Black, white, red, orange
CV04XW01_80155_NE	G	4	1	4x8 AWG	-	42,7	600/2000	141	Nero, bianco, rosso, arancione Black, white, red, orange
CV04XW/1_80155_NE	G	4	1/0	4x7 AWG	-	45,5	600/2000	164	Nero, bianco, rosso, arancione Black, white, red, orange
CV04XW/2_80155_NE	G	4	2/0	4x6 AWG	-	49	600/2000	189	Nero, bianco, rosso, arancione Black, white, red, orange
CV04XW/3_80155_NE	G	4	3/0	4x5 AWG	-	52,6	600/2000	219	Nero, bianco, rosso, arancione Black, white, red, orange
CV04XW/4_80155_NE	G	4	4/0	4x4 AWG	-	57,4	600/2000	252	Nero, bianco, rosso, arancione Black, white, red, orange
CV04XX25_80155_NE	G	4	250 kcmil	4x3 AWG	-	67,6	2000	281	Nero, bianco, rosso, arancione Black, white, red, orange
CV04XX35_80155_NE	G	4	350	4x2 AWG	-	75,7	2000	346	Nero, bianco, rosso, arancione Black, white, red, orange
CV04XX50_80155_NE	G	4	500	4x1/0 AWG	-	86,4	2000	428	Nero, bianco, rosso, arancione Black, white, red, orange

(1) Valori basati su una temperatura ambiente di 30°C considerando che un conduttore sia di terra (oltre i 3 conduttori). Fare riferimento all'Art. 400 del NFPA 70 (NEC) per maggiori dettagli.

(1) Values based on an ambient temperature of 30°C, considering that a conductor is grounded (over 3 conductors). Refer to Art. 400 of NFPA 70 (NEC) for more details.

**SERIES
20070**

Festoon Cable Neoprene



"UL-CSA Listed"



Impiego - Use

Cavo festone in neoprene progettato per l'alimentazione ed il controllo di gru, argani o qualsiasi altra apparecchiatura che opera in movimento laterale secondo quanto specificato nell'articolo 610 del ANSI/NFPA 70 "National Electrical Code" (NEC) in accordo con le metodologie di cablaggio indicate nell'Art. 610.11(E) "Flexibility to Moving Parts". Sono adatti per applicazioni sia all'interno che all'esterno a bassissime temperature.

Neoprene festoon cable planned for the power supply and the control of cranes, winches or other equipment working with side motion according to the specifications of Art. 610 of ANSI/NFPA 70 "National Electrical Code" (NEC), in compliance with the harness methods indicated by Art. 610.11(E) "Flexibility to Moving Parts". They can be used also in a narrow space with a suggested radius of curvature three up to five times the cable diameter. They are suitable for both indoors and outdoors applications at very low temperatures.

Informazione. Si prega di chiedere all'ufficio commerciale la possibilità del servizio aggiuntivo di taglio a misura certificato UL ("Processed Wire").

Information. Please ask the sales department for the possibility of an additional UL certified cut-to-size service ("Processed Wire").

Dati tecnici - Technical data

Caratteristica - Characteristics	Valore/proprietà - Value/property
Identificazione <i>Identification</i>	Flat festoon cable
Isolamento <i>Insulation</i>	Termoisolante <i>Thermoset</i>
Guaina <i>Jacket</i>	Neoprene resistente alla fiamma e agli olii, colore nero <i>Neoprene oil and flame resistant, black color oil and flame resistant</i>
Tensione <i>Voltage</i>	600V
Temperatura di esercizio <i>Temperature range</i>	-50°C; +90°C
Raggio di curvatura <i>Bending radius</i>	5 volte il diametro esterno del cavo <i>5 x external cable diameter</i>
Riferimenti normativi costruttivi <i>Standards of construction</i>	UL/CSA approvals: Festoon Cable NEC Art. 610; CSA C22.1 (CE Code); UL 62
Riferimenti normativi d'impiego <i>Standards of use</i>	NFPA 70 (NEC) Art. 610, CSA C22.1 (CE Code)

Codifiche e dimensioni - Coding and dimensions

Codice <i>Code</i>	Numero di conduttori <i>Number of conductors</i>	Sezione <i>Size [AWG]</i>	Dimensioni <i>Dimensions [mm]x[mm]</i>	Portata <i>Current [A]</i>	Colorazione dei conduttori <i>Color of conductors</i>
CV04XW14_20070_NE	4	14	7,5 x 22,0	18	Marrone, blu, giallo/verde, nero <i>Brown, blue, yellow/green, black</i>
CV04XW12_20070_NE	4	12	8,0 x 24,0	23	Marrone, blu, giallo/verde, nero <i>Brown, blue, yellow/green, black</i>
CV04XW10_20070_NE	4	10	8,6 x 26,5	29	Marrone, blu, giallo/verde, nero <i>Brown, blue, yellow/green, black</i>
CV04XW08_20070_NE	4	8	11,4 x 35,7	41	Marrone, blu, giallo/verde, nero <i>Brown, blue, yellow/green, black</i>
CV04XW06_20070_NE	4	6	12,3 x 39,1	55	Marrone, blu, giallo/verde, nero <i>Brown, blue, yellow/green, black</i>
CV04XW04_20070_NE	4	4	13,6 x 44,2	71	Marrone, blu, giallo/verde, nero <i>Brown, blue, yellow/green, black</i>
CV04XW02_20070_NE	4	2	15,2 x 50,8	95	Marrone, blu, giallo/verde, nero <i>Brown, blue, yellow/green, black</i>
CV04XW/1_20070_NE	4	1/0	20,3 x 58,4	132	Marrone, blu, giallo/verde, nero <i>Brown, blue, yellow/green, black</i>
CV04XW/2_20070_NE	4	2/0	20,8 x 70,9	149	Marrone, blu, giallo/verde, nero <i>Brown, blue, yellow/green, black</i>
CV04XW/3_20070_NE	4	3/0	21,6 x 73,9	167	Marrone, blu, giallo/verde, nero <i>Brown, blue, yellow/green, black</i>
CV04XW/4_20070_NE	4	4/0	24,9 x 87,2	188	Marrone, blu, giallo/verde, nero <i>Brown, blue, yellow/green, black</i>
CV08XW16_20070_NE	8	16	6,2 x 30,4	14	Verificare in fase d'ordine <i>To be verified upon order receipt</i>
CV08XW14_20070_NE	8	14	7,5 x 40,9	16	Verificare in fase d'ordine <i>To be verified upon order receipt</i>

Codifiche e dimensioni - Coding and dimensions

Codice <i>Code</i>	Numero di conduttori <i>Number of conductors</i>	Sezione Size [AWG]	Dimensioni <i>Dimensions [mm]x[mm]</i>	Portata <i>Current [A]</i>	Colorazione dei conduttori <i>Color of conductors</i>
CV08XW12_20070_NE	8	12	8,0 x 45,0	20	Verificare in fase d'ordine <i>To be verified upon order receipt</i>
CV12XW16_20070_NE	12	16	6,2 x 30,4	14	Verificare in fase d'ordine <i>To be verified upon order receipt</i>
CV12XW14_20070_NE	12	14	7,5 x 59,8	16	Verificare in fase d'ordine <i>To be verified upon order receipt</i>

Composizione del codice - Code composition

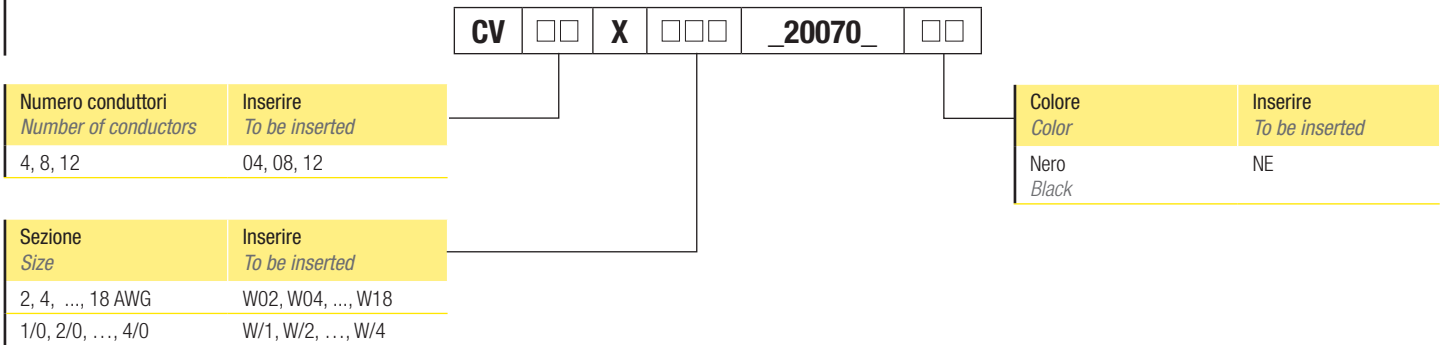

“UL-CSA Listed” schermati e non schermati - shielded and unshielded



Impiego - Use

Cavo festone in PVC progettato per l'alimentazione ed il controllo di gru, argani o qualsiasi altra apparecchiatura che opera in movimento laterale secondo quanto specificato nell'articolo 610 del ANSI/NFPA 70 "National Electrical Code" (NEC) in accordo con le metodologie di cablaggio indicate nell'Art. 610.11(E) "Flexibility to Moving Parts". Sono adatti per applicazioni sia all'interno che all'esterno. Questo cavo è adatto a temperature da -40°C fino ad oltre 100°C, tuttavia per applicazioni a temperature inferiori a -10°C in cui è soggetto a severe sollecitazioni meccaniche (flessione ed impatto) si suggerisce l'impiego del cavo festone in neoprene.

PVC festoon cable planned for the power supply and the control of cranes, winches or other equipment working with side motion according to the specifications of Art. 610 of ANSI/NFPA 70 "National Electrical Code" (NEC) in compliance with the harness methods indicated by Art. 610.11(E) "Flexibility to Moving Parts". They can be used also in a narrow space with a suggested radius of curvature three up to five times the cable diameter. They are suitable for both indoors and outdoors applications. This cable is suitable for temperatures from 40°C up to and beyond 100°C. Anyway, for applications at temperatures below 10°C where it is subject to severe mechanical stress (flexion and impact) we suggest the employment of the neoprene festoon cable.

Informazione. Si prega di chiedere all'ufficio commerciale la possibilità del servizio aggiuntivo di taglio a misura certificato UL ("Processed Wire").

Information. Please ask the sales department for the possibility of an additional UL certified cut-to-size service ("Processed Wire").

Dati tecnici - Technical data

Caratteristica - Characteristics	Valore/proprietà - Value/property
Identificazione <i>Identification</i>	Flat festoon cable
Isolamento <i>Insulation</i>	PVC resistente alla fiamma e agli olii, colore nero <i>PVC oil and flame resistant, black color</i>
Schermatura <i>Shield</i>	Vedi tabella "Codifiche e dimensioni" <i>See "Coding and dimensions" table below</i>
Guaina <i>Jacket</i>	PVC resistente alla fiamma e agli olii, colore nero <i>PVC oil and flame resistant, black color</i>
Tensione <i>Voltage</i>	600V
Temperatura di esercizio <i>Temperature range</i>	-10°C; +105°C
Raggio di curvatura <i>Bending radius</i>	10 volte il diametro esterno del cavo <i>10 x cable outer diameter</i>
Riferimenti normativi costruttivi <i>Standards of construction</i>	UL/CSA approvals: Festoon Cable NEC Art. 610; CSA C22.1 (CE Code); UL 62
Riferimenti normativi d'impiego <i>Standards of use</i>	NFPA 70 (NEC) Art. 610, CSA C22.1 (CE Code)

Codifiche e dimensioni - Coding and dimensions

Codice <i>Code</i>	Schermato <i>Shielded</i>	Numero di conduttori <i>Number of conductors</i>	Sezione Size [AWG]	Dimensioni Dimensions [mm]x[mm]	Portata Current [A]	Colorazione dei conduttori <i>Conductors' colors</i>
CV04XW16_20020_NE	No	4	16	5,7 x 16,0	17	Nero, rosso, blu, arancione <i>Black, red, blu, orange</i>
CV04XW14_20020_NE	No	4	14	6,1 x 17,5	20	Nero, rosso, blu, arancione <i>Black, red, blu, orange</i>
CV04XW12_20020_NE	No	4	12	6,6 x 20,3	25	Nero, rosso, blu, arancione <i>Black, red, blu, orange</i>
CV04XW10_20020_NE	No	4	10	7,4 x 22,6	32	Nero, rosso, blu, arancione <i>Black, red, blu, orange</i>
CV04XW08_20020_NE	No	4	8	9,5 x 31,1	45	Nero, rosso, blu, arancione <i>Black, red, blu, orange</i>
CV04XW06_20020_NE	No	4	6	11,0 x 37,8	60	Nero, rosso, blu, arancione <i>Black, red, blu, orange</i>
CV04XW04_20020_NE	No	4	4	13,1 x 44,5	78	Nero, rosso, blu, arancione <i>Black, red, blu, orange</i>
CV04XW02_20020_NE	No	4	2	14,6 x 50,2	104	Nero, rosso, blu, arancione <i>Black, red, blu, orange</i>
CV05XW12_20020_NE	No	5	12	6,6 x 25,1	22	Nero, bianco, verde, rosso, blu <i>Black, red, green, orange, blu</i>
CV05XW10_20020_NE	No	5	10	7,4 x 29,2	32	Nero, bianco, verde, rosso, blu <i>Black, red, green, orange, blu</i>
CV05XW06_20020_NE	No	5	6	11,4 x 48,8	60	Arancione, giallo, nero, grigio, marrone <i>Orange, yellow, black, Gray, brown</i>
CV05XW04_20020_NE	No	5	4	13,1 x 55,2	78	Arancione, giallo, nero, grigio, marrone <i>Orange, yellow, black, Gray, brown</i>
CV05XW02_20020_NE	No	5	2	14,6 x 64,8	104	Arancione, giallo, nero, grigio, marrone <i>Orange, yellow, black, Gray, brown</i>

Codice Code	Schermato Shielded	Numero di conduttori Number of conductors	Sezione Size [AWG]	Dimensioni Dimensions [mm]x[mm]	Portata Current [A]	Colorazione dei conduttori Conductors' colors
CV08XW16_20020_NE	No	8	16	5,7 x 29,7	15	Vedi Nota 1 See Note 1
CV08XW14_20020_NE	No	8	14	6,1 x 32,8	18	Vedi Nota 1 See Note 1
CV08XW12_20020_NE	No	8	12	6,6 x 36,6	22	Vedi Nota 1 See Note 1
CV12XW16_20020_NE	No	12	16	5,7 x 43,2	15	Vedi Nota 2 See Note 2
CV12XW14_20020_NE	No	12	14	6,1 x 46,4	18	Vedi Nota 2 See Note 2
CV04XW16_2002S_NE	Si Yes	4	16	6,4 x 20,3	17	Nero, rosso, blu, arancione Black, red, blue, orange
CV08XW16_2002S_NE	Si Yes	8	16	6,6 x 36,6	15	Vedi Nota 1 See Note 1
CV12XW16_2002S_NE	Si Yes	12	16	6,6 x 54	15	Vedi Nota 2 See Note 2
CV12XW14_2002S_NE	Si Yes	12	14	6,9 x 55,9	18	Vedi Nota 2 See Note 2

Nota 1. Colorazione: Nero, rosso, bu, arancione, giallo, marrone, rosso/nero, blu/nero

Nota 2. Colorazione: Nero, rosso, bu, arancione, giallo, marrone, rosso/nero, blu/nero, arancione/nero, giallo/nero, marrone/nero, nero/rosso

Note 1. Colors: Black, red, blue, orange, yellow, brown, red/black, blue/black

Note 2. Colors: Black, red, blue, orange, yellow, brown, red/black, blue/black, orange/black, yellow/black, brown/black, black/red

Composizione del codice - Code composition

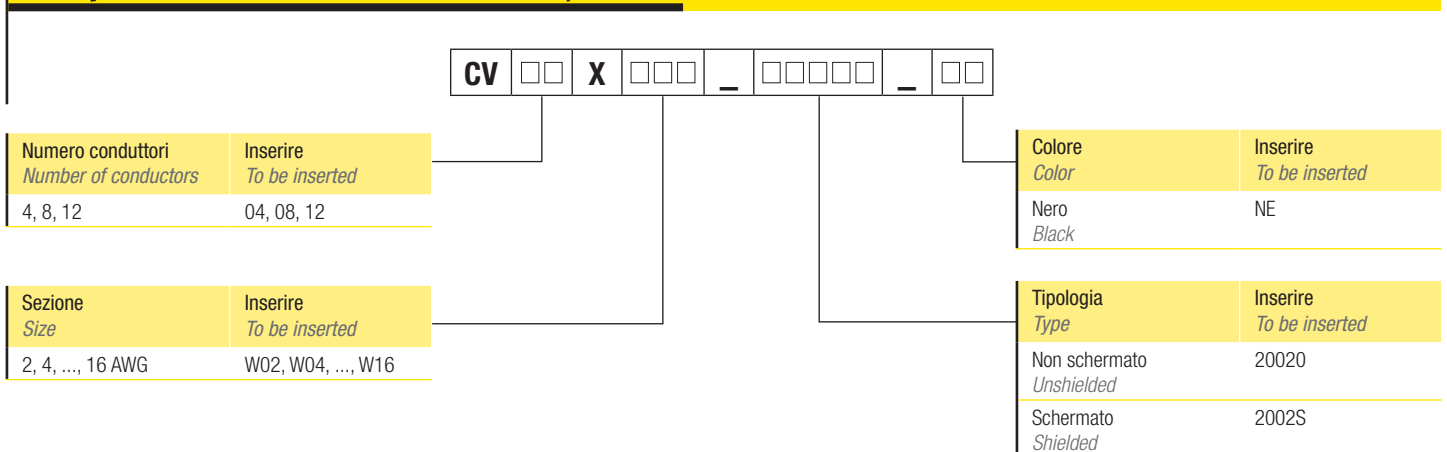

“UL Listed”, non schermati - unshielded



Impiego - Use

Cavi UL Listed non schermati (THHN/THWN or TFN) costruiti per gli usi specificati dall'articolo 336 del ANSI/NFPA 70 "National Electrical Code" (NEC) e idonei all'impiego in Class I, Division 2, Hazardous Locations. I cavi identificati con Type TC-ER (Exposed Run) possono essere installati negli impianti industriali per le connessioni tra le canaline posa cavi (cable tray) e l'apparecchiatura senza l'impiego di condotti metallici (metal conduits) o cavi armati Type MC (Metal Clad Cable); tale tipo di connessioni viene definito Open Wiring. I cavi Type TC-ER devono rispondere ai requisiti di resistenza all'impatto richiesti per i cavi Type MC.

UL Listed unshielded cables (THHN/THWN or TFN) intended for the uses specified by art. 336 of ANSI/NFPA 70 "National Electrical Code" (NEC) and suitable for use in Class I, Division 2, Hazardous Locations. The cables identified with Type TC-ER (Exposed Run) can be installed in the industrial establishments for the connections between cable trays and equipment without the employment of metal conduits or armored Type MC cables (Metal Clad Cable); this type of connections is called Open Wiring. Type TC-ER cables must meet impact resistance requirements required for Type MC cables.

Informazione. Si prega di chiedere all'ufficio commerciale la possibilità del servizio aggiuntivo di taglio a misura certificato UL ("Processed Wire").
Information. Please ask the sales department for the possibility of an additional UL certified cut-to-size service ("Processed Wire").

Dati tecnici - Technical data

Secondo quanto specificato dal NEC i cavi TC (tray cable) possono essere utilizzati per gli usi seguenti¹ :

According to NEC, the TC cables (tray cable) can be employed as follows¹ :

- (1) For power, lighting, control and signal circuits.
- (2) In cable trays.
- (3) In raceways.
- (4) In outdoor locations supported by a messenger wire.
- (5) For Class 1 circuits as permitted in Parts II and III of Article 725 (NEC).
- (6) For non-power-limited fire alarm circuits if conductors comply with the requirements of Article 760.27 (NEC).
- (7) In industrial establishments where the conditions of maintenance and supervision ensure that only qualified persons service the installation, and where the cable is continuously supported and protected against physical damage using mechanical protection, such as struts, angles, or channels... (see Article 336.10).
- (8) Where installed in wet locations, type TC cable shall also be resistant to moisture and corrosive agents.

¹ Per assicurare la corretta destinazione d'uso definita nel NEC si è deciso di mantenere la versione linguistica originaria.

Caratteristica <i>Characteristics</i>	Valore/proprietà <i>Value/property</i>
Conduttore <i>Conductor</i>	Trefolo di rame <i>Copper strand</i>
Isolamento <i>Insulation</i>	PVC/Nylon
Distinzione conduttori <i>Conductor distinction</i>	ICEA Metodo 1, tabella E-2 (vedi appendice) per sezioni 18 AWG ÷ 10 AWG ICEA Metodo 4 per sezioni 8 AWG ÷ 4/0 AWG (neri numerati) <i>ICEA Method 1, table E-2 (see appendix) for sizes 18 AWG ÷ 10 AWG</i> <i>ICEA Method 4 for sizes 8 AWG ÷ 4/0 AWG (black numbered)</i>
Conduttore di terra <i>Ground wire</i>	Rame nudo per sezioni 8 AWG ÷ 4/0 AWG <i>Bare copper for sizes 8 AWG ÷ 4/0 AWG</i>
Guaina <i>Jacket</i>	PVC resistente agli olii, colore nero <i>PVC oil-resistant, black color</i>
Temperatura di esercizio <i>Temperature range</i>	+90°C (dry conditions), +75°C (wet conditions)
Tensione nominale <i>Voltage rating</i>	600 V
Raggio di curvatura <i>Bending radius</i>	Vedi Article 336.24 (NEC) <i>See Article 336.24 (NEC)</i>
Riferimenti normativi costruttivi <i>Standards of construction</i>	UL/CSA approvals: (UL) Type TC-ER (Exposed Run), Class 1, Div. 2 NEC Art. 336, 392, 501; CSA C22.1 Tab.19; UL 1581, UL 1277, CSA C22.2 No.230, CSA C22.2 No. 239
Riferimenti normativi d'impiego <i>Standards of use</i>	NFPA 70 (NEC), CSA C22.1 (CE Code)

Codifiche e dimensioni - Coding and dimensions

Codice <i>Code</i>	Numero di conduttori <i>Number of conductors</i>	Sezione <i>Size [AWG/kcmil]</i>	Sezione conduttore di terra <i>Ground wire size [AWG]</i>	Diametro <i>Diameter [mm]</i>	Peso <i>Weight [kg/km]</i>
CV02XW18_81000_NE*	2	18 AWG	-	6,9	57
CV02XW16_81000_NE*	2	16	-	7,6	74
CV02XW14_81000_NE*	2	14	-	8,1	95
CV02XW12_81000_NE*	2	12	-	9,0	127
CV02XW10_81000_NE*	2	10	-	10,7	171
CV03XW18_81000_NE	3	18	-	7,2	68
CV03XW16_81000_NE	3	16	-	8,0	89
CV03XW14_81000_NE	3	14	-	8,8	119

Codice Code	Numero di conduttori Number of conductors	Sezione Size [AWG/kcmil]	Sezione conduttore di terra Ground wire size [AWG]	Diametro Diameter [mm]	Peso Weight [kg/km]
CV03XW12_81000_NE	3	12	-	9,8	164
CV03XW10_81000_NE	3	10	-	11,4	234
CV03XW08_81000_NE	3	8	10	15,2	458
CV03XW06_81000_NE	3	6	8	17,5	646
CV03XW04_81000_NE	3	4	8	22,3	967
CV03XW02_81000_NE	3	2	6	25,4	1435
CV03XW/1_81000_NE	3	1/0	6	31,1	2153
CV03XW/2_81000_NE	3	2/0	6	33,5	2610
CV03XW/4_81000_NE	3	4/0	4	39,2	3914
CV03XX25_81000_NE	3	250 kcmil	4	44,2	4728
CV03XX35_81000_NE	3	350	3	50,55	6344
CV03XX50_81000_NE	3	500	2	57,66	8765
CV04XW18_81000_NE	4	18 AWG	-	7,9	83
CV04XW16_81000_NE	4	16	-	8,6	110
CV04XW14_81000_NE	4	14	-	9,3	149
CV04XW12_81000_NE	4	12	-	10,7	205
CV04XW10_81000_NE	4	10	-	12,8	311
CV04XW08_81000_NE	4	8	10	16,6	555
CV04XW06_81000_NE	4	6	8	19,3	793
CV04XW04_81000_NE	4	4	8	24,6	1226
CV04XW02_81000_NE	4	2	6	27,9	1826
CV04XW/1_81000_NE	4	1/0	6	34,5	2723
CV04XW/2_81000_NE	4	2/0	6	37,0	3351
CV04XW/4_81000_NE	4	4/0	4	45,0	5212
CV04XX25_81000_NE	4	250 kcmil	4	49,4	6112
CV04XX35_81000_NE	4	350	3	55,63	8312
CV04XX50_81000_NE	4	500	2	63,63	11450
CV05XW18_81000_NE	5	18 AWG	-	8,5	97
CV05XW16_81000_NE	5	16	-	9,4	144
CV05XW14_81000_NE	5	14	-	10,4	176
CV05XW12_81000_NE	5	12	-	11,3	246
CV05XW10_81000_NE	5	10	-	14,5	399
CV07XW18_81000_NE	7	18	-	9,1	122
CV07XW16_81000_NE	7	16	-	10,2	165
CV07XW14_81000_NE	7	14	-	11,3	228
CV07XW12_81000_NE	7	12	-	12,5	323
CV07XW10_81000_NE	7	10	-	15,8	521
CV09XW18_81000_NE	9	18	-	10,7	156
CV09XW16_81000_NE	9	16	-	11,7	210
CV09XW14_81000_NE	9	14	-	12,8	317
CV09XW12_81000_NE	9	12	-	15,4	442
CV09XW10_81000_NE	9	10	-	18,4	655
CV10XW18_81000_NE	10	18	-	10,8	170
CV10XW16_81000_NE	10	16	-	12,6	229
CV12XW18_81000_NE	12	18	-	11,3	195
CV12XW16_81000_NE	12	16	-	12,8	265
CV12XW14_81000_NE	12	14	-	15,1	397
CV12XW12_81000_NE	12	12	-	17,2	561
CV12XW10_81000_NE	12	10	-	20,7	869
CV15XW18_81000_NE	15	18	-	12,3	241
CV15XW16_81000_NE	15	16	-	15,4	356
CV16XW18_81000_NE	16	18	-	12,7	249
CV16XW16_81000_NE	16	16	-	15,2	359
CV18XW18_81000_NE	18	18	-	14,5	292
CV18XW16_81000_NE	18	16	-	16,0	n.a.
CV18XW14_81000_NE	18	14	-	17,8	n.a.
CV18XW12_81000_NE	18	12	-	19,6	n.a.
CV19XW18_81000_NE	19	18	-	14,5	311
CV19XW16_81000_NE	19	16	-	16,1	423

Codice <i>Code</i>	Numero di conduttori <i>Number of conductors</i>	Sezione <i>Size [AWG/kcmil]</i>	Sezione conduttore di terra <i>Ground wire size [AWG]</i>	Diametro <i>Diameter [mm]</i>	Peso <i>Weight [kg/km]</i>
CV19XW14_81000_NE	19	14	-	17,7	589
CV19XW12_81000_NE	19	12	-	19,9	845
CV25XW18_81000_NE	25	18	-	16,6	396
CV25XW16_81000_NE	25	16	-	17,9	542
CV25XW14_81000_NE	25	14	-	19,9	755
CV25XW12_81000_NE	25	12	-	23,9	1153
CV30XW18_81000_NE	30	18	-	17,7	461
CV30XW16_81000_NE	30	16	-	19,3	634
CV30XW14_81000_NE	30	14	-	22,7	948
CV30XW12_81000_NE	30	12	-	26,2	1368
CV37XW18_81000_NE	37	18	-	19,0	552
CV37XW16_81000_NE	37	16	-	22,4	821
CV37XW14_81000_NE	37	14	-	24,6	1140
CV37XW12_81000_NE	37	12	-	28,1	1637

* In accordo a NFPA 70 (NEC), questo articolo è Tray Cable (TC) ma non Exposed Run (ER).

* According to NFPA 70 (NEC) this article is Tray Cable (TC) but not Exposed Run (ER).

Composizione del codice - Code composition

CV □□ X □□□ _81000_NE

Numero conduttori <i>Number of conductors</i>	Inserire <i>To be inserted</i>
2, ..., 25	02, ..., 25

Sezione <i>size</i>	Inserire <i>To be inserted</i>
2, 4, ..., 18 AWG	W02, W04, ..., W18
250, 350, 500 kcmil	X25, X35, X50

**SERIES
8100S**

Power and Control Tray Cable, TC-ER



"UL Listed", schermati - shielded



Impiego - Use

Cavi UL Listed schermati (THHN/THWN or TFN) costruiti per gli usi specificati dall'articolo 336 del ANS/NFPA 70 "National Electrical Code" (NEC) e idonei all'impiego in Class I, Division 2, Hazardous Locations. I cavi identificati con Type TC-ER (Exposed Run) possono essere installati negli impianti industriali per le connessioni tra le canaline posa cavi (cable tray) e l'apparecchiatura senza l'impiego di condotti metallici (metal conduits) o cavi armati Type MC (Metal Clad Cable); tale tipo di connessioni viene definito Open Wiring. I cavi Type TC-ER devono rispondere ai requisiti di resistenza all'impatto richiesti per i cavi Type MC.

UL Listed shielded cables (THHN/THWN or TFN) built for the uses specified by art. 336 of ANS/NFPA 70 "National Electrical Code" (NEC) and suitable for use in Class I, Division 2, Hazardous Locations. The cables identified as Type TC-ER (Exposed Run) can be installed in industrial establishments for the connections between the cable trays and the equipment without metal conduits or armored cables Type MC (Metal Clad Cable); this kind of connections is called Open Wiring. The Type TC-ER cables have to meet the impact resistance requirements necessary for Type MC cables.

Informazione. Si prega di chiedere all'ufficio commerciale la possibilità del servizio aggiuntivo di taglio a misura certificato UL ("Processed Wire").
Information. Please ask the sales department for the possibility of an additional UL certified cut-to-size service ("Processed Wire").

Dati tecnici - Technical data

Secondo quanto specificato dal NEC i cavi TC (tray cable) possono essere utilizzati per gli usi seguenti¹ :

According to NEC, the TC cables (tray cable) can be employed as follows¹ :

- (1) For power, lighting, control and signal circuits.
- (2) In cable trays.
- (3) In raceways.
- (4) In outdoor locations supported by a messenger wire.
- (5) For Class 1 circuits as permitted in Parts II and III of Article 725 (NEC).
- (6) For non-power-limited fire alarm circuits if conductors comply with the requirements of Article 760.27 (NEC).
- (7) In industrial establishments where the conditions of maintenance and supervision ensure that only qualified persons service the installation, and where the cable is continuously supported and protected against physical damage using mechanical protection, such as struts, angles, or channels... (see Article 336.10).
- (8) Where installed in wet locations, type TC cable shall also be resistant to moisture and corrosive agents.

¹ Per assicurare la corretta destinazione d'uso definita nel NEC si è deciso di mantenere la versione linguistica originaria.

Caratteristica Characteristics	Valore/proprietà Value/property
Conduttore Conductor	Trefolo di rame Copper strand
Isolamento Insulation	PVC/Nylon
Distinzione conduttori Conductor distinction	ICEA Metodo 1, tabella E-2 (vedi appendice) ICEA Method 1, table E-2 (see appendix)
Schermatura Shield	Nastro di alluminio con filo di continuità Aluminium band with drain wire
Guaina Jacket	PVC resistente agli olii, colore nero PVC oil-resistant, black color
Temperatura di esercizio Temperature range	+90°C (dry conditions), +75°C (wet conditions)
Tensione nominale Voltage rating	600 V
Raggio di curvatura Bending radius	Vedi Article 336.24 (NEC) See Article 336.24 (NEC)
Riferimenti normativi costruttivi Standards of construction	UL/CSA approvals: (UL) Type TC-ER (Exposed Run), Class 1, Div. 2 NEC Art. 336, 392, 501; CSA C22.1 Tab.19; UL 1581, UL 1277, CSA C22.2 No.230, CSA C22.2 No. 239
Riferimenti normativi d'impiego Standards of use	NFPA 70 (NEC), CSA C22.1 (CE Code)

Codifiche e dimensioni - Coding and dimensions

Codice Code	Numero di conduttori Number of conductors	Sezione Size [AWG/kcmil]	Sezione conduttore di terra Ground wire size [AWG]	Diametro Diameter [mm]	Peso Weight [kg/km]
CV02XW18_8100S_NE*	2	18	-	7,1	60
CV02XW16_8100S_NE*	2	16	-	7,6	77
CV02XW14_8100S_NE*	2	14	-	8,4	100
CV02XW12_8100S_NE*	2	12	-	9,4	124
CV02XW10_8100S_NE*	2	10	-	10,9	177
CV03XW18_8100S_NE	3	18	-	7,4	73
CV03XW16_8100S_NE	3	16	-	8,1	94
CV03XW14_8100S_NE	3	14	-	8,9	125
CV03XW12_8100S_NE	3	12	-	9,9	165
CV03XW10_8100S_NE	3	10	-	11,7	241

Codice <i>Code</i>	Numero di conduttori <i>Number of conductors</i>	Sezione <i>Size [AWG/kcmil]</i>	Sezione conduttore di terra <i>Ground wire size [AWG]</i>	Diametro <i>Diameter [mm]</i>	Peso <i>Weight [kg/km]</i>
CV04XW18_8100S_NE	4	18	-	7,9	86
CV04XW16_8100S_NE	4	16	-	8,9	115
CV04XW14_8100S_NE	4	14	-	9,7	155
CV04XW12_8100S_NE	4	12	-	10,7	207
CV04XW10_8100S_NE	4	10	-	12,7	305
CV05XW18_8100S_NE	5	18	-	8,6	104
CV05XW16_8100S_NE	5	16	-	9,4	135
CV05XW14_8100S_NE	5	14	-	10,2	183
CV07XW18_8100S_NE	7	18	-	9,4	132
CV07XW16_8100S_NE	7	16	-	10,4	177
CV07XW14_8100S_NE	7	14	-	11,2	240
CV09XW16_8100S_NE	9	16	-	12,0	223
CV12XW16_8100S_NE	12	16	-	13,0	275

* In accordo a NFPA 70 (NEC), questo articolo è Tray Cable (TC) ma non Exposed Run (ER).

* According to NFPA 70 (NEC) this article is Tray Cable (TC) but not Exposed Run (ER).

Composizione del codice - Code composition

CV □□ X □□□ _8100S_NE

Numero conduttori <i>Number of conductors</i>	Inserire <i>To be inserted</i>
2, ..., 12	02, ..., 12

Sezione <i>Size</i>	Inserire <i>To be inserted</i>
10, 12, ..., 18 AWG	W10, W12, ..., W18

**SERIES
8150S**

Power-limited Tray Cable, PLTC/ITC



"UL Listed", multicoppia twistati e schermati - multiple pair cables, twisted and shielded



Impiego - Use

Cavi UL Listed twistati a coppie e schermati costruiti per gli usi in circuiti Class 3 specificati dall'articolo 725 del ANSI/NFPA 70 "National Electrical Code" (NEC), questi cavi sono inoltre Type ITC (Instrumentation Tray Cable) secondo l'articolo 727 del NEC ed idonei all'impiego in Class 1, Division 2, Hazardous Locations.

UL Listed multiple pair cables, twisted and shielded, built for use in Class 3 circuits, as specified by article 725 of ANSI/NFPA 70 "National Electrical Code" (NEC). Furthermore, these cables are ITC Type (Instrumentation Tray Cable) according to article 727 of NEC and suitable for use in Class 1, Division 2, Hazardous Locations.

Informazione. Si prega di chiedere all'ufficio commerciale la possibilità del servizio aggiuntivo di taglio a misura certificato UL ("Processed Wire").
Information. Please ask the sales department for the possibility of an additional UL certified cut-to-size service ("Processed Wire").

Dati tecnici - Technical data

Secondo quanto specificato dal NEC i cavi PLTC/ITC possono essere utilizzati per gli usi seguenti¹ :
According to NEC, PLTC/ITC cables can be used as follows¹ :

- (1) In cable trays.
- (2) In raceways.
- (3) In hazardous locations as permitted in 501.10, 502.10, 503.10, 504.20, 504.30, 504.80, 505.15.
- (4) Enclosed in smooth metallic sheath, continuous corrugated metallic sheath, or inter-locking tape armor applied over the non-metallic sheath in accordance with 727.6.
The cable shall be supported and secured at intervals not exceeding 1.8 m (6 ft).
- (5) Without a metallic sheath or armor between cable tray and equipment not to exceed 15 m (50 ft), where cable is supported and protected against physical damage using mechanical protection ... (see Article 727.4).
- (6) Between cable tray and equipment in lengths not to exceed 15 m (50 ft), where the cable complies with the crash and impact requirements of Type MC cable and is identified for such use ... (see Article 727.4).
- (7) As aerial cable on a messenger.
- (8) Direct buried where identified for the use.
- (9) Under raised floors in rooms containing industrial process control equipment and rackrooms where arranged to prevent damage to the cable.
- (10) Under raised floors in information technology equipment rooms ... (see Article 727.4).

¹ Per assicurare la corretta destinazione d'uso definita nel NEC si è deciso di mantenere la versione linguistica originaria.

Caratteristica Characteristics	Valore/proprietà Value/property
Conduttore Conductor	Trefolo di rame Copper strand
Isolamento Insulation	PVC
Distinzione conduttori Conductor distinction	Numerati, coppie nero/bianco Numbered, black/white pairs
Schermatura Shield	Nastro di alluminio sulle coppie e sul totale, dotato di filo di continuità Aluminium band on pairs and total, complete with drain wire
Guaina Jacket	PVC resistente alla luce e agli olii, colore nero PVC oil and sunlight-resistant, black color
Temperatura di esercizio Temperature range	+105°C
Tensione nominale Voltage rating	300 V
Riferimenti normativi costruttivi Standards of construction	UL/CSA approvals: (UL) Type TC-ER (Exposed Run), Class 1, Div. 2 NEC Art. 336, 392, 501; CSA C22.1 Tab.19; UL 1581, UL 1277, CSA C22.2 No.230, CSA C22.2 No. 239
Riferimenti normativi d'impiego Standards of use	NFPA 70 (NEC), CSA C22.1 (CE Code)

Codifiche e dimensioni - Coding and dimensions

Codice Code	Numero di conduttori Number of conductors	Sezione Size [AWG]	Diametro Diameter [mm]	Peso Weight [kg/km]
CV04XW20_8150S_NE	2 X 2	20	8,6	96
CV08XW20_8150S_NE	4 X 2	20	10,4	156

Composizione del codice - Code composition

CV □□ X □□□ _8150S_NE

Numero conduttori Number of conductors	Inserire To be inserted	Sezione Size	Inserire To be inserted
2 x 2	04	20 AWG	W20
4 x 2	08		



“UL Listed”, armati e non schermati - armored and unshielded



Impiego - Use

Cavi UL Listed armati e non schermati costruiti per gli usi specificati dall'articolo 330 del ANSI/NFPA 70 "National Electrical Code" (NEC) ed idonei all'impiego in Class I, Division 1, Hazardous Locations. Sono cavi armati realizzati specificatamente per rispondere a particolari esigenze industriali dove sono richieste durabilità, resistenza all'impatto e alla corrosione ma anche flessibilità e facilità d'impiego.

UL Listed armored and unshielded cables intended for the uses specified by article 330 of ANSI/NFPA 70 "National Electrical Code" (NEC) and suitable for use in Class I, Division 1, Hazardous Locations. These armored cables are manufactured specifically to meet the particular industrial requirements, where durability, impact and corrosion resistance, but also flexibility and easy employment are needed.

Informazione. Si prega di chiedere all'ufficio commerciale la possibilità del servizio aggiuntivo di taglio a misura certificato UL ("Processed Wire").
Information. Please ask the sales department for the possibility of an additional UL certified cut-to-size service ("Processed Wire").

Dati tecnici - Technical data

Secondo quanto specificato dal NEC i cavi MC-HL possono essere utilizzati per gli usi seguenti¹:
According to NEC, MC-HL cables can be used as follows¹:

- (1) For services, feeders and branch circuits.
- (2) For power, lighting, control and signal circuits.
- (3) Indoors or outdoors.
- (4) Exposed or concealed.
- (5) To be direct buried where identified for such use.
- (6) In cable tray where identified for such use.
- (7) In any raceways.
- (8) As aerial cable on a messenger.
- (9) In hazardous (classified) locations as permitted.
- (10) In dry locations and embedded in plaster finish on brick or other masonry except in damp or wet locations.
- (11) In wet locations where any of the following conditions are met:
 - a. The metallic covering is impervious to moisture.
 - b. A lead sheath or moisture-impervious jacket is provided under the metal covering.
 - c. The insulated conductors under the metallic covering are listed for use in wet locations.
- (12) Where single-conductor cables are used, all phase conductors and, where used, the neutral conductor shall be grouped together to minimize induced voltage on the sheath.

¹ Per assicurare la corretta destinazione d'uso definita nel NEC si è deciso di mantenere la versione linguistica originaria.

Caratteristica <i>Characteristics</i>	Valore/proprietà <i>Value/property</i>
Conduttore <i>Conductor</i>	Trefolo di rame <i>Copper strand</i>
Isolamento <i>Insulation</i>	XLPE
Distinzione conduttori <i>Conductor distinction</i>	ICEA Metodo 1, tabella E-2 (vedi appendice) per sezioni 14 AWG ÷ 10 AWG ICEA Metodo 4 per sezioni 8 AWG ÷ 4/0 AWG ICEA Method 1, table E-2 (see appendix) for sizes 14 AWG ÷ 10 AWG ICEA Method 4 for sizes 8 AWG ÷ 4/0 AWG
Conduttore di terra <i>Ground wire</i>	Rame nudo <i>Bare copper</i>
Nastratura <i>Taping</i>	Materiale sintetico <i>Synthetic material</i>
Armatura <i>Armor</i>	Guaina corrugata in alluminio <i>Aluminium corrugated armor</i>
Guaina <i>Jacket</i>	PVC
Temperatura di esercizio <i>Temperature range</i>	+90°C
Tensione nominale <i>Voltage rating</i>	600 V
Raggio di curvatura <i>Bending radius</i>	12 volte diametro esterno del cavo <i>12 x cable outer diameter</i>
Riferimenti normativi costruttivi <i>Construction reference standards</i>	UL approvals: (UL) Type MC-HL (Hazardous Locations), Class 1, Div. 1 NEC Art. 330, 501; UL 1569, UL 2225
Riferimenti normativi d'impiego <i>Standards of use</i>	NFPA 70 (NEC)

Codifiche e dimensioni - Coding and dimensions

Codice <i>Code</i>	Numero di conduttori* <i>Number of conductors*</i>	Sezione Size [AWG]	Sezione conduttore di terra <i>Ground wire size [AWG]</i>	Diametro del cordato <i>Cord diameter</i>		Diametro dell'armatura <i>Armor diameter</i>		Diametro della guaina <i>Jacket diameter</i>		Peso Weight [kg/km]
				[inch]	[mm]	[inch]	[mm]	[inch]	[mm]	
CV03XW14_82000_NE	3	14	3x18	0,39	9,91	0,555	14,1	0,66	16,8	298
CV03XW12_82000_NE	3	12	3x16	0,34	8,64	0,555	14,1	0,66	16,8	336
CV03XW10_82000_NE	3	10	3x14	0,45	11,43	0,62	15,75	0,725	18,40	464
CV04XW14_82000_NE	4	14	14	0,345	8,76	0,522	13,26	0,627	15,93	302
CV05XW14_82000_NE	5	14	14	0,38	9,65	0,532	13,51	0,634	16,1	333
CV07XW14_82000_NE	7	14	14	0,43	10,92	0,602	15,29	0,71	18,03	427
CV12XW14_82000_NE	12	14	14	0,56	14,22	0,788	20,02	0,893	22,68	632

* Escluso il conduttore di terra
* Ground wire not included

Composizione del codice - Code composition

CV □□ X □□□ _82000_NE

Numero conduttori <i>Number of conductors</i>	Inserire <i>To be inserted</i>
3, ..., 12	03, ..., 12

Sezione <i>Size</i>	Inserire <i>To be inserted</i>
10, 12, 14	W10, W12, W14

**SERIES
8200S**

Metal-Clad Cable, MC-HL



“UL Listed”, multicoppia armati e schermati - multiple pair cables, armored and shielded



Impiego - Use

Cavi UL Listed armati e schermati costruiti per gli usi specificati dall'articolo 330 del ANSI/NFPA 70 “National Electrical Code” (NEC) ed idonei all'impiego in Class I, Division 1, Hazardous Locations. Sono cavi armati realizzati specificatamente per rispondere a particolari esigenze industriali dove sono richieste durabilità, resistenza all'impatto e alla corrosione ma anche flessibilità e facilità d'impiego.

UL Listed armored and shielded cables intended for the uses specified by article 330 of ANSI/NFPA 70 “National Electrical Code” (NEC) and suitable for use in Class I, Division 1, Hazardous Locations. These armored cables are specifically made to meet particular industrial needs, where durability, impact and corrosion resistant, but also flexibility and easy use are needed.

Informazione. Si prega di chiedere all'ufficio commerciale la possibilità del servizio aggiuntivo di taglio a misura certificato UL (“Processed Wire”).
Information. Please ask the sales department for the possibility of an additional UL certified cut-to-size service (“Processed Wire”).

Dati tecnici - Technical data

Secondo quanto specificato dal NEC i cavi MC-HL possono essere utilizzati per gli usi seguenti¹:

According to NEC, MC-HL cables can be used as follows¹:

- (1) For services, feeders and branch circuits.
- (2) For power, lighting, control and signal circuits.
- (3) Indoors or outdoors.
- (4) Exposed or concealed.
- (5) To be direct buried where identified for such use.
- (6) In cable tray where identified for such use.
- (7) In any raceways.
- (8) As aerial cable on a messenger.
- (9) In hazardous (classified) locations as permitted.
- (10) In dry locations and embedded in plaster finish on brick or other masonry except in damp or wet locations.
- (11) In wet locations where any of the following conditions are met:
 - a. The metallic covering is impervious to moisture.
 - b. A lead sheath or moisture-impervious jacket is provided under the metal covering.
 - c. The insulated conductors under the metallic covering are listed for use in wet locations.
- (12) Where single-conductor cables are used, all phase conductors and, where used, the neutral conductor shall be grouped together to minimize induced voltage on the sheath.

¹ Per assicurare la corretta destinazione d'uso definita nel NEC si è deciso di mantenere la versione linguistica originaria.

Caratteristica <i>Characteristics</i>	Valore/proprietà <i>Value/property</i>
Conduttore <i>Conductor</i>	Trefolo di rame <i>Copper strand</i>
Isolamento <i>Insulation</i>	PVC/Nylon
Distinzione conduttori <i>Conductor distinction</i>	Numerati, coppie nero/bianco <i>Numbered, black/white pairs</i>
Schermatura <i>Shield</i>	Nastro di alluminio sulle coppie e sul totale, dotato di filo di continuità <i>Aluminium tape on pairs and total, complete with drain wire</i>
Guaina interna <i>Internal jacket</i>	PVC
Armatura <i>Armor</i>	Guaina corrugata in alluminio <i>Corrugated aluminium armor</i>
Guaina esterna <i>External jacket</i>	PVC, colore nero <i>PVC, black color</i>
Temperatura di esercizio <i>Temperature range</i>	+90°C
Tensione nominale <i>Voltage rating</i>	600 V
Raggio di curvatura <i>Bending radius</i>	12 volte diametro esterno del cavo <i>12 x cable outer diameter</i>
Riferimenti normativi costruttivi <i>Standards of construction</i>	UL approvals: (UL) Type MC-HL (Hazardous Locations), Class 1, Div. 1 NEC Art. 330, 501; UL 1569, UL 2225
Riferimenti normativi d'impiego <i>Standards of use</i>	NFPA 70 (NEC)

Codifiche e dimensioni - Coding and dimensions

Codice <i>Code</i>	Numero di conduttori <i>Number of conductors</i>	Sezione Size [AWG]	Diametro del cordato <i>Cord diameter</i>		Diametro guaina interna <i>Internal jacket diameter</i>		Diametro dell'armatura <i>Armor diameter</i>		Diametro guaina esterna <i>External jacket diameter</i>		Peso Weight [kg/km]
			[inch]	[mm]	[inch]	[mm]	[inch]	[mm]	[inch]	[mm]	
CV02XW16_8200S_NE	1x2	16	0,204	5,18	0,285	7,24	0,482	12,24	0,584	14,83	238
CV04XW16_8200S_NE	2x2	16	0,424	10,77	0,506	12,85	0,752	19,1	0,856	21,74	366
CV08XW16_8200S_NE	4x2	16	0,482	12,24	0,584	14,83	0,797	20,24	0,901	22,89	469
CV16XW16_8200S_NE	8x2	16	0,635	16,13	0,74	18,8	0,968	24,59	1,072	27,23	839
CV24XW16_8200S_NE	12x2	16	0,797	20,24	0,9	22,86	1,19	30,23	1,294	32,87	1133

Composizione del codice - Code composition

CV □□ X □□□ _8200S_NE

Numero conduttori <i>Number of conductors</i>	Inserire <i>To be inserted</i>
1x2, ..., 12x2	02, ..., 24

Sezione <i>Size</i>	Inserire <i>To be inserted</i>
16	W16

**SERIES
8250**

Metal-Clad Cable, Teck 90-HL



“CSA”, armati e non schermati - armored and unshielded



Impiego - Use

Cavi CSA armati e non schermati costruiti per gli usi specificati dal Canadian Electrical Code (CEC) ed idonei all'impiego in Class I, Division 1, Hazardous Locations. Sono cavi armati realizzati specificatamente per rispondere a particolari esigenze industriali dove sono richieste durabilità, resistenza all'impatto e alla corrosione ma anche flessibilità e facilità d'impiego.

CSA armored and unshielded cables built for uses specified by the Canadian Electrical Code (CEC) and suitable for use in Class I, Division 1, Hazardous Locations. These armored cables are specifically made to meet particular industrial needs, where durability, impact and corrosion resistant, but also flexibility and easy use are needed.

Informazione. Si prega di chiedere all'ufficio commerciale la possibilità del servizio aggiuntivo di taglio a misura certificato UL ("Processed Wire").

Information. Please ask the sales department for the possibility of an additional UL certified cut-to-size service ("Processed Wire").

Dati tecnici - Technical data

Caratteristica - Characteristics	Valore/proprietà - Value/property
Conduttore <i>Conductor</i>	Trefolo di rame <i>Copper strand</i>
Isolamento <i>Insulation</i>	XLPE
Distinzione conduttori <i>Conductor distinction</i>	Vedi tabella seguente <i>See following table</i>
Conduttore di terra <i>Ground wire</i>	Rame nudo <i>Bare copper</i>
Guaina interna <i>Internal jacket</i>	PVC
Armatura <i>Armor</i>	Guaina corrugata in alluminio <i>Corrugated aluminium armor</i>
Guaina esterna <i>External jacket</i>	PVC
Temperatura di esercizio <i>Temperature range</i>	+90°C
Tensione nominale <i>Voltage rating</i>	600 V
Raggio di curvatura <i>Bending radius</i>	12 volte diametro esterno del cavo <i>12 x cable outer diameter</i>
Riferimenti normativi costruttivi <i>Standards of construction</i>	CSA approvals: (CSA) Type Teck90-HL (Hazardous Locations), Class 1, Div. 2 CSA C22.1 (CE Code), CSA C22.2 No.131
Riferimenti normativi d'impiego <i>Standards of use</i>	CSA C22.1 (CE Code), CSA C22.2 No.131

Codifiche e dimensioni - Coding and dimensions

Codice <i>Code</i>	Numero di conduttori* <i>Number of conductors*</i>	Sezione Size [AWG]	Sezione conduttore di terra <i>Ground wire size [AWG]</i>	Diametro guaina interna <i>Internal jacket diameter</i>		Diametro armatura <i>Armor diameter</i>		Diametro guaina esterna <i>External jacket diameter</i>		Peso <i>Weight [kg/km]</i>	Colorazione dei conduttori <i>Colors of conductors</i>
				[inch]	[mm]	[inch]	[mm]	[inch]	[mm]		
CV03XW14_82500_NE	3	14	14	0,39	9,91	0,58	14,73	0,66	16,76	331	Nero, rosso, blu <i>Black, red, blu</i>
CV03XW12_82500_NE	3	12	14	0,43	10,92	0,62	15,75	0,7	17,78	390	Nero, rosso, blu <i>Black, red, blu</i>
CV03XW10_82500_NE	3	10	12	0,5	12,7	0,7	17,78	0,75	19,05	488	Nero, rosso, blu <i>Black, red, blu</i>
CV03XW08_82500_NE	3	8	10	0,63	16	0,83	21,08	0,9	22,86	703	Nero, rosso, blu <i>Black, red, blu</i>
CV05XW14_82500_NE	5	14	14	0,47	11,94	0,66	16,76	0,74	18,8	424	Bianco + neri numerati <i>White + black numbered</i>
CV07XW14_82500_NE	7	14	14	0,51	12,95	0,7	17,78	0,78	19,81	494	Bianco + neri numerati <i>White + black numbered</i>
CV12XW14_82500_NE	12	14	14	0,69	17,53	0,95	24,13	0,97	24,64	822	Bianco + neri numerati <i>White + black numbered</i>

* Escluso il conduttore di terra

* *Ground wire not included*

Composizione del codice - Code composition

CV □□ X □□□ _82500_NE

Numero conduttori <i>Number of conductors</i>	Inserire <i>To be inserted</i>
2, ..., 25	02, ..., 25

Sezione <i>Size</i>	Inserire <i>To be inserted</i>
8, 10, ..., 18 AWG	W08, W10, ..., W18



Cavi connettorizzati “Contek”
“Contek” connectorized cables

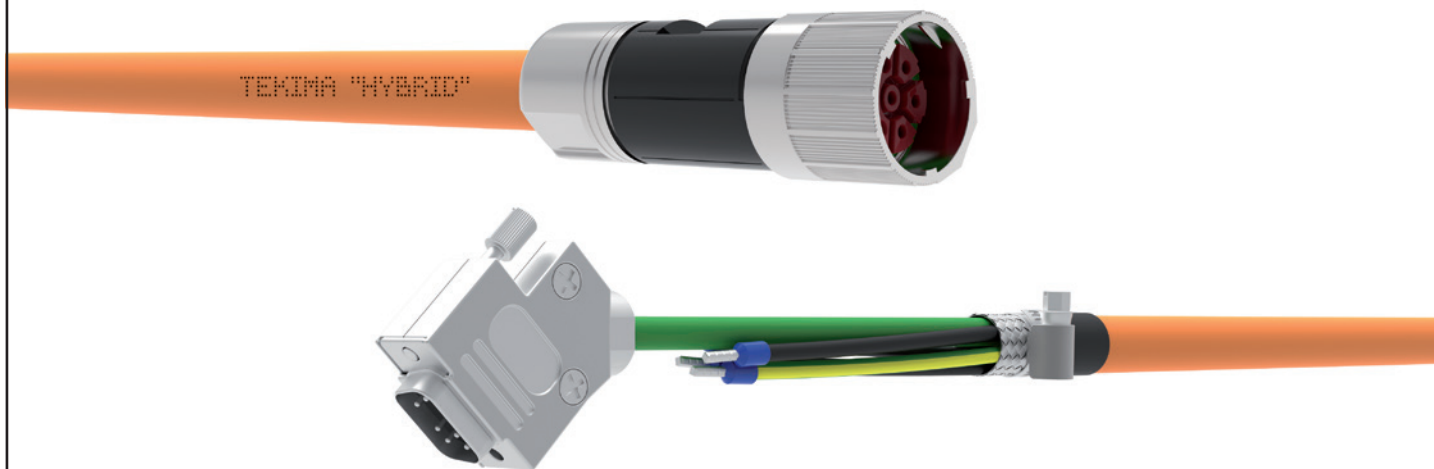

contek

Impiego - Use

La comunicazione e la potenza integrate da oggi in un singolo cavo già connettorizzato in "Contek".

Ricevi il prodotto certificato, connettorizzato, già collaudato e pronto per l'installazione come da tue specifiche.

- > Connettori compatibili con i motori e gli azionamenti più noti.
- > Configurazioni personalizzate sulla base della tua applicazione.
- > Qualità certificata di tutti i componenti.
- > Collaudo al 100%.
- > Rapidità nelle consegne.
- > Compatibilità garantita: Siemens, B&R, Control Techniques, Sew Eurodrive, Schneider Electric, Beckhoff, Bosch Rexroth, Rockwell Automation



Per maggiori informazioni scrivi a sales@tekima.com

Communication and integrated power now in a single pre-connectorized cable, "Contek".

Receive the certified, pre-connectorised product, already tested and ready to be installed as per your specifications

- > *Connectors compatible with the most used motors and drives.*
- > *Custom configurations based on your application.*
- > *Certified quality of all components.*
- > *100% tested.*
- > *Fast delivery.*
- > *Guaranteed compatibility: Siemens, B&R, Control Techniques, Sew Eurodrive, Schneider Electric, Beckhoff, Bosch Rexroth, Rockwell Automation*



For more information please contact sales@tekima.com



Raccordi e sistemi passacavo

Fittings and cable
entry systems

Pressacavi sintetici

Synthetic cable glands



Impiego - Use

La nostra linea di pressacavi sintetici è caratterizzata da una particolare geometria costruttiva che garantisce una distribuzione uniforme della forza di compressione sul cavo avendo una superficie di contatto con la guarnizione ampia e progettata per un impiego costante ed affidabile. Questi pressacavi sono prodotti in versione con filettatura corta e lunga ed assicurano una tenuta sicura sia montati con ghiera che avvitati direttamente sul foro filettato della parete del quadro. L'anello di tenuta ha una buona resistenza chimica e garantisce una classe di protezione fino a IP 68. L'ampio elemento esagonale che costituisce la ghiera facilita il montaggio sia nella fase iniziale a mano che successivamente con la chiave di serraggio.

Our synthetic cable glands are produced with a particular geometry that assures an equal cable compression having a large clamping and sealing areas designed for a secure and flexible everyday use. These cable glands are produced with a short or long thread for secure fastening with thread or counter nut. The elastic sealing rings have a good chemical resistance and they provide a reliable seal with a guaranteed IP 68 protection class. The large hexagonal element of the screw-down nuts ensures consistently reliable and secure hold when turning by hand and tightening with the tool.

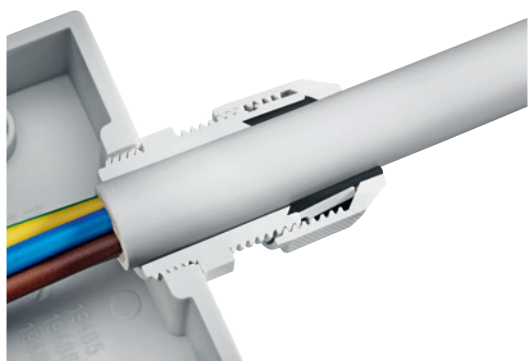

Dati tecnici - Technical data

Caratteristica - Characteristics	Valore/proprietà - Value/property
Materiale del corpo <i>Body material</i>	Poliammide PA 6 <i>Polyamide PA 6</i>
Colore <i>Color</i>	Grigio chiaro RAL 7035, Grigio scuro RAL 7001*, Nero RAL 9005* <i>Light gray RAL 7035, Dark gray RAL 7001*, Black RAL 9005*</i>
Materiale dell'anello di tenuta <i>Sealing ring material</i>	TPE/CR (Neoprene), elemento singolo <i>TPE/CR (Neoprene), one-piece.</i>
Temperatura di esercizio <i>Temperature range</i>	-30°C, +100°C
Grado di protezione <i>Protection class</i>	IP 68

* Colore solo su specifica richiesta e per quantitativo minimo applicabile.

* Color available upon request and with minimum applicable quantities

Codifiche e dimensioni - Coding and dimensions

Pressacavo dritto - Straight cable gland

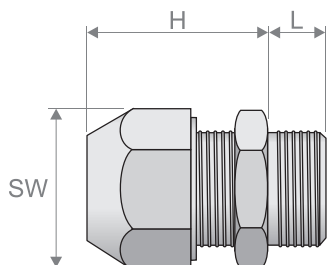

Codice <i>Code</i>	Filetto <i>Thread</i>	Chiave di serraggio <i>Tightening key</i> SW [mm]	Diametro del cavo <i>cable diameter</i> Min/Max [mm]	Dimensioni <i>Sizes</i> [mm]		Confezione <i>Packaging</i> [pz]	Nota <i>Note</i>
				H	L		
PCP100_M012X010□□	M12x1,5	15	2,5÷6,5	21,0	6,0	100	(1)
PCP100_M016X010□□	M16x1,5	19	2,0÷6,0	25,0	8,0	50	(1)
PCP100_M016X020□□	M16x1,5	19	5,0÷10,0	25,0	8,0	50	(1)
PCP100_M020X010□□	M20x1,5	24	3,5÷8,0	29,0	9,0	50	(1)
PCP100_M020X020□□	M20x1,5	24	7,0÷13,0	29,0	9,0	50	(1)
PCP100_M025X010□□	M25x1,5	29	5,0÷11,0	38,0	10,0	25	(1)

Codice Code	Filetto Thread	Chiave di serraggio Tightening key SW [mm]	Diametro del cavo cable diameter Min/Max [mm]	Dimensioni Sizes [mm]		Confezione Packaging [pz]	Nota Note
				H	L		
PCP100_M025X020□□	M25x1,5	29	10,0÷17,0	38,0	10,0	25	(1)
PCP100_M032X010□□	M32x1,5	42	17,0÷25,0	36,0	10,0	20	(2)
PCP100_P007X010□□*	Pg 7	15	2,5÷6,5	21,0	8,0	100	(1)
PCP100_P009X010□□*	Pg 9	19	3,0÷8,0	23,0	8,0	50	(1)
PCP100_P011X010□□*	Pg 11	22	2,0÷7,0	25,0	8,0	50	(1)
PCP100_P011X020□□*	Pg 11	22	4,0÷10,0	25,0	8,0	50	(4)
PCP100_P013X010□□*	Pg 13	24	3,0÷7,0	26,0	9,0	50	(1)
PCP100_P013X020□□*	Pg 13	24	5,5÷12,0	26,0	9,0	50	(5)
PCP100_P016X010□□*	Pg 16	27	5,0÷11,0	30,0	10,0	50	(1)
PCP100_P016X020□□*	Pg 16	27	8,5÷14,0	30,0	10,0	50	(2)
PCP100_P021X010□□*	Pg 21	33	6,5÷14,0	35,0	11,0	25	(1)
PCP100_P021X020□□*	Pg 21	33	11,0÷18,0	35,0	11,0	25	(2)
PCP100_P029X010□□*	Pg 29	42	17,0÷25,0	36,0	11,0	20	(2)
PCP100_P036X010□□*	Pg 36	53	22,0÷33,0	48,0	15,0	10	(2)
PCP100_P042X010□□*	Pg 42	60	28,0÷38,0	48,0	15,0	5	(2)
PCP100_P048X010□□*	Pg 48	65	32,0÷44,0	48,0	15,0	5	(6)
PCP100_N037X010□□*	NPT 3/8"	19/22	3,0÷8,0	23,0	15,0	50	(1)
PCP100_N050X010□□*	NPT 1/2"	24	3,0÷7,0	26,0	15,0	50	(1)
PCP100_N050X020□□*	NPT 1/2"	24	5,5÷12,0	26,0	15,0	50	(2)
PCP100_N075X010□□*	NPT 3/4"	33	6,5÷14,0	35,0	15,0	25	(1)
PCP100_N075X020□□*	NPT 3/4"	33	11,0÷18,0	35,0	15,0	25	(2)
PCP100_N100X010□□*	NPT 1"	42	17,0÷22,0	36,0	15,0	20	(2)

(1) Certificato c(UR)us / c(UR)us certified

(2) Certificato c(UL)us / c(UL)us certified

(4) Certificato c(UR)us per tutti i colori e c(UL)us solo nel colore nero / Certified c(UR)us in all colors and c(UL)us only in black color

(5) Certificato c(UL)us nel colore grigio scuro e nero / Certified c(UL)us in dark gray and black version

(6) Certificato c(UL)us nel colore grigio chiaro e nero / Certified c(UL)us in light gray and black version

* Prodotto non disponibile in versione grigio scuro. / Product non available in dark gray.

Pressacavo diritto lungo - Long straight cable gland

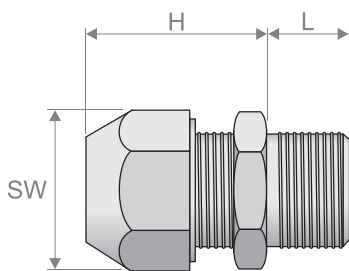

Codice Code	Filetto Thread	Chiave di serraggio Tightening key SW [mm]	Diametro del cavo cable diameter Min/Max [mm]	Dimensioni Sizes [mm]		Confezione Packaging [pz]	Nota Note
				H	L		
PCP101_M012X010□□	M12x1,5	15	2,5÷6,5	21,0	12,0	100	(1)
PCP101_M016X010□□	M16x1,5	19	2,0÷6,0	25,0	15,0	50	(1)
PCP101_M016X020□□	M16x1,5	19	5,0÷10,0	25,0	15,0	50	(1)
PCP101_M020X010□□	M20x1,5	24	3,5÷8,0	29,0	15,0	50	(1)
PCP101_M020X020□□	M20x1,5	24	7,0÷13,0	29,0	15,0	50	(1)
PCP101_M025X010□□	M25x1,5	29	5,0÷11,0	38,0	15,0	25	(1)
PCP101_M025X020□□	M25x1,5	29	10,0÷17,0	38,0	15,0	25	(1)
PCP101_M032X010□□	M32x1,5	42	17,0÷25,0	36,0	15,0	20	(2)
PCP101_M040X010□□	M40x1,5	53	22,0÷33,0	48,0	15,0	10	(2)
PCP101_M050X010□□	M50x1,5	60	28,0÷38,0	48,0	15,0	5	(2)
PCP101_M063X010□□	M63x1,5	65	32,0÷44,0	49,0	16,0	5	(3)

(1) Certificato c(UR)us / c(UR)us certified

(2) Certificato c(UL)us / c(UL)us certified

(3) Non certificato c(UR)us e c(UL)us / Not c(UR)us and c(UL)us certified

Ghiera con flangia - Lock nut with flange

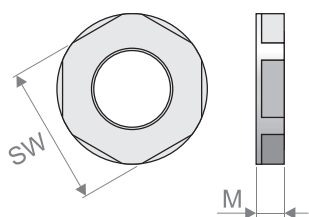

Codice Code	Filetto Thread	Chiave di serraggio Tightening key SW [mm]	Dimensioni Sizes [mm]		Confezione Packaging [pz]
			M		
PCFP10_M012□□	M12x1,5	17	5,0		100
PCFP10_M016□□	M16x1,5	22	5,0		100
PCFP10_M020□□	M20x1,5	27	6,0		100
PCFP10_M025□□	M25x1,5	33	6,7		100
PCFP10_M032□□	M32x1,5	42	7,9		50
PCFP10_M040□□	M40x1,5	48	8,4		50
PCFP10_M050□□	M50x1,5	59	9,9		10
PCFP10_M063□□	M63x1,5	73	11,0		10
PCFP10_P007□□	Pg 7	19	5,0		100
PCFP10_P009□□	Pg 9	21	5,0		100
PCFP10_P011□□	Pg 11	24	5,0		100
PCFP10_P013□□	Pg 13	27	6,0		100
PCFP10_P016□□	Pg 16	30	6,0		100
PCFP10_P021□□	Pg 21	36	7,0		50
PCFP10_P029□□	Pg 29	46	8,0		50
PCFP10_P036□□	Pg 36	59	8,0		25
PCFP10_P042□□	Pg 42	65	8,0		10
PCFP10_P048□□	Pg 48	69	8,0		10

Guarnizione - Sealing washer

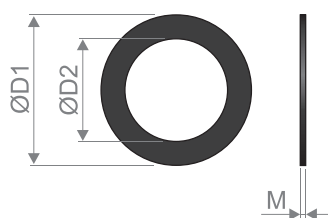

Perbunan

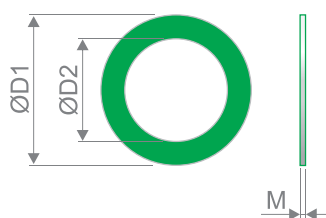

KlingerSIL C-4300

Codice Code	Filetto Thread	Materiale Material	Range di temperatura Temperature range	Dimensioni Sizes [mm]			Confezione Packaging [pz]
				ØD1	ØD1	M	
PCG040_M012	M12	Perbunan	-20°C/+100°C	20,0	12,0	1,6	50
PCG040_M016	M16	Perbunan	-20°C/+100°C	23,0	16,0	1,8	50
PCG040_M020	M20	Perbunan	-20°C/+100°C	29,0	20,0	1,8	50
PCG040_M025	M25	Perbunan	-20°C/+100°C	37,0	25,0	1,8	50
PCG040_M032	M32	Perbunan	-20°C/+100°C	44,0	32,0	2,2	25
PCG040_M040	M40	Perbunan	-20°C/+100°C	52,0	40,0	2,2	25
PCG040_M050	M50	Perbunan	-20°C/+100°C	64,0	50,0	2,7	25
PCG040_M063	M63	Perbunan	-20°C/+100°C	68,0	63,0	3,2	10
PCG040_P007	Pg 7	Perbunan	-20°C/+100°C	16,0	11,5	2,0	50
PCG040_P009	Pg 9	Perbunan	-20°C/+100°C	19,0	14,0	2,0	50
PCG040_P011	Pg 11	Perbunan	-20°C/+100°C	22,5	18,5	2,0	50
PCG040_P013	Pg 13	Perbunan	-20°C/+100°C	25,0	19,0	2,0	50
PCG040_P016	Pg 16	Perbunan	-20°C/+100°C	27,0	21,0	2,0	50
PCG040_P021	Pg 21	Perbunan	-20°C/+100°C	34,0	27,0	2,5	25
PCG040_P029	Pg 29	Perbunan	-20°C/+100°C	43,0	35,0	2,5	25
PCG040_P036	Pg 36	Perbunan	-20°C/+100°C	54,0	45,0	2,5	25

Codice Code	Filetto Thread	Materiale Material	Range di temperatura Temperature range	Dimensioni Sizes [mm]			Confezione Packaging [pz]
				ØD1	ØD1	M	
PCG030_M006	M6	KlingerSIL C-4300	-40°C/+300°C	10,0	6,0	1,5	50
PCG030_M008	M8	KlingerSIL C-4300	-40°C/+300°C	12,0	8,0	1,5	50
PCG030_M010	M10	KlingerSIL C-4300	-40°C/+300°C	14,0	10,0	1,5	50
PCG030_M012	M12	KlingerSIL C-4300	-40°C/+300°C	16,0	12,0	1,5	50
PCG030_M016	M16	KlingerSIL C-4300	-40°C/+300°C	21,0	16,0	1,5	50
PCG030_M020	M20 / Pg 13	KlingerSIL C-4300	-40°C/+300°C	25,0	20,5	1,5	50
PCG030_M025	M25	KlingerSIL C-4300	-40°C/+300°C	31,0	25,0	2,0	50
PCG030_M032	M32	KlingerSIL C-4300	-40°C/+300°C	39,0	32,0	2,0	50
PCG030_M040	M40	KlingerSIL C-4300	-40°C/+300°C	48,0	40,0	2,0	50
PCG030_M050	M50	KlingerSIL C-4300	-40°C/+300°C	59,0	50,0	2,0	50
PCG030_M063	M63	KlingerSIL C-4300	-40°C/+300°C	73,0	63,0	2,0	50
PCG030_P007	Pg 7	KlingerSIL C-4300	-40°C/+300°C	16.5	12.5	1.5	50
PCG030_P009	Pg 9	KlingerSIL C-4300	-40°C/+300°C	19.0	15.2	1.5	50
PCG030_P011	Pg 11	KlingerSIL C-4300	-40°C/+300°C	22.5	18.5	1.5	50
PCG030_P016	Pg 16	KlingerSIL C-4300	-40°C/+300°C	27.0	22.5	1.5	50
PCG030_P021	Pg 21	KlingerSIL C-4300	-40°C/+300°C	33.5	28.5	2.0	50
PCG030_P029	Pg 29	KlingerSIL C-4300	-40°C/+300°C	43.5	37.0	2.0	50
PCG030_P036	Pg 36	KlingerSIL C-4300	-40°C/+300°C	55.0	47.0	2.0	50
PCG030_P042	Pg 42	KlingerSIL C-4300	-40°C/+300°C	63.0	54.0	2.0	50
PCG030_P048	Pg 48	KlingerSIL C-4300	-40°C/+300°C	69.0	59.3	2.0	50

Composizione del codice - Code composition

Pressacavo - Cable gland



Famiglia
Family

Codice identificativo della famiglia di pressacavi.
Code depending on the glands' family.

Versione Version	Inserire To be interted
Metric	M
PG	P
NPT	N

Filetto Thread	Inserire To be interted
M12, M16, ..., M63	012, 016, ..., 063
Pg 7, Pg 9, ..., Pg 48	007, 009, ..., 048
NPT 3/8", 1/2", ..., 1"	037, 050, ..., 100

Colore Color	Inserire To be interted
Grigio chiaro RAL 7035 Light grey RAL 7035	G1
Grigio scuro RAL 7001* Dark grey RAL 7001	GR
Nero RAL 9005* Black RAL 9005*	NE

* Colore solo su specifica richiesta e per quantitativo minimo applicabile.
* Color available upon request and with minimum applicable quantities.

Range di diametri Diameter range
Codice identificativo del range di diametri di accoppiamento. Code depending on the cable range.

Ghiera - Lock nut



Famiglia
Family

Codice identificativo della famiglia di ghiera.
Code depending on the lock nuts' family.

Versione Version	Inserire To be interted
Metric	M
PG	P

Filetto Thread	Inserire To be interted
M12, M16, ..., M63	012, 016, ..., 063
Pg 7, Pg 9, ..., Pg 48	007, 009, ..., 048

Colore Color	Inserire To be interted
Grigio chiaro RAL 7035 Light grey RAL 7035	G1
Nero RAL 9005* Black RAL 9005*	NE

* Colore solo su specifica richiesta e per quantitativo minimo applicabile.
* Color available upon request and with minimum applicable quantities.

Guarnizione - Sealing washer



Famiglia
Family

Codice identificativo della famiglia di guarnizioni.
Code depending on the sealing washers' family.

Versione Version	Inserire To be interted
Metric	M
PG	P

Filetto Thread	Inserire To be interted
M12, M16, ..., M63	012, 016, ..., 063
Pg 7, Pg 9, ..., Pg 48	007, 009, ..., 048

Pressacavi metallici

Metallic cable glands



Impiego - Use

La nostra linea di pressacavi metallici è caratterizzata da una particolare geometria costruttiva che garantisce una distribuzione uniforme della forza di compressione sul cavo avendo una ampia superficie di contatto con la guarnizione ampia e progettata per un impiego costante ed affidabile. Questi pressacavi, completi di o-ring sul filetto, sono prodotti in versione con filettatura corta e lunga ed assicurano una tenuta sicura sia montati con controgghiera che avvitati direttamente sul foro filettato della parete del quadro. L'anello di tenuta ha una buona resistenza chimica e garantisce una classe di protezione fino a IP 68. L'ampio elemento esagonale che costituisce la ghiera facilita il montaggio sia nella fase iniziale a mano che successivamente con la chiave di serraggio.

Our metallic cable glands are produced with a particular geometry that assures an equal cable compression having a large clamping and sealing areas designed for a secure and flexible everyday use. These cable glands, supplied with the o-ring on thread side, are produced with a short or long thread for secure fastening with thread or counter nut. The elastic sealing rings have a good chemical resistance and they provide a reliable seal with a guaranteed IP 68 protection class. The large hexagonal element of the screw-down nuts ensures consistently reliable and secure hold when turning by hand and tightening with the tool.

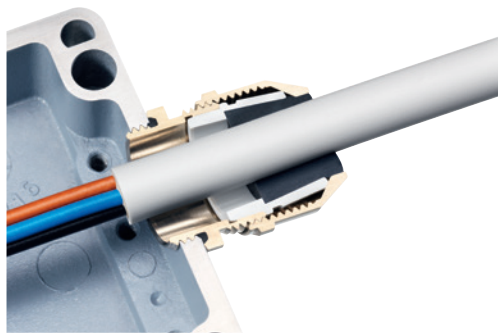

Dati tecnici - Technical data

Caratteristica - Characteristics	Valore/proprietà - Value/property
Materiale <i>Material</i>	Ottone nichelato <i>Nickel-plated brass</i>
Materiale dell'anello di tenuta <i>Sealing ring material</i>	TPE, elemento singolo <i>TPE, one-piece.</i>
Materiale dell'o-ring <i>O-ring material</i>	NBR
Temperatura di esercizio <i>Temperature range</i>	-40°C, +100°C
Grado di protezione <i>Protection class</i>	IP 68

Codifiche e dimensioni - Coding and dimensions

Pressacavo dritto - Straight cable gland

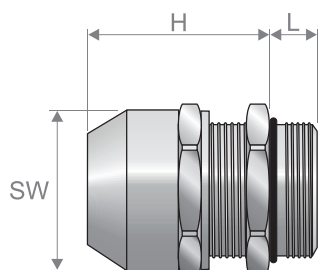

Codice <i>Code</i>	Filetto <i>Thread</i>	Chiave di serraggio <i>Tightening key</i> SW [mm]	Diametro del cavo <i>cable diameter</i> Min/Max [mm]	Dimensioni <i>Sizes</i> [mm]		Confezione <i>Packaging</i> [pz]	Nota <i>Note</i>
				H	L		
PCM100_M012X010	M12x1,5	15	1,0÷5,0	17,0	5,0	50	(1)
PCM100_M012X020	M12x1,5	15	3,0÷7,0	17,0	5,0	50	(1)
PCM100_M016X010	M16x1,5	18	2,0÷6,0	20,0	5,0	50	(1)

Codice Code	Filetto Thread	Chiave di serraggio Tightening key SW [mm]	Diametro del cavo cable diameter Min/Max [mm]	Dimensioni Sizes [mm]		Confezione Packaging [pz]	Nota Note
				H	L		
PCM100_M016X020	M16x1,5	18	4,5÷10,0	20,0	5,0	50	(1)
PCM100_M020X010	M20x1,5	22	3,5÷8,0	25,0	6,0	50	(1)
PCM100_M020X020	M20x1,5	22	7,0÷13,0	25,0	6,0	50	(1)
PCM100_M025X010	M25x1,5	28	5,0÷11,0	31,0	7,0	25	(1)
PCM100_M025X020	M25x1,5	28	10,0÷17,0	31,0	7,0	25	(1)
PCM100_M032X010	M32x1,5	36	7,0÷15,0	33,0	8,0	25	(1)
PCM100_M032X020	M32x1,5	36	13,0÷21,0	33,0	8,0	25	(1)
PCM100_M040X010	M40x1,5	46	15,0÷23,0	40,0	8,0	10	(1)
PCM100_M040X020	M40x1,5	46	19,0÷28,0	40,0	8,0	10	(1)
PCM100_M050X010	M50x1,5	55	20,0÷29,0	40,0	9,0	5	(1)
PCM100_M050X020	M50x1,5	55	25,0÷35,0	40,0	9,0	5	(1)
PCM100_M063X010	M63x1,5	70	28,0÷39,0	43,0	10,0	5	(1)
PCM100_M063X020	M63x1,5	70	35,0÷48,0	43,0	10,0	5	(1)

(1) Certificato c(UR)us / c(UR)us certified

Pressacavo diritto lungo - Long straight cable gland

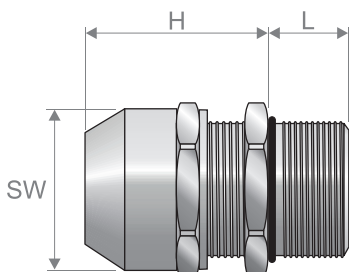

Codice Code	Filetto Thread	Chiave di serraggio Tightening key SW [mm]	Diametro del cavo cable diameter Min/Max [mm]	Dimensioni Sizes [mm]		Confezione Packaging [pz]	Nota Note
				H	L		
PCM101_M012X010	M12x1,5	15	1,0÷5,0	17,0	12,0	50	(1)
PCM101_M012X020	M12x1,5	15	3,0÷7,0	17,0	12,0	50	(1)
PCM101_M016X010	M16x1,5	18	2,0÷6,0	20,0	12,0	50	(1)
PCM101_M016X020	M16x1,5	18	4,5÷10,0	20,0	12,0	50	(1)
PCM101_M020X010	M20x1,5	22	3,5÷8,0	25,0	12,0	50	(1)
PCM101_M020X020	M20x1,5	22	7,0÷13,0	25,0	12,0	50	(1)
PCM101_M025X010	M25x1,5	28	5,0÷11,0	31,0	12,0	25	(1)
PCM101_M025X020	M25x1,5	28	10,0÷17,0	31,0	12,0	25	(1)
PCM101_M032X010	M32x1,5	36	7,0÷15,0	33,0	15,0	25	(1)
PCM101_M032X020	M32x1,5	36	13,0÷21,0	33,0	15,0	25	(1)
PCM101_M040X010	M40x1,5	46	15,0÷23,0	40,0	15,0	10	(1)
PCM101_M040X020	M40x1,5	46	19,0÷28,0	40,0	15,0	10	(1)
PCM101_M050X010	M50x1,5	55	20,0÷29,0	40,0	15,0	5	(1)
PCM101_M050X020	M50x1,5	55	25,0÷35,0	40,0	15,0	5	(1)
PCM101_M063X010	M63x1,5	70	28,0÷39,0	43,0	15,0	5	(1)
PCM101_M063X020	M63x1,5	70	35,0÷48,0	43,0	15,0	5	(1)
PCM101_M063X030	M63x1,5	80	44,0÷55,0	43,0	15,0	5	(1)

(1) Certificato c(UR)us / c(UR)us certified

Ghiera sottile - Thin lock nut

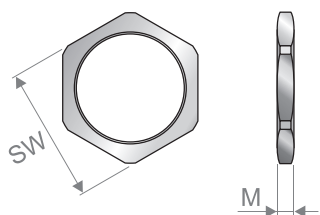

Codice Code	Filetto Thread	Chiave di serraggio Tightening key SW [mm]	Dimensioni Sizes [mm] M	Confezione Packaging [pz]
PCFM10_M012	M12x1,5	15	3,0	100
PCFM10_M016	M16x1,5	19	3,0	100
PCFM10_M020	M20x1,5	24	3,5	100
PCFM10_M025	M25x1,5	30	4,0	50
PCFM10_M032	M32x1,5	36	4,0	25
PCFM10_M040	M40x1,5	46	5,0	25
PCFM10_M050	M50x1,5	55	5,5	10
PCFM10_M063	M63x1,5	70	6,0	10
PCFM10_M075	M75x1,5	80	6,0	10
PCFM10_M080	M80x2,0	95	8,0	5
PCFM10_M085	M85x2,0	95	8,0	5
PCFM10_M095	M95x2,0	110	9,0	5
PCFM10_M100	M100x3,0	115	9,0	1
PCFM10_M105	M105x3,0	120	9,0	1
PCFM10_M115	M115x3,0	125	10,0	1

Ghiera spessa - Thick lock nut

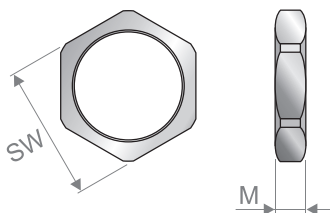

Codice Code	Filetto Thread	Chiave di serraggio Tightening key SW [mm]	Dimensioni Sizes [mm] M	Confezione Packaging [pz]
PCFM12_M012	M12x1,5	15	5,0	50
PCFM12_M016	M16x1,5	19	5,0	50
PCFM12_M020	M20x1,5	24	5,5	50
PCFM12_M025	M25x1,5	30	5,5	50
PCFM12_M032	M32x1,5	36	6,0	50
PCFM12_M040	M40x1,5	46	7,0	50

Composizione del codice - Code composition



Famglia
Family

Codice identificativo della famiglia di pressacavi.
Code depending on the glands' family.

Versione <i>Version</i>	Inserire <i>To be interted</i>
Metric	M

Filetto <i>Thread</i>	Inserire <i>To be interted</i>
M12, M16, ..., M63	012, 016, ..., 063

Range di diametri
Diameter range

Codice identificativo del range di diametri di accoppiamento.
Code depending on the cable range.

Ghiera - Lock nut

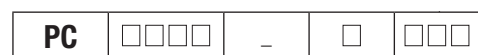

Famglia
Family

Codice identificativo della famiglia di ghiera.
Code depending on the lock nuts' family.

Versione <i>Version</i>	Inserire <i>To be interted</i>
Metric	M

Filetto <i>Thread</i>	Inserire <i>To be interted</i>
M12, M16, ..., M63	012, 016, ..., 063

Pressacavi metallici NEMA

NEMA metallic cable glands



Impiego - Use

Linea di pressacavi metallici in ottone nichelato costituiti da una guarnizione a doppio elemento che permette un ampio range di accoppiamento. Sono caratterizzati da un grado di protezione IP 68 e sono adatti all'impiego in zone a pericolo di esplosione secondo il NFPA 70 (NEC). Questi pressacavi sono certificati in accordo alla norma EN 45545-2 per applicazioni in ambito ferroviario.

Nickel plated brass cable glands made by a double layer seals to allow a wide range of diameters. They are IP 68 protection class and suitable for use in hazardous location according to NFPA 70 (NEC). These cable glands are certified for rail applications according to EN 45545-2.

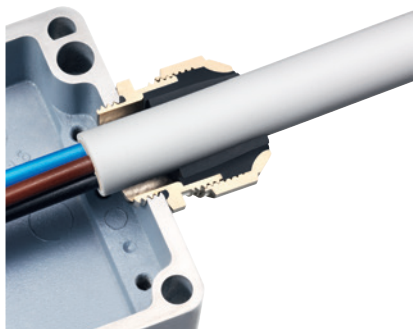

Dati tecnici - Technical data

Caratteristica - Characteristics	Valore/proprietà - Value/property
Materiale <i>Material</i>	Ottone nichelato o Acciaio inossidabile AISI 316 <i>Nickel-plated brass or AISI 316 Stainless Steel</i>
Materiale della guarnizione <i>Sealing ring material</i>	EPDM Classe V0, elemento doppio <i>EPDM Class V0, two-piece</i>
Temperatura di esercizio <i>Temperature range</i>	-45°C, +105°C
Grado di protezione <i>Protection class</i>	IP 68, NEMA 4X
Riferimenti normativi di impiego <i>Standards of use</i>	EN 45545-2 HL1, HL2, HL3, R22, R23 UUCSA approvals: NEMA 250, UL 5148, CSA C22.2; NFPA 70 (NEC) Art. 501.10 (B) (2) Class I Div. 2, Art. 502.10 (A) (2) and (B) (2) Class II, Div. 1 and 2, Art. 503.10 (A) (3) Class III Div. 1 and 2

Codifiche e dimensioni - Coding and dimensions

Pressacavo dritto - Straight cable gland

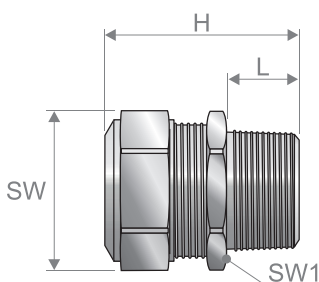

Fig. 1
Versione metrica
Metric version

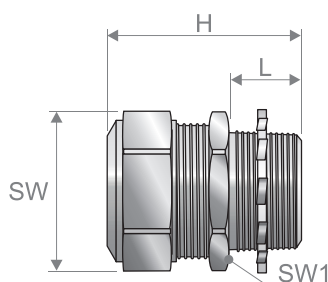

Fig. 2
Versione NPT
NPT version

Codice <i>Code</i>	Versione <i>Version</i>	Filetto <i>Thread</i>	Numero di elementi della guarnizione <i>Number of pieces of sealing ring</i>	Chiave di serraggio <i>Tightening key</i>		Diametro del cavo cable diameter [mm] Min/Med ⁽³⁾ /Max	Dimensioni <i>Sizes</i> [mm]		Confezione <i>Packaging</i> [pz]	Nota <i>Note</i>
				SW	SW1		H	L		
AN736.716.1	NPB	M16x1,5	2	17	18	4,0÷6,5÷8,5	32	10	10	(1)
AN736.717.1	NPB	M20x1,5	2	17	22	4,0÷6,5÷8,5	32	10	10	(2)
AN736.720.1	NPB	M20x1,5	2	22	22	6,0÷9,0÷12,0	35	10	10	(2)
AN736.722.1	NPB	M25x1,5	2	22	27	6,0÷9,0÷12,0	36	10	5	(2)
AN736.725.1	NPB	M25x1,5	2	27	27	10,5÷14,0÷17,0	38	10	5	(2)
AN736.728.1	NPB	M32x1,5	2	27	35	10,5÷14,0÷17,0	40	12	5	(2)
AN736.732.1	NPB	M32x1,5	2	35	35	15,5÷20,0÷24,0	42	12	5	(2)

Codice Code	Versione Version	Filetto Thread	Numero di elementi della guarnizione Number of pieces of sealing ring	Chiave di serraggio Tightening key		Diametro del cavo cable diameter [mm] Min/Med [®] /Max	Dimensioni Sizes [mm]		Confezione Packaging [pz]	Nota Note
				SW	SW1		H	L		
AN736.735.1	NPB	M40x1,5	2	35	43	15,5÷20,0÷24,0	43	13	2	(2)
AN736.740.1	NPB	M40x1,5	2	43	43	22,0÷27,0÷31,0	45	13	2	(2)
AN736.745.1	NPB	M50x1,5	2	43	55	22,0÷27,0÷31,0	46	14	2	(2)
AN736.750.1	NPB	M50x1,5	2	53	55	29,5÷35,0÷40,0	50	14	2	(2)
AN738.712.2	NPB	NPT 1/2"	2	17	24	4,0÷6,5÷8,5	36	14	10	(2)
AN738.716.2	NPB	NPT 1/2"	2	22	24	6,0÷9,0÷12,0	39	14	10	(2)
AN738.718.2	NPB	NPT 3/4"	2	22	30	6,0÷9,0÷12,0	40	14	5	(2)
AN738.720.2	NPB	NPT 3/4"	2	27	30	10,5÷14,0÷17,0	42	14	5	(2)
AN738.723.2	NPB	NPT 1"	2	27	38	10,5÷14,0÷17,0	44	16	5	(2)
AN738.726.2	NPB	NPT 1"	2	35	38	15,5÷20,0÷24,0	46	16	5	(2)
AN738.730.2	NPB	NPT 1 1/4"	2	35	48	15,5÷20,0÷24,0	46	16	2	(2)
AN738.735.2	NPB	NPT 1 1/4"	2	43	48	22,0÷27,0÷31,0	48	16	2	(2)
AN738.738.2	NPB	NPT 1 1/2"	2	43	55	22,0÷27,0÷31,0	50	18	2	(2)
AN738.740.2	NPB	NPT 1 1/2"	2	53	55	29,5÷35,0÷40,0	64	18	2	(2)
AN736.716.9	SS	M16x1,5	2	17	18	4,0÷6,5÷8,5	32	10	10	(1)
AN736.717.9	SS	M20x1,5	2	17	22	4,0÷6,5÷8,5	32	10	10	(2)
AN736.720.9	SS	M20x1,5	2	22	22	6,0÷9,0÷12,0	35	10	10	(2)
AN736.722.9	SS	M25x1,5	2	22	27	6,0÷9,0÷12,0	36	10	5	(2)
AN736.725.9	SS	M25x1,5	2	27	27	10,5÷14,0÷17,0	38	10	5	(2)
AN736.728.9	SS	M32x1,5	2	27	35	10,5÷14,0÷17,0	40	12	5	(2)
AN736.732.9	SS	M32x1,5	2	35	35	15,5÷20,0÷24,0	42	12	5	(2)
AN736.735.9	SS	M40x1,5	2	35	43	15,5÷20,0÷24,0	43	13	2	(2)
AN736.740.9	SS	M40x1,5	2	43	43	22,0÷27,0÷31,0	45	13	2	(2)
AN736.745.9	SS	M50x1,5	2	43	55	22,0÷27,0÷31,0	46	14	2	(2)
AN736.750.9	SS	M50x1,5	2	53	55	29,5÷35,0÷40,0	50	14	2	(2)
AN738.712.92	SS	NPT 1/2"	2	17	24	4,0÷6,5÷8,5	36	14	10	(2)
AN738.716.92	SS	NPT 1/2"	2	22	24	6,0÷9,0÷12,0	39	14	10	(2)
AN738.718.92	SS	NPT 3/4"	2	22	30	6,0÷9,0÷12,0	40	14	5	(2)
AN738.720.92	SS	NPT 3/4"	2	27	30	10,5÷14,0÷17,0	42	14	5	(2)
AN738.723.92	SS	NPT 1"	2	27	38	10,5÷14,0÷17,0	44	16	5	(2)
AN738.726.92	SS	NPT 1"	2	35	38	15,5÷20,0÷24,0	46	16	5	(2)
AN738.730.92	SS	NPT 1 1/4"	2	35	48	15,5÷20,0÷24,0	46	16	2	(2)
AN738.735.92	SS	NPT 1 1/4"	2	43	48	22,0÷27,0÷31,0	48	16	2	(2)
AN738.738.92	SS	NPT 1 1/2"	2	43	55	22,0÷27,0÷31,0	50	18	2	(2)
AN738.740.92	SS	NPT 1 1/2"	2	53	55	29,5÷35,0÷40,0	64	18	2	(2)

(1) Certificato (UL) Recognized e CSA. / (UL) Recognized and CSA certified.

(2) Certificato (UL) Listed e CSA. / (UL) Listed and CSA certified.

(3) Valore intermedio di passaggio ad un solo elemento di guarnizione. / Intermediate value of passage to a single sealing ring.

Legenda materiali: SS = Acciaio inossidabile, NPB = Ottone nichelato
Materials' description: SS = Stainless steel, NPB = Nickel-plated brass

Ghiera sottile - Thin lock nut

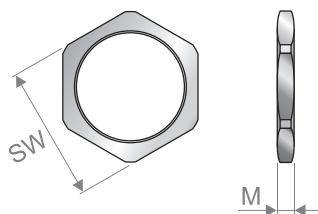

Codice Code	Filetto Thread	Chiave di serraggio Tightening key [mm]	Dimensioni Sizes [mm]	Confezione Packaging [pz]
		SW	M	
PCFM10_M016	M16x1,5	19	3,0	100
PCFM10_M020	M20x1,5	24	3,5	100
PCFM10_M025	M25x1,5	30	4,0	50
PCFM10_M032	M32x1,5	36	4,0	25
PCFM10_M040	M40x1,5	46	5,0	25
PCFM10_M050	M50x1,5	55	5,5	10

Pressacavi metallici ad alte prestazioni

High-performing metallic cable glands



Impiego - Use

Questa linea di pressacavi metallici garantisce prestazioni fino a IP 68 (10 bar) e IP 69K. Sono caratterizzati da una particolare geometria costruttiva che garantisce una distribuzione uniforme della forza di compressione sul cavo avendo una superficie di contatto con la guarnizione ampia progettata per un impiego costante ed affidabile. La guarnizione ha una buona resistenza chimica e l'ampio elemento esagonale che costituisce la ghiera facilita il montaggio sia nella fase iniziale a mano che successivamente con la chiave di serraggio.

Our high performing metallic cable glands provide a reliable seal with a guaranteed IP 68 (10 bar) and IP 69K protection classes. They are produced with a particular geometry that assures an equal cable compression having a large clamping and sealing areas designed for a secure and flexible everyday use. The elastic sealing rings have a good chemical resistance and their large hexagonal element of the screw-down nuts ensures consistently reliable and secure hold when turning by hand and tightening with the tool.

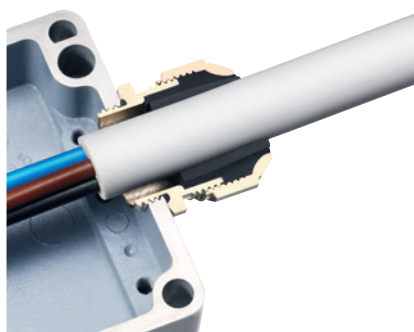

Dati tecnici - Technical data

Caratteristica - Characteristics	Valore/proprietà - Value/property
Materiale Material	Ottone nichelato Nickel-plated brass
Materiale della guarnizione Sealing ring material	TPE, elemento singolo o doppio TPE, one-piece or two-piece.
Temperatura di esercizio Temperature range	-40°C, +100°C
Grado di protezione Protection class	IP 68 (10 bar) IP 69K

Codifiche e dimensioni - Coding and dimensions

Pressacavo dritto - Straight cable gland

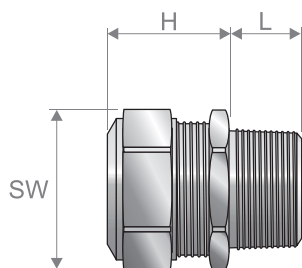

Codice Code	Filetto Thread	Numero di elementi della guarnizione Number of pieces of sealing ring	Chiave di serraggio Tightening key SW [mm]	Diametro del cavo cable diameter Min/Max [mm]	Dimensioni Sizes [mm]		Confezione Packaging [pz]	Nota Note
					H	L		
PCM200_N012X010	NPT 1/8"	1	13	3,0÷4,0	15	8	50	(2)
PCM200_N012X020	NPT 1/8"	1	13	4,0÷6,0	15	8	50	(2)
PCM200_N025X010	NPT 1/4"	1	15	3,5÷5,0	17	12	50	(2)
PCM200_N025X020	NPT 1/4"	1	15	5,0÷6,5	17	12	50	(2)
PCM200_N025X030	NPT 1/4"	1	15	6,5÷8,0	17	12	50	(2)

Codice Code	Filetto Thread	Numero di elementi della guarnizione Number of pieces of sealing ring	Chiave di serraggio Tightening key SW [mm]	Diametro del cavo cable diameter Min/Max [mm]	Dimensioni Sizes [mm]		Confezione Packaging [pz]	Nota Note
					H	L		
PCM200_N037X010	NPT 3/8"	1	18	3,5÷4,5	20	12	50	(2)
PCM200_N037X020	NPT 3/8"	1	18	4,5÷6,0	20	12	50	(2)
PCM200_N037X030	NPT 3/8"	1	18	6,0÷8,0	20	12	50	(2)
PCM202_N037X010	NPT 3/8"	2	18	6,0÷10,5	22	12	50	(1)
PCM200_N037X040	NPT 3/8"	1	18	8,0÷10,5	22	12	50	(2)
PCM200_N050X010	NPT 1/2"	1	24	6,0÷8,0	21	15	50	(2)
PCM200_N050X020	NPT 1/2"	1	24	8,0÷11,0	21	15	50	(2)
PCM202_N050X010	NPT 1/2"	2	24	8,0÷15,0	23	15	50	(3)
PCM200_N050X030	NPT 1/2"	1	24	11,0÷15,0	23	15	50	(2)
PCM200_N075X010	NPT 3/4"	1	30	9,5÷12,5	28	15	25	(2)
PCM200_N075X020	NPT 3/4"	1	30	12,5÷16,0	28	15	25	(2)
PCM202_N075X010	NPT 3/4"	2	30	12,5÷20,5	28	15	25	(2)
PCM200_N075X030	NPT 3/4"	1	30	16,0÷20,5	28	15	25	(2)
PCM200_N100X010	NPT 1"	1	36	14,0÷17,0	28	20	25	(2)
PCM200_N100X020	NPT 1"	1	36	17,0÷21,0	28	20	25	(2)
PCM202_N100X010	NPT 1"	2	36	17,0÷25,5	28	20	25	(2)
PCM200_N100X030	NPT 1"	1	36	21,0÷25,5	28	20	25	(2)
PCM200_N125X010	NPT 1 1/4"	1	46	20,0÷24,0	31	20	10	(2)
PCM200_N125X020	NPT 1 1/4"	1	46	24,0÷28,5	31	20	10	(2)
PCM202_N125X010	NPT 1 1/4"	2	46	24,0÷33,0	31	20	10	(2)
PCM200_N125X030	NPT 1 1/4"	1	46	28,5÷33,0	31	20	10	(2)
PCM200_N150X010	NPT 1 1/2"	1	55	29,0÷33,0	34	22	10	(2)
PCM200_N150X020	NPT 1 1/2"	1	55	33,0÷37,0	34	22	10	(2)
PCM202_N150X010	NPT 1 1/2"	2	55	33,0÷41,0	34	22	10	(2)
PCM200_N150X030	NPT 1 1/2"	1	55	37,0÷41,0	34	22	10	(2)
PCM200_N200X010	NPT 2"	1	70	35,0÷40,0	37	22	5	(2)
PCM200_N200X020	NPT 2"	1	70	40,0÷46,0	37	22	5	(2)
PCM202_N200X010	NPT 2"	2	70	40,0÷52,0	37	22	5	(2)
PCM200_N200X030	NPT 2"	1	70	46,0÷52,0	37	22	5	(2)

(1) Certificato c(UR)us / c(UR)us certified

(2) Certificato c(UL)us / c(UL)us certified

(3) Certificato c(UR)us e c(UL)us / c(UR)us and c(UL)us certified

Guarnizioni con anello di supporto - Sealing gasket with back plate



Codice Code	Materiale Material	Versione Version	Filetto Thread	Confezione Packaging [pz]
TB5262	AZC	NPT	1/2"	50
TB5263	AZC	NPT	3/4"	25
TB5264	AZC	NPT	1"	25
TB5265	AZC	NPT	1"1/4	5
TB5266	AZC	NPT	1"1/2	5
TB5267	AZC	NPT	2"	5
TB5268	AZC	NPT	2"1/2	1

Legenda materiali: AZC=Acciaio zincato cromato

Materials' description: AZC=Zinc plated steel

Ghiera - Lock nut

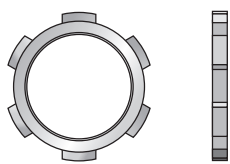

Codice <i>Code</i>	Materiale <i>Material</i>	Versione <i>Version</i>	Filetto <i>Thread</i>	Confezione <i>Packaging [pz]</i>
TB140	AGC	NPT	3/8"	100
TB141	AGC	NPT	1/2"	100
TB142	AGC	NPT	3/4"	100
TB143	AGC	NPT	1"	50
TB144	AGC	NPT	1"1/4	50
TB145	AGC	NPT	1"1/2	50
TB146	AGC	NPT	2"	25
TB147	AGC	NPT	2"1/2	15

Legenda materiali: AGC = Acciaio galvanizzato cromato
Materials' description: AGC = Chrome plated galvanized steel

Composizione del codice - Code composition

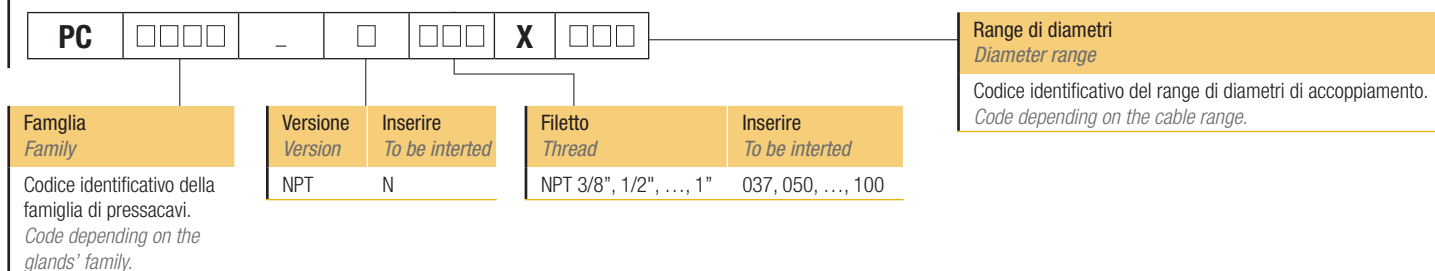

Pressacavi metallici compatibili EMC ad alte prestazioni



High-performing EMC-compatible metallic cable glands



Impiego - Use

Nel settore industriale la compatibilità elettromagnetica (EMC) riveste un ruolo fondamentale poiché le macchine e i sistemi complessi sono estremamente sensibili alle interferenze elettromagnetiche. Tali effetti indesiderati, tuttavia, possono essere contrastati con la schermatura efficace di tutti i componenti e non solo i cavi. Come componenti passivi, i pressacavi devono garantire che la qualità della schermatura nei punti sensibili delle interconnessioni rimanga intatta e che non ci siano perdite dovute alla schermatura. I pressacavi metallici compatibili EMC garantiscono un potente bloccaggio dello schermo del cavo ed una eccellente schermatura con una bassa impedenza di trasferimento. La forma della molla di contatto non solo consente un ampio campo di serraggio ma anche un facile smontaggio senza rischi di danneggiamento della treccia EMC.

I pressacavi metallici compatibili EMC sono caratterizzati da una particolare geometria costruttiva che garantisce una distribuzione uniforme della forza di compressione sul cavo avendo una ampia superficie di contatto con la guarnizione ampia e progettata per un impiego costante ed affidabile. Questi pressacavi, completi di o-ring sul filetto, sono prodotti in versione con filettatura corta e lunga ed assicurano una tenuta sicura sia montati con la speciale ghiera EMC con elementi di incisione che avvitati direttamente sul foro filettato della parete del quadro. L'anello di tenuta ha una buona resistenza chimica e garantisce una classe di protezione fino a IP 68 (10 bar) e IP 69K. Su richiesta è possibile fornire un pressacavo "multiplo" producendo un anello di tenuta personalizzato, è sufficiente definire il numero e diametro dei cavi da cablare.

The electromagnetic compatibility (EMC) in the industrial sector plays a key role because complex machines and systems are extremely susceptible to electromagnetic interference. Such undesired effects, however, can be counteracted with the effective shielding of all components and not only cables. As passive components, cable glands must ensure that the quality of the shielding at sensitive interconnection points remains intact and that there are no losses due to the shielding.

The EMC cable glands guarantee a powerful, protective clamping of the cable shield and excellent shield contact providing for the smallest possible transfer impedance. The shape of the contact spring not only allows for a large clamping range to the shield but also for easy disassembly without damaging the EMC braid.

Our EMC metallic cable glands are produced with a particular geometry that assures an equal cable compression having a large clamping and sealing areas designed for a secure and flexible everyday use. These cable glands, supplied with the o-ring on thread side, are produced with a short or long thread for secure fastening with thread or the special EMC counter nut with cutter teeth. The elastic sealing rings have a good chemical resistance and they provide a reliable seal with a guaranteed IP 68 (10 bar) and IP 69K protection classes. On request we can provide a "multiple" cable gland producing a customized sealing ring, it is sufficient to provide number and diameter of the cables to be wired.

Dati tecnici - Technical data

Caratteristica - Characteristics	Valore/proprietà - Value/property
Materiale Material	Ottone nichelato Nickel-plated brass
Materiale della molla di contatto Material of the contact spring	Acciaio Steel
Materiale dell'anello di tenuta Sealing ring material	TPE, elemento doppio TPE, two-pieces.
Materiale dell'oring O-ring material	NBR
Temperatura di esercizio Temperature range	-60°C, +100°C
Grado di protezione Protection class	IP 68 (10 bar) IP 69K

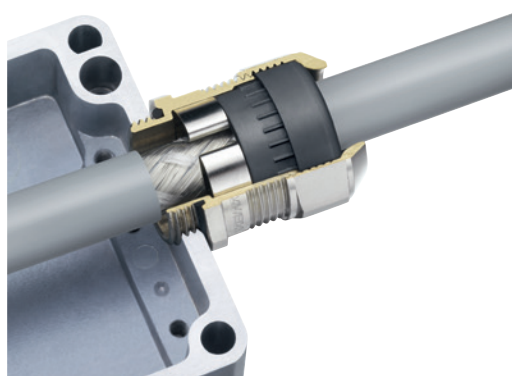

Codifiche e dimensioni - Coding and dimensions

Pressacavo diritto - Straight cable gla

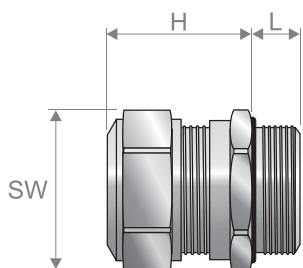

Codice Code	Filetto Thread	Chiave di serraggio Tightening key SW [mm]	Diametro del cavo cable diameter Min/Max [mm]	Dimensioni Sizes [mm]		Confezione Packaging [pz]	Nota Note
				H	L		
PCM500_M012X010	M12x1,5	15	3,5÷5,0	22,0	5,0	50	(1)
PCM500_M012X020	M12x1,5	15	5,0÷6,5	22,0	5,0	50	(1)
PCM500_M016X010	M16x1,5	18	6,0÷10,5	25,0	5,0	50	(1)
PCM500_M020X010	M20x1,5	24	8,0÷15,0	27,0	6,0	50	(1)
PCM500_M025X010	M25x1,5	30	12,5÷20,5	33,0	7,0	25	(1)
PCM500_M032X010	M32x1,5	36	17,0÷25,5	33,0	8,0	25	(1)
PCM500_M040X010	M40x1,5	46	24,0÷33,0	38,0	8,0	10	(1)
PCM500_M050X010	M50x1,5	55	33,0÷42,0	42,0	9,0	10	(1)
PCM500_M063X010	M63x1,5	70	40,0÷52,0	42,0	10,0	5	(1)

(1) Certificato c(UR)us / c(UR)us certified

Pressacavo diritto lungo - Long straight cable gland

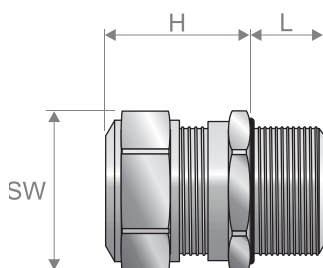

Codice Code	Filetto Thread	Chiave di serraggio Tightening key SW [mm]	Diametro del cavo cable diameter Min/Max [mm]	Dimensioni Sizes [mm]		Confezione Packaging [pz]	Nota Note
				H	L		
PCM501_M012X010	M12x1,5	15	3,5÷5,0	22,0	10,0	50	(1)
PCM501_M012X020	M12x1,5	15	5,0÷6,5	22,0	10,0	50	(1)
PCM501_M016X010	M16x1,5	18	6,0÷10,5	25,0	10,0	50	(1)
PCM501_M020X010	M20x1,5	24	8,0÷15,0	27,0	10,0	50	(1)
PCM501_M025X010	M25x1,5	30	12,5÷20,5	33,0	11,0	25	(1)
PCM501_M032X010	M32x1,5	36	17,0÷25,5	33,0	13,0	25	(1)
PCM501_M040X010	M40x1,5	46	24,0÷33,0	38,0	13,0	10	(1)
PCM501_M050X010	M50x1,5	55	33,0÷42,0	42,0	14,0	10	(1)
PCM501_M063X010	M63x1,5	70	40,0÷52,0	42,0	14,0	5	(1)

(1) Certificato c(UR)us / c(UR)us certified

Ghiera con elementi di incisione - Lock nut with cutter teeth

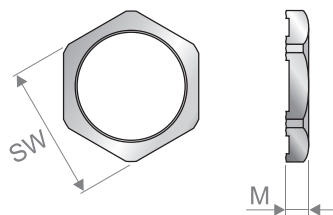

Codice Code	Filetto Thread	Chiave di serraggio Tightening key SW [mm]	Dimensioni Sizes [mm]		Confezione Packaging [pz]
			M		
PCFM50_M012	M12x1,5	15	3,5		25
PCFM50_M016	M16x1,5	19	3,5		25
PCFM50_M020	M20x1,5	24	4,0		25
PCFM50_M025	M25x1,5	30	4,0		10
PCFM50_M032	M32x1,5	36	5,0		10
PCFM50_M040	M40x1,5	46	5,3		10
PCFM50_M050	M50x1,5	55	6,3		10
PCFM50_M063	M63x1,5	70	7,0		10
PCFM50_P007	Pg 7	15	3,3		25
PCFM50_P009	Pg 9	18	3,3		25
PCFM50_P011	Pg 11	21	3,5		25
PCFM50_P013	Pg 13	24	3,5		25
PCFM50_P016	Pg 16	26	3,5		25
PCFM50_P021	Pg 21	32	4,0		10
PCFM50_P029	Pg 29	41	4,6		10
PCFM50_P036	Pg 36	50	5,8		10
PCFM50_P042	Pg 42	60	5,8		10
PCFM50_P048	Pg 48	64	6,5		10

Composizione del codice - Code composition

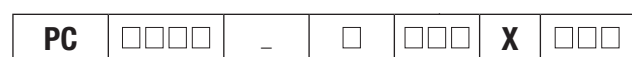

Famiglia
Family

Codice identificativo della famiglia di pressacavi.
Code depending on the glands' family.

Versione Version	Inserire To be interted
Metric	M

Filetto Thread	Inserire To be interted
M12, M16, ..., M32	012, 016, ..., 032

Range di diametri
Diameter range

Codice identificativo del range di diametri di accoppiamento.
Code depending on the cable range.

Ghiera - Lock nut



Famiglia
Family

Codice identificativo della famiglia di ghiera.
Code depending on the lock nuts' family.

Versione Version	Inserire To be interted
Metric	M
PG	P

Filetto Thread	Inserire To be interted
M12, M16, ..., M63	012, 016, ..., 063
Pg 7, Pg 9, ..., Pg 48	007, 009, ..., 048

Pressacavi metallici ultra piatti ad alte prestazioni



High-performing ultra-flat metallic cable glands

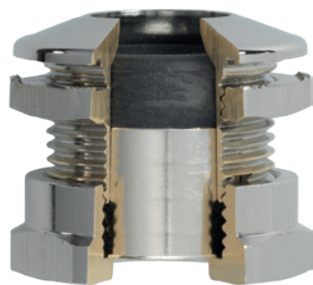

Impiego - Use

I pressacavi ultra piatti impediscono qualunque manomissione dall'esterno non avendo alcuna superficie di contatto per poter agire con le mani o con un utensile. I pressacavi ultra-piatti vengono utilizzati quando è richiesto un elevato livello di design oppure, grazie alla loro ridotta superficie di contaminazione e la facilità di pulizia, sono utilizzati per le camere bianche ed in applicazioni del settore food and beverage. I pressacavi ultra piatti sono certificati EHEDG (European Hygienic Engineering & Design Group), un consorzio costituito da produttori di macchine, operatori dell'industria del food and beverage, istituti di ricerca e enti di controllo per la salute pubblica. L'anello di tenuta ha una buona resistenza chimica e garantisce una classe di protezione fino a IP 68 (10 bar) e IP 69K.

The ultra-flat cable glands inhibit any manipulation from the outside; no contact surface for interference neither by hand or with a tool will be found. The ultra-flat cable glands are used for design applications and, thanks to their very little surface for contamination and their good cleanability, they are used for cleanroom and food and beverage applications. The ultra-flat cable glands are certified EHEDG (European Hygienic Engineering & Design Group), a consortium of equipment manufacturers, food industries, research institutes and public health authorities promoting "safe food" by improving hygienic engineering and design in all aspects of food manufacture. The elastic sealing rings have a good chemical resistance and they provide a reliable seal with a guaranteed IP 68 (10 bar) and IP 69K protection classes.

Dati tecnici - Technical data

Caratteristica - Characteristics	Valore/proprietà - Value/property
Materiale <i>Material</i>	Ottone nichelato o Acciaio inossidabile A2 (parte frontale) <i>Nickel-plated brass or Stainless steel A2 (front part)</i>
Materiale dell'anello di tenuta <i>Sealing ring material</i>	TPE o FKM (per versione in acciaio inossidabile), elemento singolo <i>TPE or FKM (for stainless steel version), one-piece.</i>
Materiale della guarnizione <i>Material of the sealing washer</i>	FPM o FKM (per versione in acciaio inossidabile), elemento singolo <i>FPM or FKM (for stainless steel version), one-piece.</i>
Temperatura di esercizio <i>Temperature range</i>	-40°C, +100°C fino a +200°C per versione in acciaio inossidabile <i>-40°C, +100°C up to +200°C for stainless steel version</i>
Grado di protezione <i>Protection class</i>	IP 68 (10 bar) IP 69K
Spessore della parete di installazione <i>Thickness of the installation wall</i>	Max. 5 mm

Nota. Versione in acciaio inossidabile certificata EHEDG
Note. EHEDG certification for stainless steel version

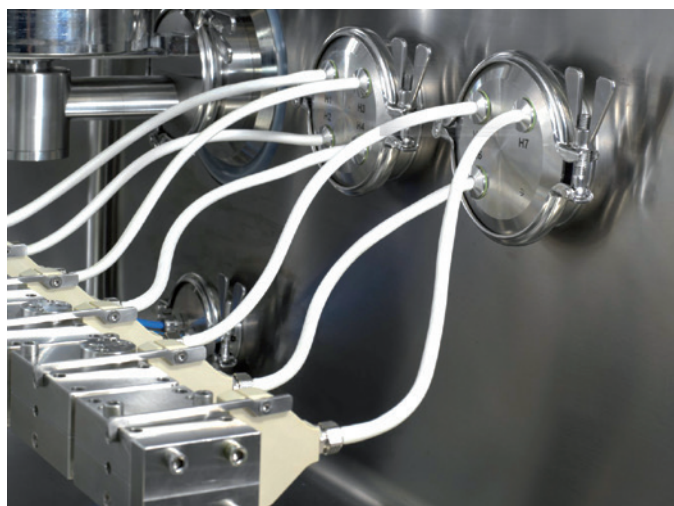

Codifiche e dimensioni - Coding and dimensions

Pressacavo dritto - Straight cable gland

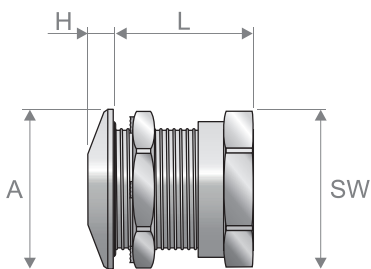

Codice Code	Versione Version	Filetto Thread	Chiave di serraggio Tightening key SW [mm]	Diametro del cavo cable diameter Min/Max [mm]	Dimensioni Sizes [mm]			Confezione Packaging [pz]	Nota Note
					ØA	H	L		
PCM301_M016X010	SS	M16x1,5	18	5,0÷6,5	22,0	4,0	21,0	25	(1)
PCM301_M016X020	SS	M16x1,5	18	6,5÷8,0	22,0	4,0	21,0	25	(1)
PCM301_M020X010	SS	M20x1,5	24	6,0÷8,0	27,0	4,5	23,0	25	(1)
PCM301_M020X020	SS	M20x1,5	24	8,0÷10,5	27,0	4,5	23,0	25	(1)
PCM301_M025X010	SS	M25x1,5	30	8,0÷11,0	32,0	5,5	25,0	20	(1)
PCM301_M025X020	SS	M25x1,5	30	11,0÷15,0	32,0	5,5	25,0	20	(1)
PCM301_M032X010	SS	M32x1,5	36	12,5÷16,0	39,0	6,0	28,0	10	(1)
PCM301_M032X020	SS	M32x1,5	36	16,0÷20,5	39,0	6,0	28,0	10	(1)
PCM300_M016X010	NPB	M16x1,5	18	5,0÷6,5	22,0	4,0	21,0	25	(2)
PCM300_M016X020	NPB	M16x1,5	18	6,5÷8,0	22,0	4,0	21,0	25	(2)
PCM300_M020X010	NPB	M20x1,5	24	6,0÷8,0	27,0	4,5	23,0	25	(2)
PCM300_M020X020	NPB	M20x1,5	24	8,0÷10,5	27,0	4,5	23,0	25	(2)
PCM300_M025X010	NPB	M25x1,5	30	8,0÷11,0	32,0	5,5	25,0	20	(2)
PCM300_M025X020	NPB	M25x1,5	30	11,0÷15,0	32,0	5,5	25,0	20	(2)
PCM300_M032X010	NPB	M32x1,5	36	12,5÷16,0	39,0	6,0	28,0	10	(2)
PCM300_M032X020	NPB	M32x1,5	36	16,0÷20,5	39,0	6,0	28,0	10	(2)

(1) Certificato EHEDG / EHEDG certified

(2) Non certificato EHEDG / Not EHEDG certified

Legenda materiali: SS = Acciaio inossidabile, NPB = Ottone nichelato

Materials' description: SS = Stainless steel, NPB = Nickel-plated brass

Composizione del codice - Code composition

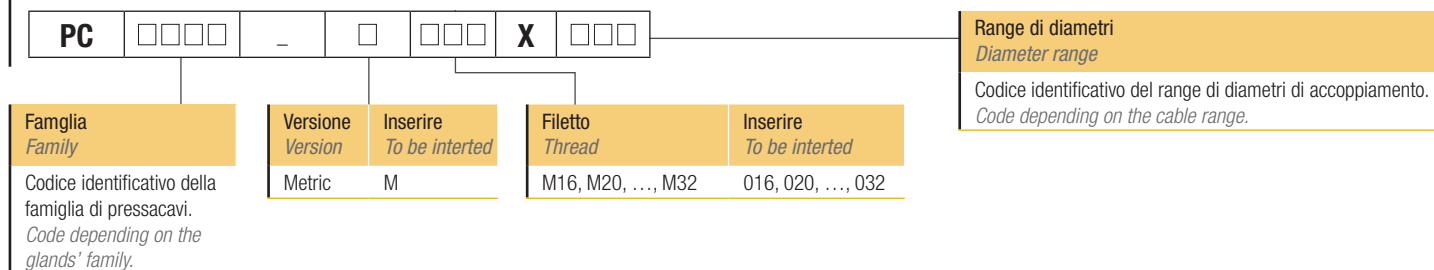

Bilanciatori di pressione a membrana



Pressure balance with membrane



Impiego - Use

Molti quadri elettrici, scatole di derivazione e alloggiamenti in generale sono generalmente protetti contro acqua e polvere (IP 68), ma non sono a tenuta di gas. Questo genera un ingresso di umidità che condensa se la temperatura scende sotto il punto di rugiada. L'acqua che si forma è spesso causa di corrosione e malfunzionamenti. Al fine di evitare elevati livelli di umidità e la formazione di condensa nell'alloggiamento, si deve sempre garantire l'equalizzazione della pressione tra interno ed esterno e il ricambio dell'aria. Gli elementi di bilanciamento della pressione installati all'interno di alloggiamenti elettrici ed elettronici prevengono le differenze di pressione, le variazioni di temperatura e la formazione di condensa. Due elementi installati all'interno dello stesso alloggiamento in due posizioni opposte consentono una circolazione ottimale del flusso d'aria.

Many electro-technical housings are always protected against water and dust (IP 68) but are not gastight. This results in access by humidity which condenses if below the dew point line. The water which is present often leads to corrosion and malfunctions. In order to prevent differences in pressure, high levels of humidity and the formation of condensation in the housing, there must always be constant pressure equalization and air exchange. The pressure balance and drainage elements in electrical and electronics housings prevent pressure differences, temperature variations and formation of condensation. Two opposite elements installed in the same housing allow for optimal circulation of air.

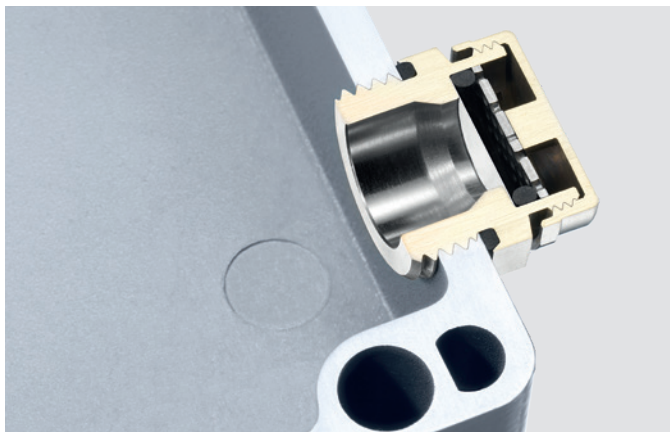

Dati tecnici - Technical data

Caratteristica - Characteristics	Valore/proprietà - Value/property
Materiale <i>Material</i>	Poliammide PA 6 (versione in plastica) e ottone nichelato (versioni in metallo) <i>Polyamide PA 6 (plastic version) and nickel-plated brass (metallic versions)</i>
Materiale della membrana <i>Membrane material</i>	PES (polietereossulfone) <i>PES (polyethersulfone)</i>
Materiale dell'o-ring <i>O-ring material</i>	NBR
Temperatura di esercizio <i>Temperature range</i>	-40°C, +100°C (versione in plastica / plastic version) -40°C, +110°C (versione in metallo / metallic version)
Grado di protezione <i>Protection class</i>	IP 66, IP 68, IP 69K
Pressione di ingresso dell'acqua <i>Water intrusion pressure</i>	> 12.0 psi / 0.83 bar
Portata del flusso d'aria <i>Air flow rate</i>	> 90 ml/min/cm ² @ 10 mbar



Codifiche e dimensioni - Coding and dimensions

Bilanciatore di pressione in materiale plastico - Plastic pressure balance

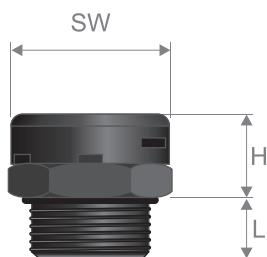

Codice <i>Code</i>	Filetto <i>Thread</i>	Chiave di serraggio <i>Tightening key</i> SW [mm]	Dimensioni <i>Sizes [mm]</i>		Confezione <i>Packaging [pz]</i>
			H	L	
PCSPB1_M012NE	M12x1,5	17	9,0	10,0	25

Bilanciatore di pressione in materiale metallico - Metallic pressure balance

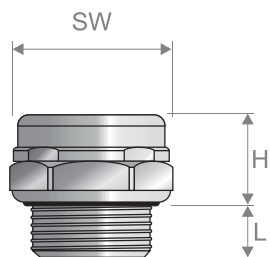

Codice Code	Filetto Thread	Chiave di serraggio Tightening key SW [mm]	Dimensioni Sizes [mm]		Confezione Packaging [pz]
			H	L	
PCSMB1_M012	M12x1,5	18	9,5	8,0	25
PCSMB1_M016	M16x1,5	18	9,5	8,0	20
PCSMB1_M020	M20x1,5	22	10,0	8,0	20
PCSMB1_P007	Pg 7	18	9,5	8,0	25
PCSMB1_P011	Pg 11	22	10,0	8,0	20

Bilanciatori di pressione con filtro sinterizzato



Pressure balance with sintered filter



Impiego - Use

Molti alloggiamenti elettrici ed elettronici sono generalmente protetti contro acqua e polvere (IP 68), ma non sono a tenuta di gas. Questo genera un ingresso di umidità che condensa se la temperatura scende sotto il punto di rugiada. L'acqua che si forma è spesso causa di corrosione e malfunzionamenti. Al fine di evitare elevati livelli di umidità e la formazione di condensa nell'alloggiamento, si deve sempre garantire l'equalizzazione della pressione tra interno ed esterno e il ricambio dell'aria. Gli elementi di bilanciamento della pressione installati all'interno di alloggiamenti elettrici ed elettronici previene le differenze di pressione, le variazioni di temperatura e la formazione di condensa. Gli elementi a filtro sinterizzato permettono flussi d'aria più elevati rispetto agli elementi a membrana e possono anche essere usati come elementi di drenaggio. Due elementi installati all'interno dello stesso alloggiamento in due posizioni opposte consentono una circolazione ottimale del flusso d'aria.

Many electro-technical housings are always protected against water and dust (IP 68) but are not gastight. This results in access by humidity which condenses if below the dew point line. The water which is present often leads to corrosion and malfunctions. In order to prevent differences in pressure, high levels of humidity and the formation of condensation in the housing, there must always be constant pressure equalization and air exchange. The pressure balance and drainage elements in electrical and electronics housings prevent pressure differences, temperature variations and formation of condensation. Pressure balance elements with sinter filter allow for bigger air exchange rates in respect to the pressure balance elements with membrane and may also be used for drainage. Two opposite elements installed in the same housing allow for optimal circulation of air.

Dati tecnici - Technical data

Caratteristica - Characteristics	Valore/proprietà - Value/property
Materiale <i>Material</i>	Ottone nichelato <i>Nickel-plated brass</i>
Materiale del filtro <i>Filter disc material</i>	Bronzo sinterizzato <i>Sintered bronze</i>
Materiale dell'o-ring <i>O-ring material</i>	NBR
Temperatura di esercizio <i>Temperature range</i>	-50°C, +110°C
Grado di protezione <i>Protection class</i>	IP 54, IP x9K
Grado di filtrazione <i>Filter degree</i>	40 µm

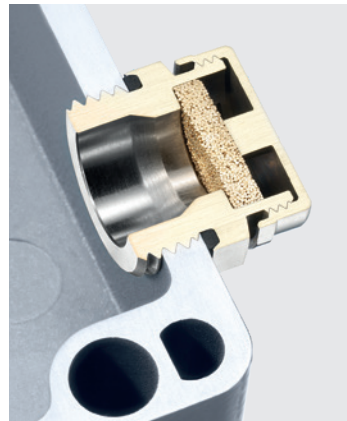

Codifiche e dimensioni - Coding and dimensions

Bilanciatore di pressione in materiale metallico - Metallic pressure balance

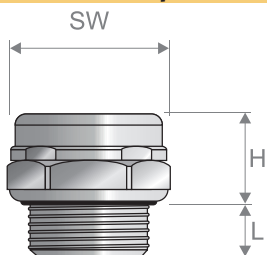

Codice <i>Code</i>	Filetto <i>Thread</i>	Chiave di serraggio <i>Tightening key</i> SW [mm]	Dimensioni <i>Sizes [mm]</i>		Confezione <i>Packaging [pz]</i>
			H	L	
PC SMB2_M012	M12x1,5	18	9,5	8,0	25
PC SMB2_M016	M16x1,5	18	9,5	8,0	20
PC SMB2_M020	M20x1,5	22	10,0	8,0	20
PC SMB2_PO07	Pg 7	18	9,5	8,0	25
PC SMB2_PO11	Pg 11	22	10,0	8,0	20



Elemento di drenaggio

Drainage element



Impiego - Use

Molti alloggiamenti elettrici ed elettronici sono generalmente protetti contro acqua e polvere (IP 68), ma non sono a tenuta di gas. Questo genera un ingresso di umidità che condensa se la temperatura scende sotto il punto di rugiada. L'acqua che si forma è spesso causa di corrosione e malfunzionamenti.

Al fine di evitare elevati livelli di umidità e la formazione di condensa nell'alloggiamento, si deve sempre garantire l'equalizzazione della pressione tra interno ed esterno e il ricambio dell'aria. Gli elementi di bilanciamento della pressione installati all'interno di alloggiamenti elettrici ed elettronici previene le differenze di pressione, le variazioni di temperatura e la formazione di condensa.

Gli elementi di drenaggio sono progettati per drenare rapidamente elevate quantità di acqua. Nel caso di alloggiamenti a pareti sottili è necessario l'uso della apposite ghiera di drenaggio.

Many electro-technical housings are always protected against water and dust (IP 68) but are not gastight. This results in access by humidity which condenses if below the dew point line. The water which is present often leads to corrosion and malfunctions. In order to prevent differences in pressure, high levels of humidity and the formation of condensation in the housing, there must always be constant pressure equalization and air exchange.

The pressure balance and drainage elements in electrical and electronics housings prevent pressure differences, temperature variations and formation of condensation. Drainage elements are designed to allow bigger quantities of water to drain away quickly. In case of thin-walled housings, drainage lock nut are required.

Dati tecnici - Technical data

Caratteristica - Characteristics	Valore/proprietà - Value/property
Materiale <i>Material</i>	Ottone nichelato <i>Nickel-plated brass</i>
Materiale del filtro <i>Filter disc material</i>	Acciaio inossidabile A2 <i>Stainless steel A2</i>
Materiale dell'o-ring <i>O-ring material</i>	NBR
Temperatura di esercizio <i>Temperature range</i>	-50°C, +110°C
Grado di protezione <i>Protection class</i>	IP 4x

Codifiche e dimensioni - Coding and dimensions

Elemento di drenaggio - Drainage element

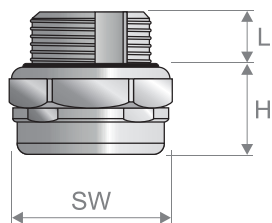

Codice <i>Code</i>	Filetto <i>Thread</i>	Chiave di serraggio <i>Tightening key</i> SW [mm]	Dimensioni <i>Sizes [mm]</i>		Confezione <i>Packaging [pz]</i>
			H	L	
PCSM1_M012	M12x1,5	18	9,5	10,0	25
PCSM1_M016	M16x1,5	18	9,5	10,0	20
PCSM1_M020	M20x1,5	22	10,0	10,0	20

Ghiera per elemento di drenaggio - Lock nut for drainage element

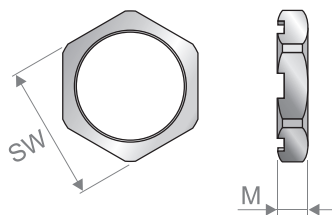

Codice Code	Filetto Thread	Chiave di serraggio Tightening key SW [mm]	Dimensioni Sizes [mm] M	Confezione Packaging [pz]
PCFMS1_M012	M12x1,5	15	4,5	25
PCFMS1_M016	M16x1,5	19	5,5	20
PCFMS1_M020	M20x1,5	24	5,5	20

Raccordi per cavi MC-HL e Teck 90-HL



Fittings for MC-HL and Teck90-HL cables

Cable Sealing Fittings for Use in Hazardous Locations – “UL/CSA Listed”



Impiego - Use

Questi raccordi sono utilizzati per raccordare cavi armati tipo MC-HL e Teck 90-HL e sono ideati per l'impiego in zone a pericolo di esplosione Class I, Division 1, Hazardous Locations. La loro costruzione rende possibile la messa a terra dell'armatura del cavo e l'installazione sia in posa verticale che orizzontale. Vengono forniti completi di resina di tenuta (sealing compound).

These fittings are used to connect type MC-HL and Teck 90-HL armored cables and are suitable for use in locations Class I, Division 1, Hazardous Locations. Their construction permits the earthing of the cable armor and either vertical and horizontal installation. They are supplied complete with sealing compound.

Dati tecnici - Technical data

Caratteristica - Characteristics	Valore/proprietà - Value/property
Materiale <i>Material</i>	Alluminio (prodotto standard) o ottone <i>Aluminum (as standard product) or brass</i>
Messa a terra <i>Grounding continuity</i>	Molla in acciaio inox rivestita in rame per la messa a terra dell'armatura (per cavi MC) <i>Stainless steel copper-plated spring provides grounding continuity of cable armour (MC cables)</i>
Tipo di tenuta <i>Sealing type</i>	A prova di esplosione, tenuta mediante resina sui conduttori e mediante guarnizione a tenuta stagna sulla guaina esterna. <i>Explosion proof, compound sealing on conductors and watertight seal on outer sheath of cable.</i>
Temperatura di esercizio <i>Temperature range</i>	-25°C, +60°C
Grado di protezione <i>Protection class</i>	NEMA 4, IP 56

Codifiche e dimensioni - Coding and dimensions

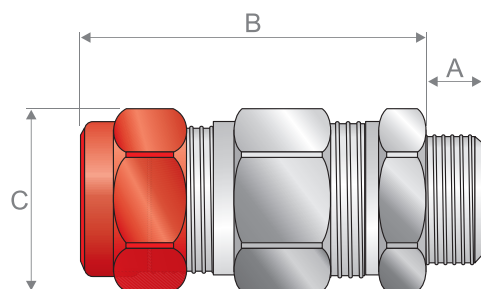

Codice <i>Code</i>	Versione <i>Version</i>	Filetto <i>Thread</i>	Dimensioni <i>Dimensions [mm]</i>			Diametro esterno min/max armatura <i>Min/max external armor diameter</i>		Diametro min/max guaina <i>Min/max jacket diameter</i>		Quantità di resina <i>Quantity of resin [g]</i>
			A	B	C	[inch]	[mm]	[inch]	[mm]	
ANTMCX050□□	NPT	1/2"	19,1	66,7	34,9	0,440÷0,650	11,2÷16,5	0,490÷0,781	12,4÷19,8	7
ANTMCX075□□	NPT	3/4"	19,8	73,0	41,3	0,600÷0,850	15,2÷21,6	0,650÷1,000	16,5÷25,4	14
ANTMCX100□□	NPT	1"	23,8	79,4	50,8	0,800÷1,120	20,3÷28,4	0,850÷1,313	21,6÷33,4	20
ANTMCX125□□	NPT	1"1/4	24,6	79,4	61,9	1,100÷1,400	27,9÷35,6	1,150÷1,625	29,2÷41,3	43
ANTMCX150□□	NPT	1"1/2	24,6	85,7	69,9	1,330÷1,610	33,8÷40,9	1,380÷1,781	35,1÷45,2	52
ANTMCX200□□	NPT	2"	25,4	135,0	88,9	1,570÷2,060	39,9÷52,3	1,630÷2,313	41,4÷58,8	128
ANTMCX250□□	NPT	2"1/2	36,5	154,0	101,6	1,930÷2,470	49,0÷62,7	1,990÷2,719	50,5÷69,1	245
ANTMCX300□□	NPT	3"	36,5	154,0	123,8	2,450÷3,020	62,2÷76,7	2,525÷3,281	64,1÷83,3	447
ANTMCX350□□	NPT	3"1/2	41,3	196,9	136,5	2,950÷3,520	74,9÷89,4	3,025÷3,781	76,8÷96,0	724
ANTMCX400□□	NPT	4"	41,3	211,2	149,2	3,500÷4,020	88,9÷102,1	3,585÷4,281	91,1÷108,7	1.104

Composizione del codice - Code composition

ANTMCX...



Materiale del raccordo <i>Fitting material</i>	Inserire <i>To be inserted</i>
Alluminio <i>Aluminium</i>	A
Ottone <i>Brass</i>	NB

Montaggio - Mounting

I raccordi per cavi MC-HL e Teck90-HL assicurano una tenuta ottimale grazie all'impiego di una resina sigillante che viene avvolta sul cordato e attorno ai singoli conduttori all'atto dell'installazione. L'ancoraggio del raccordo sull'armatura è realizzato a mezzo di un anello metallico che la blocca meccanicamente mentre la tenuta sulla guaina esterna del cavo avviene mediante una guarnizione posta all'interno della ghiera. La tabella che segue è un crossreference che consente di individuare il codice del raccordo in relazione alla tipologia del cavo da impiegare.

Fittings for MC-HL and Teck90-HL cables guarantee an optimal sealing thanks to a sealing resin which is wound round the cord and round the single conductors during the installation. The anchoring of the fitting to the armor is carried out by means of a metal ring which blocks it mechanically, while the sealing on the external jacket of the cable is obtained through a seal inside the gland nut. The following table is a cross-reference permitting to find out the code of the fitting according to the type of cable to be used.

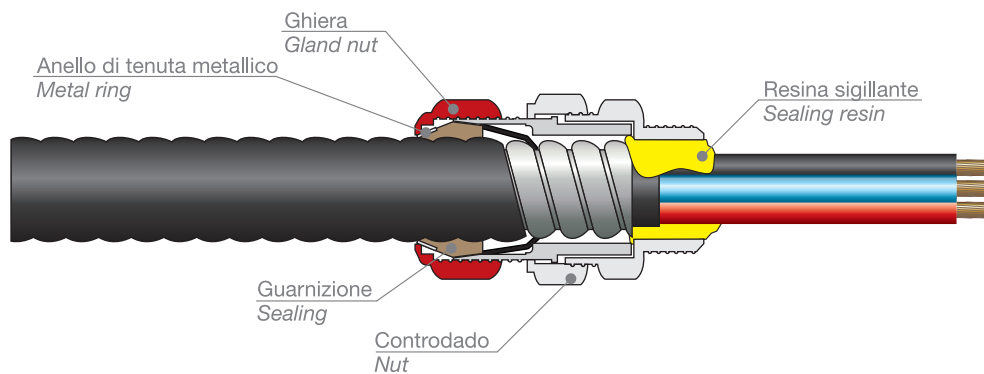

Sistemi passacavo preconfigurati

Preconfigured cable entry systems

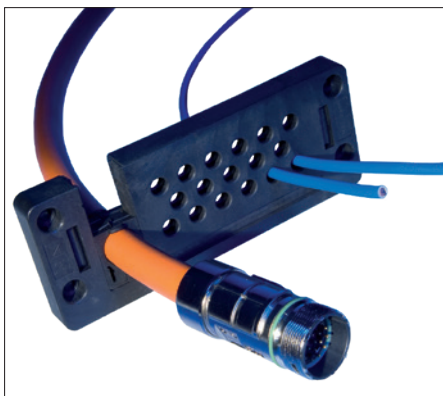
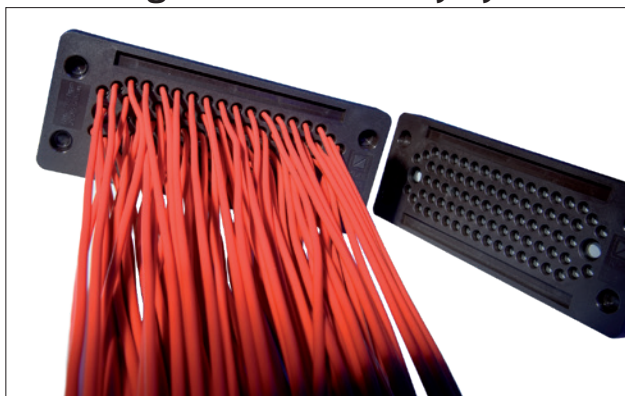

Impiego - Use

Sono sistemi passacavi preconfigurati che consentono un montaggio estremamente rapido di cavi, guaine di protezione e tubi per aria compressa. Possono essere applicati ai quadri anche senza l'uso di viti mediante degli speciali ganci ad uncino e permettono di ottenere un risparmio di spazio eccezionale. Alcuni modelli sono realizzati in modo da accogliere fino a due elementi passacavo che consentono di installare fino a quattro cavi preassemblati. Sono una reale alternativa ai pressacavi tradizionali.

The preconfigured cable entry systems allow quicker mounting of cables, electric conduits and pneumatic hoses. They can be installed also without screws using the special catch hooks and they allow to save a lot of space. Some of the models take up to four preassembled cable in two grommets. They are a real alternative to standard cable fittings.



I sistemi passacavo preconfigurati consentono di risparmiare fino al 50% di spazio di installazione e sono 10 volte più veloci da montare rispetto ai tradizionali pressacavi plastici o metallici; vengono semplicemente ancorati nella spaccatura realizzata nella parete del quadro ed i cavi possono essere immediatamente cablati attraverso le apposite aperture. I vantaggi sono notevoli:

- riduzione del tempo di installazione,
- riduzione dello spazio di installazione,
- alta densità di cablaggio,
- nessuna necessità di attrezzi particolari,
- alto grado di protezione,
- nessun attorcigliamento di cavi e tubi.

Preconfigured cable entry systems are 10 times faster and with a space saving of up to 50% compared with conventional cable glands. The preconfigured cable entry systems are simply clicked into the cut-outs and the cables are then pushed through. The preconfigured cable entry systems allow:

- enormous time savings during assembly,
- extremely low space requirement,
- high packing density,
- assembly without tools,
- high protection class,
- no kinks in cables and tubes.

Dati tecnici - Technical data

Caratteristica - Characteristics	Valore/proprietà - Value/property	Riferimenti - Remarks
Materiale <i>Material</i>	Poliamide 6.6 <i>Polyamide 6.6</i>	-
Materiale delle guarnizioni <i>Seal material</i>	TPU/NBR/EPDM	-
Temperatura di esercizio <i>Temperature range</i>	-30°C, +70°C	-
Classe di autoestinguenza <i>Flammability rating</i>	V0	UL 94
Grado di protezione <i>Protection class</i>	IP65 (codici/codes RPPLTA...) IP54 (codici/codes RPPLTB...)	-
Colore <i>Color</i>	Nero <i>Black</i>	-

Codifiche e dimensioni - Coding and dimensions

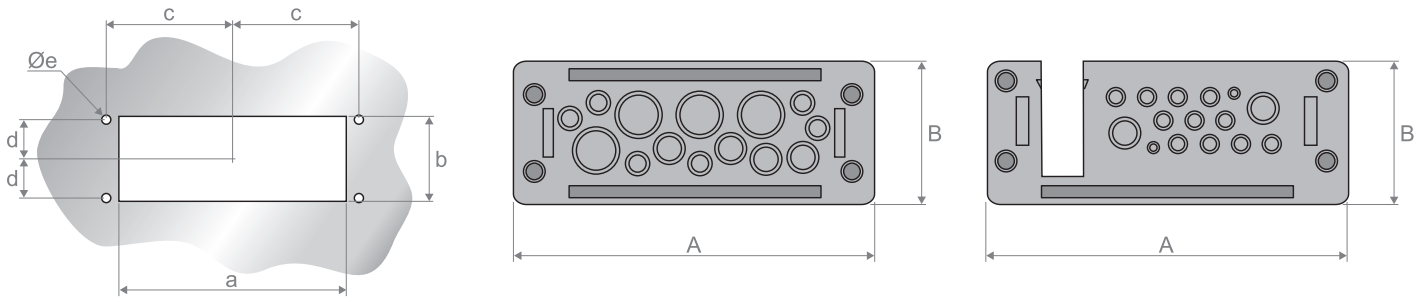

RPPLTA24.11



RPPLTA24.12



RPPLTA24.13



RPPLTA24.14



RPPLTA24.17



RPPLTA24.17-1



RPPLTA24.22



RPPLTA24.23



RPPLTA24.29



RPPLTA24.80



RPPLTB24.10.02



RPPLTB24.14.02

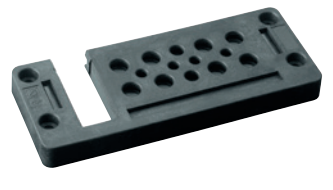

RPPLTB24.15.02



RPPLTB24.17.02



RPPLTB24.20.02



RPPLTB24.21.02



Codice Code	Numero di elementi passacavo ⁽¹⁾ No. of grommets ⁽¹⁾	Numero di aperture x diametro No. openings x diameter [mm]	Sporgenza Thickness [mm]	Dimensioni Sizes [mm]						Confezione Packaging [pz]	
				A	B	a	b	c	d		e
RPPLTA24.11	0	4 x (3÷6,5 mm) 4 x (5÷9,2 mm) 3 x (14÷20 mm)	15	147,0	59,0	112,0	36,0	65,0	16,0	5,5	1
RPPLTA24.12	0	12 x (8÷12 mm)	15	147,0	59,0	112,0	36,0	65,0	16,0	5,5	1
RPPLTA24.13	0	2 x (3÷5,5 mm) 6 x (4,1÷8,1 mm) 4 x (9÷14 mm) 1 x (14÷20 mm)	15	147,0	59,0	112,0	36,0	65,0	16,0	5,5	1
RPPLTA24.14	0	6 x (3÷6,5 mm) 4 x (5÷9,2 mm) 4 x (9,6÷15,9 mm)	15	147,0	59,0	112,0	36,0	65,0	16,0	5,5	1
RPPLTA24.17	0	17 x (5÷9,2 mm)	15	147,0	59,0	112,0	36,0	65,0	16,0	5,5	1
RPPLTA24.17-1	0	11 x (3÷6,5 mm) 1 x (4,1÷8,1 mm) 5 x (8÷12,5 mm)	15	147,0	59,0	112,0	36,0	65,0	16,0	5,5	1
RPPLTA24.22	0	16 x (3÷6,5 mm) 4 x (5÷9,2 mm) 2 x (8÷12,5 mm)	15	147,0	59,0	112,0	36,0	65,0	16,0	5,5	1
RPPLTA24.23	0	23 x (4,1÷8,1 mm)	15	147,0	59,0	112,0	36,0	65,0	16,0	5,5	1
RPPLTA24.29	0	29 x (3÷6,5 mm)	15	147,0	59,0	112,0	36,0	65,0	16,0	5,5	1
RPPLTA24.80	0	78 x (1,5÷2,6 mm) 2 x (2,5÷5 mm)	15	147,0	59,0	112,0	36,0	65,0	16,0	5,5	1
RPPLTB24.10.02	2 piccoli- <i>small</i>	4 x (3÷6,5 mm) 2 x (4,5÷8,5 mm) 4 x (8÷12,5 mm)	15	146,0	58,0	112,0	36,0	65,0	16,0	5,5	1
RPPLTB24.14.02	2 piccoli- <i>small</i>	4 x (2,5÷5 mm) 2 x (3÷6,5 mm) 8 x (4,5÷8,5 mm)	15	146,0	58,0	112,0	36,0	65,0	16,0	5,5	1
RPPLTB24.15.02	2 piccoli- <i>small</i>	2 x (1,5÷3,5 mm) 11 x (3÷6,5 mm) 2 x (8,5÷12,5 mm)	15	146,0	58,0	112,0	36,0	65,0	16,0	5,5	1
RPPLTB24.17.02	2 piccoli- <i>small</i>	17 x (3÷6,5 mm)	15	146,0	58,0	112,0	36,0	65,0	16,0	5,5	1
RPPLTB24.20.02	2 piccoli- <i>small</i>	4 x (1,5÷3,5 mm) 6 x (3÷5 mm) 10 x (3÷6,5 mm)	15	146,0	58,0	112,0	36,0	65,0	16,0	5,5	1
RPPLTB24.21.02	2 piccoli- <i>small</i>	21 x (2,5÷5 mm)	15	146,0	58,0	112,0	36,0	65,0	16,0	5,5	1

(1) Gli elementi passacavo ed i relativi codici possono essere individuati più avanti nella sezione "Elementi per sistemi passacavi"

(1) The grommets and their codes can be selected hereinafter in the chapter "Grommets for cable entry systems"

Ganci ad uncino - Catch hooks

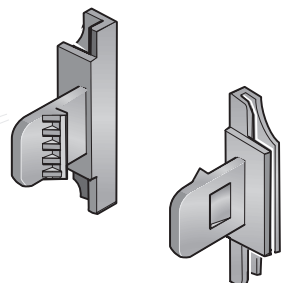

Codice gancio ad uncino Code of the catch hooks	Spessore lamiera quadro Plate thickness [mm]	Confezione Packaging [pz]
RPHKS010	1,5÷2,0	10
RPHKS020	2,1÷2,7	10
RPHKS030	2,8÷3,4	10
RPHKS040	3,5÷4,1	10

Montaggio - Mounting

Montaggio senza viti (modelli senza elementi passacavo) - Snap-on mounting (models without grommets)

1. Realizzare lo spacco nella parete del quadro rispettando le dimensioni richieste (vedi sezione "Codifica e dimensioni"). Inserire il sistema passacavo e premere fino ad agganciarlo saldamente.

1. Create a cut-out as shown in the drawings (see "Codes and dimensions"). Insert the cable entry system and press on until it clicks into place.

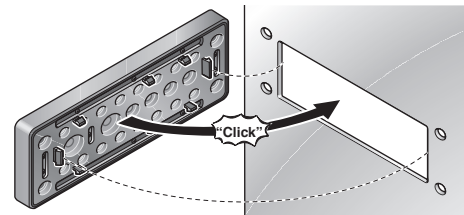

2. Dove necessario, rimuovere i tappi neri spingendo dal retro.

2. Where necessary, remove the black cover pressing from the rear until the cover falls out.

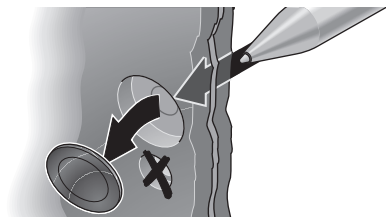

3. Scegliere una apertura adatta alla dimensione del cavo e spingere il cavo all'interno agendo dalla parte frontale. Tirare il cavo per la lunghezza desiderata.

3. Select an opening appropriate for the cable diameter and push the cable through the opening from the front. Pull the cable through to desired length.

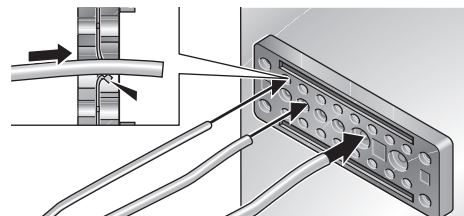

4. Estrarre il cavo per circa 10÷15 mm fino a che l'indicatore, prima visibile sul retro, scompare. L'indicatore potrà essere visibile nella parte frontale in relazione con le dimensioni del cavo.

4. Retract cable approx. 10÷15 mm until the indicator on the rear is no longer visible. Depending on cable diameter and insertion size, the indicator may become visible on the front side.

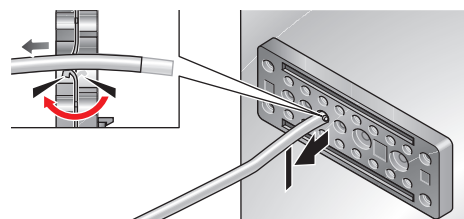

5. Se richiesto applicare le targhette identificative opzionali.

5. If required, position the optional label plate and click in.

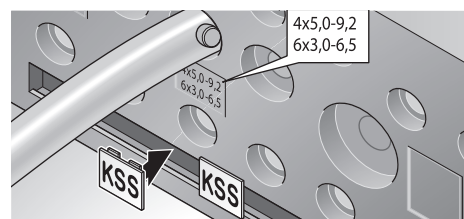

Montaggio senza viti (modelli con elementi passacavo) - Snap-on mounting (models with grommets)

1. Realizzare lo spacco nella parete del quadro rispettando le dimensioni richieste (vedi sezione "Codifica e dimensioni"). Montare i ganci ad uncino alle estremità dello spacco.

1. Create a cut-out as shown in the drawings (see "Codes and dimensions"). Set catch hooks into the sides of the cut-out.

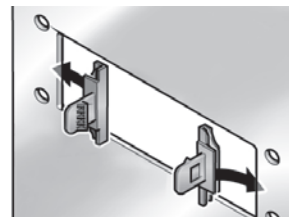

2. Posare il cavo nell'apposito elemento passacavo.

2. Lay the cable into the appropriate grommet.

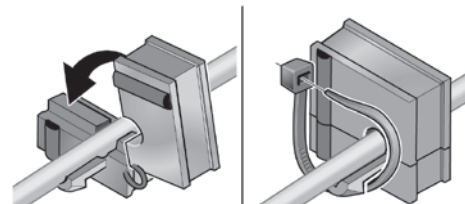

3. Aprire le asole alle estremità della cornice.

3. Punch through cover on cable entry system.

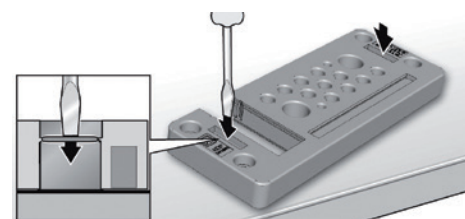

4. Montare gli elementi passacavo verificando che la lunghezza del cavo sia sufficiente.

4. Install all grommets and make sure there is enough cable length.

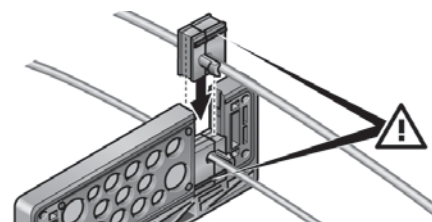

5. Scegliere una apertura adatta alla dimensione del cavo e spingere il cavo all'interno agendo dalla parte frontale. Tirare il cavo per la lunghezza desiderata. Estrarre quindi il cavo per circa 10÷15 mm fino a che l'indicatore, prima visibile sul retro, scompare. L'indicatore potrà essere visibile nella parte frontale in relazione con le dimensioni del cavo.

5. Select an opening appropriate for the cable diameter and push the cable through the opening from the front. Pull the cable through to desired length. Then retract cable approx. 10÷15 mm until the indicator on the rear is no longer visible. Depending on cable diameter and insertion size, the indicator may become visible on the front side.

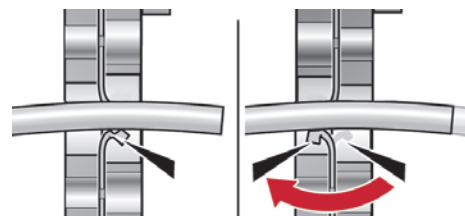

6. Inserire il sistema passacavo nei ganci ad uncino fino in battuta.

6. Insert the cable entry system onto the catch hooks and press on.

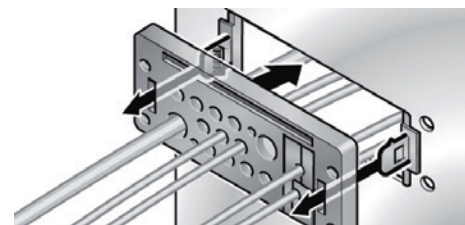

7. Bloccare i ganci ad uncino spingendo alle estremità del sistema passacavo.

7. Lock the catch hooks and press down the cable entry system at the ends again.

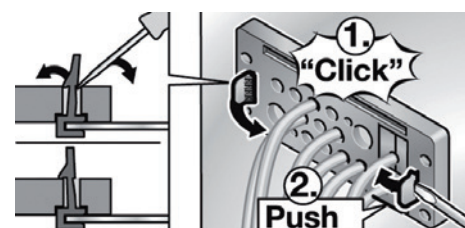

Montaggio con viti (modelli senza elementi passacavo) - Screw-on mounting (models without grommets)

1. Realizzare lo spacco nella parete del quadro rispettando le dimensioni richieste (vedi sezione "Codifica e dimensioni"). Aprire le asole di passaggio delle viti e montare il sistema mediante quattro viti.

1. Create a cut-out as shown in the drawings (see "Codes and dimensions"). Press through the membrane on the mounting holes on the cable entry system, set it onto the cut-out and screw down.

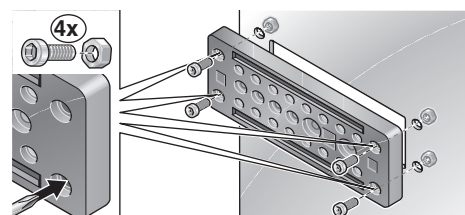

2. Dove necessario, rimuovere i tappi neri spingendo dal retro.

2. Where necessary, remove the black cover pressing from the rear until the cover falls out.

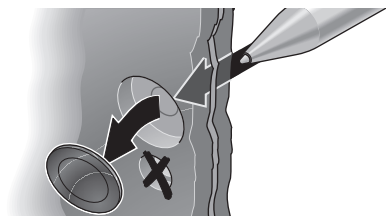

3. Scegliere una apertura adatta alla dimensione del cavo e spingere il cavo all'interno agendo dalla parte frontale. Tirare il cavo per la lunghezza desiderata.

3. Select an opening appropriate for the cable diameter and push the cable through the opening from the front. Pull the cable through to desired length.

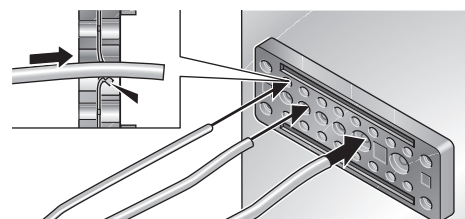

4. Estrarre il cavo per circa 10÷15 mm fino a che l'indicatore, prima visibile sul retro, scompare. L'indicatore potrà essere visibile nella parte frontale in relazione con le dimensioni del cavo.

4. Retract cable approx. 10÷15 mm until the indicator on the rear is no longer visible. Depending on cable diameter and insertion size, the indicator may become visible on the front side.

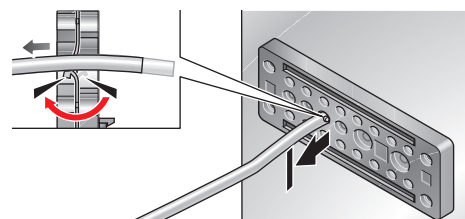

5. Se richiesto applicare le targhette identificative opzionali.

5. If required, position the optional label plate and click in.

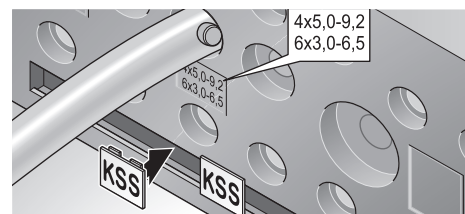

Montaggio con viti (modelli con elementi passacavo) - Screw-on mounting (models with grommets)

1. Realizzare lo spacco nella parete del quadro rispettando le dimensioni richieste (vedi sezione "Codifica e dimensioni").

1. Create a cut-out as shown in the drawings (see "Codes and dimensions").

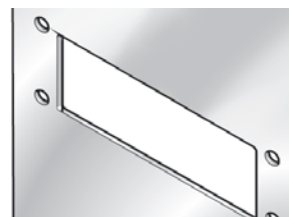

2. Posare il cavo nell'apposito elemento passacavo.

2. Lay the cable into the appropriate grommet.

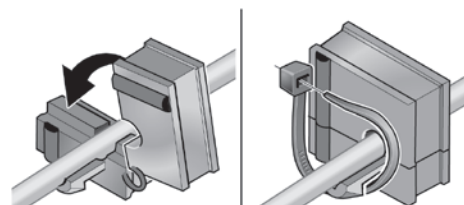

3. Aprire le asole di passaggio per le viti alle estremità della cornice.

3. Punch through cover on cable entry system.

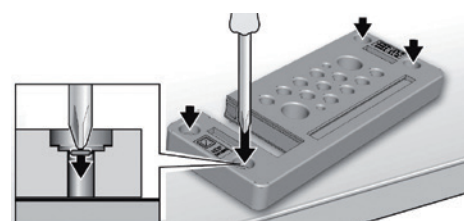

4. Montare gli elementi passacavo verificando che la lunghezza del cavo sia sufficiente.

4. Install all grommets and make sure there is enough cable length.

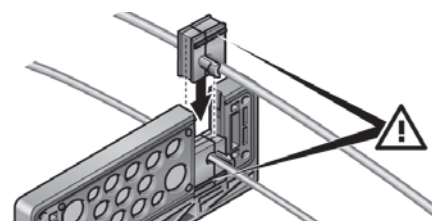

5. Scegliere una apertura adatta alla dimensione del cavo e spingere il cavo all'interno agendo dalla parte frontale. Tirare il cavo per la lunghezza desiderata. Estrarre quindi il cavo per circa 10÷15 mm fino a che l'indicatore, prima visibile sul retro, scompare. L'indicatore potrà essere visibile nella parte frontale in relazione con le dimensioni del cavo.

5. Select an opening appropriate for the cable diameter and push the cable through the opening from the front. Pull the cable through to desired length. Then retract cable approx. 10÷15 mm until the indicator on the rear is no longer visible. Depending on cable diameter and insertion size, the indicator may become visible on the front side.

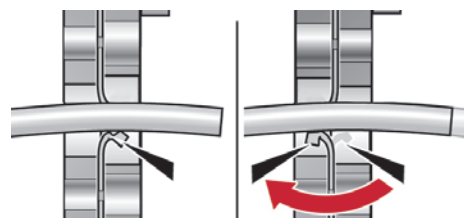

6. Posizionare ed avvitare il sistema passacavo.

6. Position and affix the cable entry plate above the cut-out.

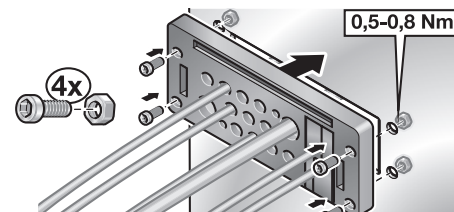

7. Premere le estremità del sistema passacavo.

7. Press down the cable entry system at the edges again

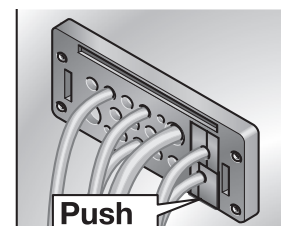

Sistemi passacavo componibili

Configurable cable entry systems

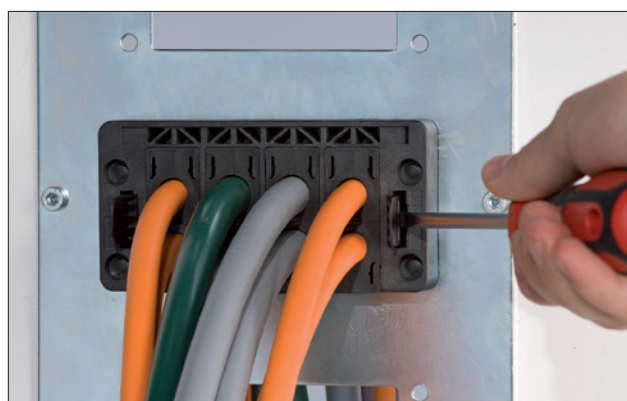

Impiego - Use

Questi sistemi sono costituiti da cornici e da relativi elementi passacavo che possono essere opportunamente composti in funzione delle applicazioni. I sistemi passacavo componibili consentono un montaggio estremamente rapido anche di cavi pre-assemblati e possono essere configurati secondo necessità utilizzando appositi elementi passacavo. Possono essere applicati ai quadri senza l'uso di viti bensì mediante degli speciali ganci ad uncino (forniti nella confezione per pareti di spessore 1,5÷2,0 mm). Gli elementi passacavo che si possono utilizzare sono di due tipologie, possono essere di tipo "piccolo" per cavi con diametro fino a 16 mm e di tipo "grande" per cavi con diametro fino a 31 mm.

These cable entry systems are made of bases and grommets that can be chosen accordingly the specific application. The cable entry systems allow quicker mounting also of pre-assembled cables and can be configured according to each specific need choosing the right available grommets. They can be installed without screws using the special catch hooks (included in the package for wall thickness of 1,5÷2,0 mm). The grommets are available in two sizes, the "small" ones are suitable for cable with diameter up to 16 mm and the "large" one are suitable for cable with diameter up to 31 mm.

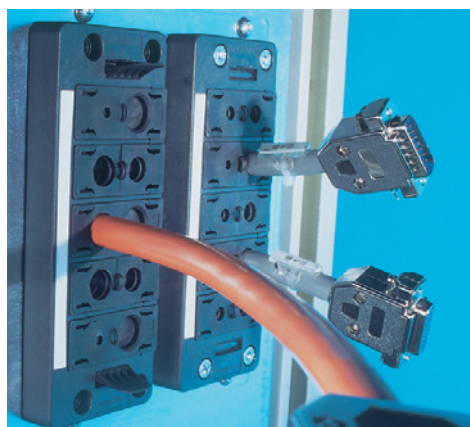

I sistemi passacavo componibili sono sistemi suddivisibili che risolvono i problemi di cablaggio di cavi connettorizzati. Connettori di grosse dimensioni possono essere introdotti nei quadri elettrici senza alcuna difficoltà. I ganci ad uncino forniti nella confezione consentono di accelerare i tempi di montaggio senza l'uso di particolari attrezzi. Diversi elementi passacavo consentono infine agli utenti di trovare la giusta soluzione per la loro applicazione.

- Inserimento dei cavi nei quadri senza interruzione.
- Montaggio semplice.
- Cornici realizzate in pezzo unico.
- Montaggio senza viti per lamiera da 1.5 fino a 4.1 mm.
- Buona resistenza a trazione.
- Elevata classe di protezione.

The configurable cable entry system is a split system that solves problems like introducing pre-assembled cables into enclosures. Larger plugs can also be introduced into enclosures without difficulty. The provided catch hooks significantly speed up mounting of the entire plate on the control cabinet. Different grommets allow users to choose the right solution for their application.

- Cable insertion without interruption.
- Simple mounting.
- Single-piece frame.
- Snap-in from 1.5 to 4.1 mm wall thickness and no need to screw on.
- Strain relief.
- High protection class.

Dati tecnici - Technical data

Caratteristica - Characteristics	Valore/proprietà - Value/property	Riferimenti - Remarks
Materiale Material	Poliammide 6.6 Polyamide 6.6	-
Temperatura di esercizio Temperature range	-40°C, +80°C (punte fino a 100°C) -40°C, +80°C (transient up to 100°C)	-
Classe di autoestinguenza Flammability rating	V0	UL 94
Grado di protezione Protection class	IP 54	-
Colore Color	Nero Black	-

Codifiche e dimensioni - Coding and dimensions

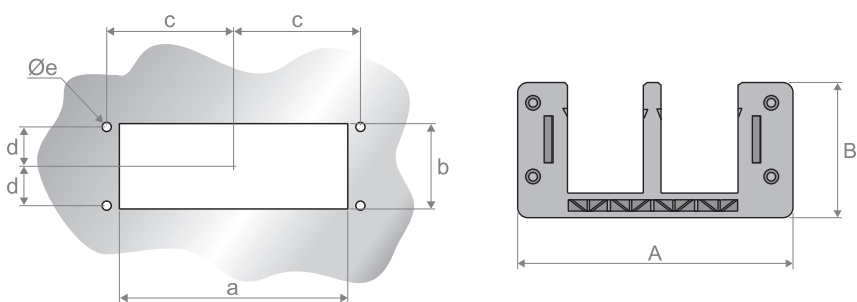

RPCRN16.02

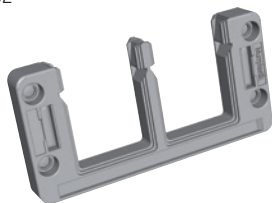

RPCRN16.05

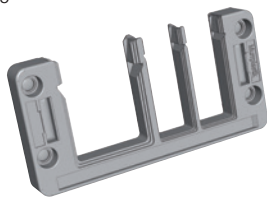

RPCRN16.08

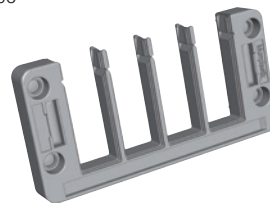

RPCRN24.04

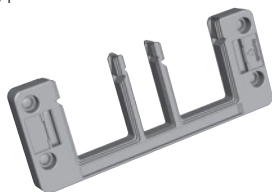

RPCRN24.07

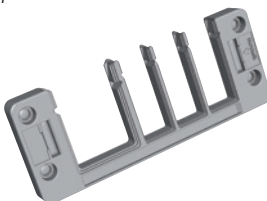

RPCRN24.10



Codice cornice ⁽¹⁾ Code of the base ⁽¹⁾	Numero di elementi passacavo ⁽¹⁾ No. of grommets ⁽¹⁾		Sporgenza Thickness [mm]	Dimensioni Sizes [mm]							Confezione Packaging [pz]
	"Piccoli" "Small"	"Grandi" "Large"		A	B	a	b	c	d	e	
RPCRN16.02	0	2	15,5	116,0	58,0	86,0	36,0	51,5	16,0	5,5	1
RPCRN16.05	4	1	15,5	116,0	58,0	86,0	36,0	51,5	16,0	5,5	1
RPCRN16.08	8	0	15,5	116,0	58,0	86,0	36,0	51,5	16,0	5,5	1
RPCRN24.04	2	2	15,5	146,0	58,0	112,0	36,0	65,0	16,0	5,5	1
RPCRN24.07	6	1	15,5	146,0	58,0	112,0	36,0	65,0	16,0	5,5	1
RPCRN24.10	10	0	15,5	146,0	58,0	112,0	36,0	65,0	16,0	5,5	1

(1) Gli elementi passacavo ed i relativi codici possono essere individuati più avanti nella sezione "Elementi per sistemi passacavo".

Nota. I ganci ad uncino per spessori 1,5÷2,0 mm sono forniti unitamente alle cornici, per spessori diversi fare riferimento alla tabella successiva.

(1) The grommets and their codes can be selected hereinafter in the chapter "Grommets for cable entry systems".

Note. The catch hooks for 1,5÷2,0 mm wall thickness are supplied with the base, catch hooks' codes for different wall thicknesses are in the table below.

Ganci ad uncino - Catch hooks

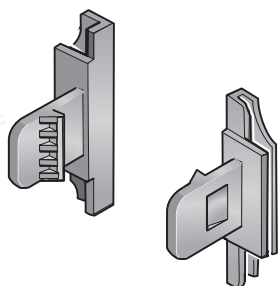

Codice gancio ad uncino Code of the catch hooks	Spessore lamiera quadro Plate thickness [mm]	Confezione Packaging [pz]
RPHKS010	1,5÷2,0	10
RPHKS020	2,1÷2,7	10
RPHKS030	2,8÷3,4	10
RPHKS040	3,5÷4,1	10

Montaggio - Mounting

Montaggio con ganci ad uncino - Snap-on mounting

1. Posare il cavo nell'apposito elemento passacavo.

1. Lay the cable into the appropriate grommet.

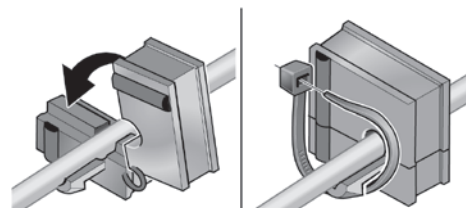

2. Aprire le asole alle estremità della cornice.

2. Punch through cover on base frame.

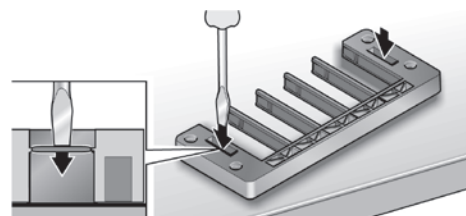

3. Realizzare lo spacco nella parete del quadro rispettando le dimensioni richieste (vedi sezione "Codifica e dimensioni"). Inserire i ganci ad uncino sui lati dello spacco.

3. Create a cut-out as shown in the drawings (see "Codes and dimensions"). Set the catch hooks into the sides of the cut-out.

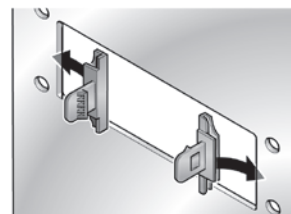

4. Montare gli elementi passacavo e inserire la cornice fino in battuta.

4. Install all grommets and insert the base onto the catch hooks and press on.

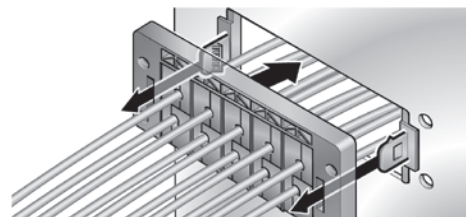

5. Bloccare i ganci ad uncino e premere leggermente gli elementi passacavo..

5. Lock the catch hooks with the base and press gently on the grommets.

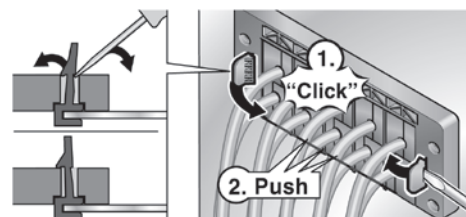

Montaggio con viti - Screw-on mounting

1. Posare il cavo nell'apposito elemento passacavo.

1. Lay the cable into the appropriate grommet.

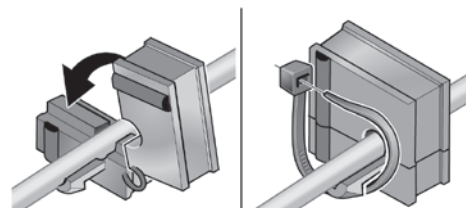

2. Aprire i fori per le viti alle estremità della cornice.

2. Punch through cover on base frame.

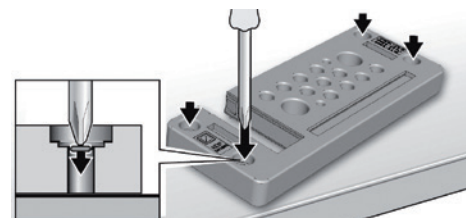

3. Realizzare lo spacco nella parete del quadro rispettando le dimensioni richieste (vedi sezione "Codifica e dimensioni"). Montare gli elementi passacavo e fissare la cornice con quattro viti.

3. Create a cut as shown in the drawings (see "Codes and dimensions"). Install all grommets and fix the base with 4 screws.

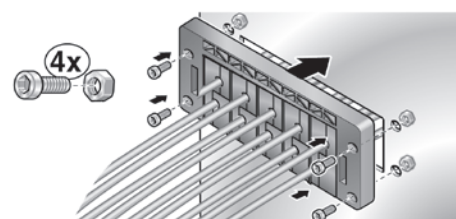

4. Premere leggermente gli elementi passacavo.

4. Press gently on the grommets.

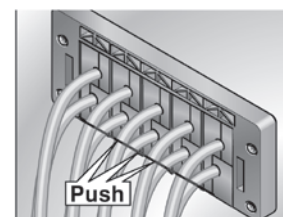

Elementi per sistemi passacavo

Grommets for cable entry systems



Impiego - Use

Sono elementi da utilizzare con i sistemi passacavo configurabili e preconfigurati. Gli elementi passacavo sono composti da due parti che vengono chiuse intorno al cavo e sono dotati di ganci che consentono di mantenerli in posizione all'interno dei sistemi passacavo. Utilizzando una fascetta di cablaggio si può garantire la resistenza allo sfilamento del cavo (per i codici RPMPFCF...). Gli elementi passacavo possono essere di tipo "piccolo" per cavi con diametro fino a 16 mm e di tipo "grande" per cavi con diametro fino a 31 mm.

Cable grommets are used in conjunction with configurable or pre-configured cable entry systems. The grommets are in two pieces that must be close around the cable and they are equipped with catch hooks that anchor themselves in the cable entry system when positioning. Strain relief is achieved using a simple cable tie (for article codes RPMPFCF...). The grommets are available in two sizes, the "small" ones are suitable for cable with diameter up to 16 mm and the "large" one are suitable for cable with diameter up to 31 mm.

Dati tecnici - Technical data

Caratteristica - Characteristics	Valore/proprietà - Value/property	Riferimenti - Remarks
Materiale <i>Material</i>	Gomma termoplastica <i>Thermoplastic rubber</i>	-
Temperatura di esercizio <i>Temperature range</i>	-40°C, +80°C	-
Classe di autoestinguenza <i>Flammability rating</i>	HB	UL 94
Grado di protezione <i>Protection class</i>	IP 54 (montato sul cavo) <i>IP54 (mounted with cable)</i>	-
Colore <i>Color</i>	Nero <i>Black</i>	-

Codifiche e dimensioni - Coding and dimensions



Codice <i>Code</i>	Modello <i>Model</i>	Diametro del cavo <i>Cable diameter [mm]</i>	Numero di aperture <i>No. of openings</i>	Confezione <i>Packaging [pz]</i>
RPMPFCF03	Piccolo- <i>Small</i>	3÷4	1	10
RPMPFCF04	Piccolo- <i>Small</i>	4÷5	1	10
RPMPFCF05	Piccolo- <i>Small</i>	5÷6	1	10
RPMPFCF06	Piccolo- <i>Small</i>	6÷7	1	10
RPMPFCF07	Piccolo- <i>Small</i>	7÷8	1	10
RPMPFCF08	Piccolo- <i>Small</i>	8÷9	1	10
RPMPFCF09	Piccolo- <i>Small</i>	9÷10	1	10
RPMPFCF10	Piccolo- <i>Small</i>	10÷11	1	10
RPMPFCF11	Piccolo- <i>Small</i>	11÷12	1	10
RPMPFCF12	Piccolo- <i>Small</i>	12÷13	1	10
RPMPFCF13	Piccolo- <i>Small</i>	13÷14	1	10
RPMPFCF14	Piccolo- <i>Small</i>	14÷15	1	10
RPMPFCF15	Piccolo- <i>Small</i>	15÷16	1	10
RPMPFCF16	Grande- <i>Large</i>	16÷17	1	10
RPMPFCF17	Grande- <i>Large</i>	17÷18	1	10
RPMPFCF18	Grande- <i>Large</i>	18÷19	1	10
RPMPFCF19	Grande- <i>Large</i>	19÷20	1	10

Codice <i>Code</i>	Modello <i>Model</i>	Diametro del cavo <i>Cable diameter [mm]</i>	Numero di aperture <i>No. of openings</i>	Confezione <i>Packaging [pz]</i>
RPMPFC20	Grande- <i>Large</i>	20÷21	1	10
RPMPFC21	Grande- <i>Large</i>	21÷22	1	10
RPMPFC22	Grande- <i>Large</i>	22÷23	1	10
RPMPFC23	Grande- <i>Large</i>	23÷24	1	10
RPMPFC24	Grande- <i>Large</i>	24÷25	1	10
RPMPFC25	Grande- <i>Large</i>	25÷26	1	10
RPMPFC26	Grande- <i>Large</i>	26÷27	1	10
RPMPFC27	Grande- <i>Large</i>	27÷28	1	10
RPMPFC28	Grande- <i>Large</i>	28÷29	1	10
RPMPFC29	Grande- <i>Large</i>	29÷30	1	10
RPMPFC30	Grande- <i>Large</i>	30÷31	1	10
RPMP3-7	Piccolo- <i>Small</i>	3÷7	1	10
RPMP7-10	Piccolo- <i>Small</i>	7÷10	1	10
RPMP2X4	Piccolo- <i>Small</i>	4÷4,5	2	10
RPMP2X5	Piccolo- <i>Small</i>	5÷5,5	2	10
RPMP2X6	Piccolo- <i>Small</i>	6÷6,5	2	10
RPMP2XASI	Piccolo- <i>Small</i>	Cavo ASI	2	10
RPMPASI	Piccolo- <i>Small</i>	Cavo ASI	1	10
RPMPAGP	Grande- <i>Large</i>	Riduttore per elemento piccolo <i>Adapter for small grommet</i>	1	10
RPMPECP	Piccolo- <i>Small</i>	Elemento cieco <i>Dummy grommet</i>	0	10
RPMPECG	Grande- <i>Large</i>	Elemento cieco <i>Dummy grommet</i>	0	10



Appendice Appendix

Appendice A. Conduttori elettrici, sezioni e diametri

Appendix A. Wires, Sizes and AWG diameters

A.1 Misura dei conduttori elettrici, sezioni e diametri AWG and kcmil wires' sizes measurement

L'America Wire Gauge (AWG) è utilizzato negli Stati Uniti ed in altre nazioni come metodo standard per l'identificazione dei diametri di conduttori elettrici. L'aumento dei valori corrisponde alla diminuzione del diametro del conduttore; l'utilizzo di questa unità di misura deriva dal tipo di lavorazione che viene effettuata sul conduttore; conduttori molto fini (per esempio 30 AWG) richiedono numerosi passaggi di trafilatura mentre conduttori più grossi hanno passaggi più ridotti e di conseguenza l'AWG che li identifica è più basso.

Per definizione 36 AWG equivale ad un conduttore di diametro di 0,005 pollici mentre 4/0 AWG equivale ad un diametro di 0,46 pollici. I diametri aumentano di $0,46/0,005 = 92$ volte regolarmente suddivisi in 39 sezioni. Quindi il diametro di un conduttore avente una sezione di x AWG è dato da:

$$d_n = 0,005 \cdot 92^{\frac{36-x}{39}} \text{ [inch]}$$

mentre la sezione è

$$A_n = \frac{\pi}{4} \cdot d_n^2 = 0,000019635 \cdot 92^{\frac{36-x}{19,5}} \text{ [inch}^2\text{]}$$

dove per sezioni di m/0 AWG si deve usare $x = -(m-1)$ nelle formule precedenti.

The American Wire Gauge (AWG) is used in the United States and in other countries as a standard method of denoting wire diameter. Increasing gauge numbers give decreasing wire diameters; the use of this unit of measure derives from the type of processing carried out on the wire; very fine wire (for example 30 AWG) requires far more passes through the drawing dies than greater wires which, consequently, have a lower AWG identifying them. By definition, 36 AWG has the same value of a wire with 0,005 inches diameter, while 4/0 AWG has the same value of a 0,46 inches diameter. The diameters increase of $0,46/0,005 = 92$ times regularly divided in 39 Sizes. Therefore, the diameter of a wire with a x AWG Size is given as follows:

$$d_n = 0,005 \cdot 92^{\frac{36-x}{39}} \text{ [inch]}$$

while the Size is

$$A_n = \frac{\pi}{4} \cdot d_n^2 = 0,000019635 \cdot 92^{\frac{36-x}{19,5}} \text{ [inch}^2\text{]}$$

for m/0 AWG Size, use $x = -(m-1)$ in the above formulas.

Tabella A.1a. Sezioni AWG e conversione in mm²

Table A.1a. AWG Size and conversion mm²

AWG	Diametro - Diameter		Area [mm ²]
	[inch]	[mm]	
40	0,0031	0,07987	0,00501
39	0,0035	0,08969	0,00632
38	0,0040	0,1007	0,00797
37	0,0045	0,1131	0,0100
36	0,0050	0,1270	0,0127
35	0,0056	0,1426	0,0160
34	0,0063	0,1601	0,0201
33	0,0071	0,1798	0,0254
32	0,0080	0,2019	0,0320
31	0,0089	0,2268	0,0404
30	0,0100	0,2546	0,0509
29	0,0113	0,2859	0,0642
28	0,0126	0,3211	0,081
27	0,0142	0,3606	0,102
26	0,0159	0,4049	0,129
25	0,0179	0,4547	0,162
24	0,0201	0,5106	0,205
23	0,0226	0,5733	0,258
22	0,0253	0,6438	0,326
21	0,0285	0,7229	0,410
20	0,0320	0,8118	0,518
19	0,0359	0,9116	0,653
18	0,0403	1,024	0,823
17	0,0453	1,150	1,04
16	0,0508	1,291	1,31
15	0,0571	1,450	1,65
14	0,0641	1,628	2,08
13	0,0720	1,828	2,62
12	0,0808	2,053	3,31

AWG	Diametro - Diameter		Area [mm ²]
	[inch]	[mm]	
11	0,0907	2,305	4,17
10	0,1019	2,588	5,26
9	0,1144	2,906	6,63
8	0,1285	3,264	8,37
7	0,1443	3,665	10,5
6	0,1620	4,115	13,3
5	0,1819	4,621	16,8
4	0,2043	5,189	21,2
3	0,2294	5,827	26,7
2	0,2576	6,544	33,6
1	0,2893	7,348	42,4
0(1/0)	0,3249	8,251	53,5
00(2/0)	0,3648	9,266	67,4
000(3/0)	0,4096	10,40	85
0000(4/0)	0,4600	11,68	107
00000(5/0)	0,5165	13,12	135
000000(6/0)	0,5800	14,73	170

Le sezioni molto grandi vengono espresse in kcmil secondo la tabella seguente:
The larger Sizes are given in kcmil according to the following table:

Tabella A.1b. Sezioni kcmil e conversione in mm²
Table A.1b. kcmil Sizes and conversion in mm²

kcmil	Diametro - Diameter		Area [mm ²]
	[inch]	[mm]	
250	0,50	12,7	127
300	0,55	13,9	152
350	0,59	15,0	177
400	0,63	16,1	203
450	0,67	17,0	228
500	0,71	17,9	253
550	0,74	18,8	279
600	0,77	19,7	304
650	0,81	20,5	329
700	0,84	21,3	355
750	0,87	22,0	380
800	0,89	22,7	405
900	0,95	24,1	456
1000	1,00	25,4	507
1200	1,10	27,8	608
1250	1,12	28,4	633
1500	1,22	31,1	760
1750	1,32	33,6	887
2000	1,41	35,9	1010

A.2 Conduttori elettrici secondo EN 60228 Wires according to EN 60228

La norma EN 60228 "Conduttori per cavi isolati" definisce le caratteristiche dei conduttori solidi (classe 1), dei conduttori a trefolo (classe 2) e di quelli flessibili (classe 5 e 6) nel modo seguente.

Conduttori solidi (classe 1)

- I conduttori solidi sono realizzati in rame rosso o stagnato.
- I conduttori solidi in rame devono essere a sezione circolare.
- La resistenza dei conduttori misurata a 20°C non deve eccedere quella indicata in Tabella A.2a.

Conduttori a trefolo (classe 2)

- I conduttori a trefolo circolari sono realizzati in rame rosso o stagnato.
- I fili elementari in ogni conduttore devono avere lo stesso diametro.
- Il numero dei fili elementari presenti in ogni conduttore non deve essere inferiore al numero indicato nella Tabella A.2b.
- La resistenza dei conduttori misurata a 20°C non deve superare il valore indicato nella Tabella A.2b.

Conduttori flessibili (classe 5 e 6)

- I conduttori flessibili sono realizzati in rame rosso o stagnato.
- I fili elementari in ogni conduttore devono avere lo stesso diametro.
- Il diametro dei fili elementari presenti in ogni conduttore non deve superare il valore indicato nella Tabella A.2c e Tabella A.2d.
- La resistenza dei conduttori misurata a 20°C non deve superare il valore indicato nella Tabella A.2c e Tabella A.2d.

The EN 60228 "Conductors of insulated cables" standard defines the characteristics of the solid conductors (class 1), stranded conductors (class 2) and flexible conductors (class 5 and 6) as follow.

Solid conductors (class 1)

- Solid conductors are made of bare or tinned copper.
- Solid copper conductors shall be of circular cross-section.
- The resistance of each conductor at 20°C must not exceed the value given in the Table A.2a.

Stranded conductors (class 2)

- The stranded circular conductors are made of bare or tinned copper.
- The wires in each conductor must have the same nominal diameter.
- The number of wires in each conductor shall be not less than the value given in the Table A.2b.
- The resistance of each conductor at 20°C must not exceed the value given in the Table A.2b.

Flexible conductors (class 5 and 6)

- The flexible conductors are made of bare or tinned copper.
- The wires in each conductor must have the same nominal diameter.
- The diameter of the wires in each conductor must not exceed the value given in the Table A.2c and Table A.2d.
- The resistance of each conductor at 20°C must not exceed the value given in the Table A.2c and Table A.2d.

Tabella A.2a. Caratteristiche dei conduttori solidi in rame di classe 1 per la produzione di cavi secondo CEI EN 60228:2005
Table A.2a. Characteristics of the copper solid conductors, class 1, for the production of cables according to CEI EN 60228:2005

Sezione nominale [mm ²] <i>Nominal Size</i>	Massima resistenza del conduttore a 20°C <i>Maximum resistance of the wire at 20°C [Ω /km]</i>	
	Rame rosso <i>Bare copper</i>	Rame stagnato <i>Tinned copper</i>
0,5	36,0	36,7
0,75	24,5	24,8
1,0	18,1	18,2
1,5	12,1	12,2
2,5	7,41	7,56
4	4,61	4,70
6	3,08	3,11
10	1,83	1,84
16	1,15	1,16
25	0,727	-
35	0,524	-
50	0,387	-
70	0,268	-
95	0,193	-
120	0,153	-
150	0,124	-
185	0,101	-
240	0,0775	-
300	0,0620	-
400	0,0465	-

Tabella A.2b. Caratteristiche dei conduttori a trefolo in rame di classe 2 per la produzione di cavi secondo CEI EN 60228:2005

Table A.2b. Characteristics of the copper stranded conductors, class 2, for the production of cables according to CEI EN 60228:2005

Sezione nominale [mm ²] <i>Nominal Size</i>	Numero minimo di fili elementari <i>Minimum number of wires in the conductor</i>	Massima resistenza del conduttore a 20°C <i>Maximum resistance of the wire at 20°C [Ω /km]</i>	
		Rame rosso <i>Bare copper</i>	Rame stagnato <i>Tinned copper</i>
0,5	7	36,0	36,7
0,75	7	24,5	24,8
1,0	7	18,1	18,2
1,5	7	12,1	12,2
2,5	7	7,41	7,56
4	7	4,61	4,70
6	7	3,08	3,11
10	7	1,83	1,84
16	7	1,15	1,16
25	7	0,727	0,734
35	7	0,524	0,529
50	19	0,387	0,391
70	19	0,268	0,270
95	19	0,193	0,195
120	37	0,153	0,154
150	37	0,124	0,126
185	37	0,0991	0,100
240	37	0,0754	0,0762
300	61	0,0601	0,0607
400	61	0,0470	0,0475
500	61	0,0366	0,0369
630	91	0,0283	0,0286
800	91	0,0221	0,0224
1000	91	0,0176	0,0177

Tabella A.2c. Caratteristiche dei conduttori flessibili in rame di classe 5 per la produzione di cavi secondo CEI EN 60228:2005

Table A.2c. Characteristics of the copper flexible conductors, class 5, for the production of cables according to CEI EN 60228:2005

Sezione nominale [mm ²] <i>Nominal Size</i>	Massimo diametro del filo elementare <i>Maximum diameter of the wires in conductor</i>	Massima resistenza del conduttore a 20°C <i>Maximum resistance of the wire at 20°C [Ω /km]</i>	
		Rame rosso <i>Bare copper</i>	Rame stagnato <i>Tinned copper</i>
0,5	0,21	39,0	40,1
0,75	0,21	26,0	26,7
1,0	0,21	19,5	20,0
1,5	0,26	13,3	13,7
2,5	0,26	7,98	8,21
4	0,31	4,95	5,09
6	0,31	3,30	3,39
10	0,41	1,91	1,95
16	0,41	1,21	1,24
25	0,41	0,780	0,795
35	0,41	0,554	0,565
50	0,41	0,386	0,393
70	0,51	0,272	0,277
95	0,51	0,206	0,210
120	0,51	0,161	0,164
150	0,51	0,129	0,132
185	0,51	0,106	0,108
240	0,51	0,0801	0,0817
300	0,51	0,0641	0,0654
400	0,51	0,0486	0,0495
500	0,61	0,0384	0,0391
630	0,61	0,0287	0,0292

Tabella A.2d. Caratteristiche dei conduttori flessibili in rame di classe 6 per la produzione di cavi secondo CEI EN 60228:2005

Table A.2d. Characteristics of the copper flexible conductors, class 6, for the production of cables according to CEI EN 60228:2005

Sezione nominale [mm ²] <i>Nominal Size</i>	Massimo diametro del filo elementare [mm] <i>Maximum diameter of the wires in conductor</i>	Massima resistenza del conduttore a 20°C <i>Maximum resistance of the wire at 20°C [Ω /km]</i>	
		Rame rosso <i>Bare copper</i>	Rame stagnato <i>Tinned copper</i>
0,5	0,16	39,0	40,1
0,75	0,16	26,0	26,7
1,0	0,16	19,5	20,0
1,5	0,16	13,3	13,7
2,5	0,16	7,98	8,21
4	0,16	4,95	5,09
6	0,21	3,30	3,39
10	0,21	1,91	1,95
16	0,21	1,21	1,24
25	0,21	0,780	0,795
35	0,21	0,554	0,565
50	0,31	0,386	0,393
70	0,31	0,272	0,277
95	0,31	0,206	0,210
120	0,31	0,161	0,164
150	0,31	0,129	0,132
185	0,41	0,106	0,108
240	0,41	0,0801	0,0817
300	0,41	0,0641	0,0654

A.3 Correlazione tra le sezioni dei conduttori in AWG e IEC Wires, correlations between AWG and IEC Sizes

Tabella A.3. Correlazione tra le sezioni dei cavi in mm² (IEC) e in AWG
Table A.3. Correlation between mm² (IEC) and AWG cable Sizes

Sezioni Sizes		Sezione equivalente Equivalent area [mm ²]		
[mm ²]	[AWG]	[mm ²]	[inch ²]	[kcmil]
0,2		0,196	0,000304	387
	24	0,205	0,000317	404
0,3		0,283	0,000438	558
	22	0,324	0,000504	640
0,5		0,5	0,000775	987
	20	0,519	0,000802	1020
0,75		0,75	0,001162	1480
	18	0,823	0,001272	1620
1		1	0,00155	1973
	16	1,31	0,002026	2580
1,5		1,5	0,002325	2960
	14	2,08	0,003228	4110
2,5		2,5	0,003875	4934
	12	3,31	0,005129	6530
4		4	0,0062	7894
	10	5,26	0,008152	10380
6		6	0,0092	11841
	8	8,37	0,012967	16510
10		10	0,0155	19735
	6	13,3	0,02061	26240
16		16	0,0248	31576
	4	21,1	0,03278	41641
25		25	0,0388	49338
	2	33,6	0,0521	66310
35		35	0,0542	69073
	1	42,4	0,0657	83677
50		47	0,0728	92756

Esempio

Un conduttore avente sezione effettiva 10 mm² può essere utilizzato come conduttore 8 AWG in quanto la sezione è 10 mm² > 8,37 mm².

Al contrario, un conduttore prodotto con sezione effettiva 18 AWG non può essere utilizzato come conduttore da 1 mm² poiché la sezione equivalente è 0,823 mm² < 1 mm².

Example

A 10 mm² wire can be used as an 8 AWG wire because its size is 10 mm² > 8,37 mm².

On the contrary, a 18 AWG wire cannot be used as a 1 mm² wire because its equivalent size is 0,823 mm² < 1 mm².

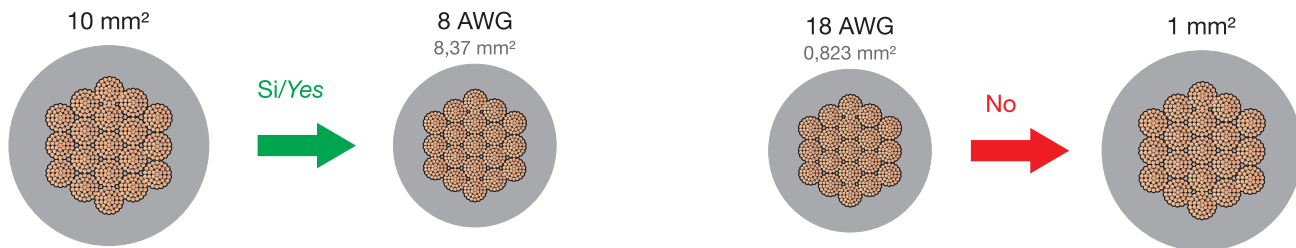

A.4 Sezioni minime dei conduttori secondo EN 60204-1

Minimum cross-Sizeal areas of copper conductors according to EN 60204-1

Tabella A.4. Sezioni minime dei conduttori di rame in funzione del tipo di applicazione secondo IEC 60204-1:2018

Table A.4. Minimum cross-Sizeal areas of copper conductors by application according to IEC 60204-1:2018

Luogo <i>Location</i>	Applicazione <i>Application</i>	Sezione minima [mm ²] in funzione del tipo di cavo <i>Minimum cross-Sizeal area [mm²] by type of cable</i>				
		Unipolare <i>Single core</i>		Multipolare <i>Multicore</i>		
		Flessibile Classe 5 o 6 <i>Flexible Calss 5 or 6</i>	A filo unico (Classe 1) o cordato (Classe 2) <i>Solid (Class 1) or stranded (Class 2)</i>	Due poli, schermato <i>Two cores, shielded</i>	Due poli, non schermato <i>Two cores, not shielded</i>	Tre o più poli, scherma- to o non schermato <i>Three or more cores, shielded or not</i>
Cablaggi all'esterno degli involucri di protezione <i>Wiring outside protecting enclosures</i>	Circuiti di potenza, fissi <i>Power circuits, fixed</i>	1,0	1,5	0,75	0,75	0,75
	Circuiti di potenza, soggetti a movimenti frequentissimi <i>Power circuits, subjected to frequent movements</i>	1,0	-	0,75	0,75	0,75
	Circuiti di comando <i>Control circuits</i>	1,0	1,0	0,2	0,5	0,2
	Comunicazione dati <i>Data communication</i>	-	-	-	-	0,08
Cablaggi all'interno degli involucri <i>Wiring inside enclosures</i>	Circuiti di potenza (connessioni non soggette a movimenti) <i>Power circuits (connections and moved)</i>	0,75	0,75	0,75	0,75	0,75
	Circuiti di comando <i>Control circuits</i>	0,2	0,2	0,2	0,2	0,2
	Comunicazione dati <i>Data communication</i>	-	-	-	-	0,08

Appendice B. Portate dei conduttori

Appendix B. Ampacities of wires

B.1 Portate dei conduttori secondo UL 508a

Wires ampacities according to UL 508a

Le tabelle mostrano le portate dei conduttori pubblicate nella norma alla quale si deve fare sempre riferimento.

The tables show the ampacities of the conductors published in the standard to which reference must always be made.

Portate dei conduttori di terra secondo UL 508a

Size of equipment grounding conductor terminal according to UL 508a

Tabella B.1a. Portate dei conduttori di terra secondo UL 508a - Rev. 2007-2018 (15 Grounding - Size of Terminal or Bonding Conductor)

Table B.1a. Earth wire capacities according to UL 508a - Rev. 2007-2018 (15 Grounding - Size of Terminal or Bonding Conductor)

Corrente massima Maximum current [A]	Sezione minima del conduttore di terra Minimum Size of the earth wire			
	Conduttore in rame Copper wire		Conduttore in alluminio Aluminium wire	
	[AWG/kcmil]	[mm ²]	[AWG/kcmil]	[mm ²]
15	14 AWG	2,1	12 AWG	3,3
20	12	3,3	10	5,3
30	10	5,3	8	8,4
40	10	5,3	8	8,4
60	10	5,3	8	8,4
100	8	8,4	6	13,3
200	6	13,3	4	21,2
300	4	21,2	2	33,6
400	3	26,7	1	42,4
500	2	33,6	1/0	53,5
600	1	42,4	2/0	67,4
800	1/0	53,5	3/0	85,0
1000	2/0	67,4	4/0	107,2
1200	3/0	85,0	250 kcmil	127
1600	4/0	107,2	350	177
2000	250 kcmil	127	400	203
2500	350	177	600	304
3000	400	203	600	304
4000	500	253	800	405
5000	700	355	1200	608
6000	800	506	1200	608

Portate dei conduttori di potenza secondo UL 508a

Ampacities of power conductors according to UL 508a

Tabella B.1b. Portate dei conduttori di potenza installati in campo o all'interno del quadro elettrico secondo UL 508a - Rev. 2007-2018 (28.3 & 29.6 Sizing)

Table B.1b. Ampacities of field installed or internal power insulated conductors according to UL 508a - Rev. 2007-2018 (28.3 & 29.6 Sizing)

Sezione del conduttore Wire Size		Portata massima del conduttore a 60°C (140°F) Insulated conductor ampacity at 60°C (140°F) [A]		Portata massima del conduttore a 75°C (167°F) Insulated conductor ampacity at 75°C (167°F) [A]	
[AWG/kcmil]	[mm ²]	Conduttore in rame Copper wire	Conduttore in alluminio Aluminium wire	Conduttore in rame Aluminium wire	Conduttore in alluminio Aluminium wire
14 AWG	2,1	15	—	15	—
12	3,3	20	15	20	15
10	5,3	30	25	30	25
8	8,4	40	30	50	40
6	13,3	55	40	65	50
4	21,2	70	55	85	65
3	26,7	85	65	100	75
2	33,6	95	75	115	90
1	42,4	110	85	130	100

Sezione del conduttore Wire Size		Portata massima del conduttore a 60°C (140°F) Insulated conductor ampacity at 60°C (140°F) [A]		Portata massima del conduttore a 75°C (167°F) Insulated conductor ampacity at 75°C (167°F) [A]	
[AWG/kcmil]	[mm ²]	Conduttore in rame Copper wire	Conduttore in alluminio Aluminium wire	Conduttore in rame Aluminium wire	Conduttore in alluminio Aluminium wire
1/0	53,5	–	–	150	120
2/0	67,4	–	–	175	135
3/0	85,0	–	–	200	155
4/0	107,2	–	–	230	180
250 kcmil	127	–	–	255	205
300	152	–	–	285	230
350	177	–	–	310	250
400	203	–	–	335	270
500	253	–	–	380	310
600	304	–	–	420	340
700	355	–	–	460	375
750	380	–	–	475	385
800	405	–	–	490	395
900	456	–	–	520	425
1000	506	–	–	545	445
1250	633	–	–	590	485
1500	760	–	–	625	520
1750	887	–	–	650	545
2000	1013	–	–	665	560

Questi valori sono applicabili quando i conduttori in campo installati in conduit non sono più di tre. Quando nel conduit sono installati quattro o più conduttori, oltre al conduttore neutro, la portata di ogni conduttore deve essere ridotta al: 80% del valore riportato per 4÷6 conduttori, 70% per 7÷24 conduttori, 60% per 25÷42 conduttori o 50% per più di 43 conduttori.

These values of ampacity apply only when not more than three conductors are intended to be field-installed in the conduit. When four or more conductors, other than a neutral that carries the unbalanced current, are intended to be installed in a conduit, the ampacity of each of the conductors is: 80 percent of these values if 4 – 6 conductors are involved, 70 percent of these values if 7 – 24 conductors, 60 percent of these values if 25 – 42 conductors, and 50 percent of these values if 43 or more conductors

Portate dei conduttori di comando e controllo installati in campo secondo UL 508a Ampacities of field installed control circuit conductors according to UL 508a

Tabella B.1c. Portate dei conduttori di comando e controllo installati in campo secondo UL 508a – Rev. 2007-2018 (37.2 Sizing)
Table B.1c. Ampacities of field installed control circuit conductors according to UL 508a – Rev. 2007-2018 (37.2 Sizing)

Sezione del conduttore Wire Size		Portata massima del conduttore Conductor ampacity [A]	La sezione deve essere stampigliata sul conduttore? Conductor marking required?
[AWG]	[mm ²]		
16	1,3	10	Si - Yes
16 ÷ 14	1,3 ÷ 2,1	10	No
18	0,82	7	Si - Yes
18 ÷ 14	0,82 ÷ 2,1	7	No
20 ÷ 18	0,52 ÷ 0,82	5	Si - Yes
20 ÷ 14	0,52 ÷ 2,1	5	No
22 ÷ 18	0,32 ÷ 0,82	3	Si - Yes
22 ÷ 14	0,32 ÷ 2,1	3	No
24 ÷ 18	0,20 ÷ 0,82	2	Si - Yes
24 ÷ 14	0,20 ÷ 2,1	2	No
26 ÷ 18	0,13 ÷ 0,82	1	Si - Yes
26 ÷ 14	0,13 ÷ 2,1	1	No
28 ÷ 18	0,08 ÷ 0,82	0,8	Si - Yes
28 ÷ 14	0,08 ÷ 2,1	0,8	No
30 ÷ 18	0,05 ÷ 0,82	0,5	Si - Yes
30 ÷ 14	0,05 ÷ 2,1	0,5	No

Portate dei conduttori di comando e controllo installati all'interno del quadro elettrico secondo UL 508a Ampacities of internal control circuit conductors according to UL 508a

Tabella B.1d. Portate dei conduttori di comando e controllo installati all'interno del quadro elettrico secondo UL 508a - Rev. 2007-2018 (38.2 Sizing of internal control circuit conductors)
Table B.1d. Ampacities of internal control circuit conductors according to UL 508a - Rev. 2007-2018 (38.2 Sizing of internal control circuit conductors)

Sezione del conduttore Size		Portata massima del conduttore Conductor ampacity [A]
[AWG]	[mm ²]	
16	1,3	10
18	0,82	7
20 ^(b)	0,52	5
22 ^(b)	0,32	3
24 ^(b)	0,20	2
26 ^(b)	0,13	1
28 ^{(a) (b)}	0,08	0,8
30 ^{(a) (b)}	0,05	0,5

^(a) Solo quando questi conduttori sono assemblati in un cavo multipolare.

^(b) Solo quando questi conduttori sono usati per circuiti di controllo di apparecchiature elettroniche non aventi parti in movimento.

^(a) Where these conductors are contained in a jacketed multi-conductor cable assembly.

^(b) These sizes of conductors are only for connection of control circuits for electronic programmable input/output and static control (having no moving parts).

B.2 Portate dei conduttori secondo CSA C22.2 No. 286 Ampacity of conductors according to CSA C22.2 No. 286

Le tabelle mostrano le portate dei conduttori pubblicate nella norma alla quale si deve fare sempre riferimento.

The tables show the ampacities of the conductors published in the standard to which reference must always be made.

Tabella B.2a. Portata di conduttori all'interno del quadro elettrico (temperatura ambiente 40°C) secondo CSA C22.2 No.286 – Ed. 2015-2017 (Clause 4.6.2, Table 7)

Table B.2a. Allowable ampacities of insulated copper conductors inside industrial control equipment enclosures (ambient temperature 40°C) according to CSA C22.2 No.286 – Ed. 2015-2017 (Clause 4.6.2, Table 7)

Sezione del conduttore Wire Size [AWG/kcmil]	Portata del conduttore in rame con isolamento a 90°C Copper conductor's ampacity with 90 °C insulation [A]		Portata del conduttore in rame con isolamento a 105°C Copper conductor's ampacity with 105 °C insulation [A]	
	Quadro non ventilato Non-ventilated enclosure	Quadro aperto o ventilato Open or in ventilated enclosure	Quadro non ventilato Non-ventilated enclosure	Quadro aperto o ventilato Open or in ventilated enclosure
24 AWG	1	2	1	2
22	2	3	2	3
20	3	4	3	4
18	4	6	4	6
16	6	9	6	9
14	9	13	10	15
12	12	17	15	22
10	18	27	22	35
8	31	47	35	55
6	45	67	52	80
4	61	91	71	108
3	70	104	80	121
2	80	120	90	140
1	94	141	107	164
0	110	164	133	190
00	128	191	148	221
000	148	221	171	257
0000	173	258	200	300
250 kcmil	194	285	221	340
300	214	322	250	384
350	242	355	276	420
400	262	385	299	449
500	298	442	343	515

Tabella B.2b. Fattori di correzione delle portate in funzione del numero di conduttori secondo CSA C22.2 No.286 – Ed. 2015-2017 (Clause 4.6.2, Table 8)

Table B.2b. Ampacity adjustment factors based on the number of c conductors according CSA C22.2 No.286 – Ed. 2015-2017 (Clause 4.6.2, Table 8)

Numero di conduttori Number of conductors	Coefficiente di correzione Correction factor
1÷3	1,00
4÷6	0,80
7÷24	0,70
25÷42	0,60
>42	0,50

B.3 Portate dei conduttori secondo NFPA 79 Ampacities of conductors according to NFPA 79

Le tabelle mostrano le portate dei conduttori pubblicate nella norma alla quale si deve fare sempre riferimento.
The tables show the ampacities of the conductors published in the standard to which reference must always be made.

Tabella B.3a. Portate dei conduttori con temperatura di isolamento 60°C secondo NFPA 79 – Ed. 2007 - Table 12.5.1
Table B.3a. Ampacities of conductors with 60°C insulation temperature according to NFPA 79 – Ed. 2007 - Table 12.5.1

Sezione del conduttore [AWG/kcmil] Size	Portata massima per conduttori in rame isolati [A], Temperatura dell'isolamento 60°C Allowable ampacities of insulated copper conductors [A], Insulation temperature 60°C									
	Temperatura ambiente Ta Ambient temperature Ta									
	21÷25°C	26÷30°C	31÷35°C	36÷40°C	41÷45°C	46÷50°C	51÷55°C	56÷60°C	61÷70°C	71÷80°C
30 AWG	-	-	-	-	-	-	-	-	-	-
28	-	-	-	-	-	-	-	-	-	-
26	-	-	-	-	-	-	-	-	-	-
24	2,1	2,0	1,8	1,7	1,6	1,5	1,3	1,1	-	-
22	3,1	3,0	2,8	2,6	2,4	2,2	2,0	1,7	-	-
20	5,2	5,0	4,7	4,4	4,1	3,7	3,3	2,9	-	-
18	7,3	7,0	6,5	6,1	5,7	5,2	4,6	4,0	-	-
16	10,5	10,0	9,4	8,8	8,2	7,5	6,7	5,8	-	-
14	15,7	15,0	14,1	13,2	12,3	11,2	10,0	8,7	-	-
12	21,0	20,0	18,8	17,6	16,4	15,0	13,4	11,6	-	-
10	31,5	30,0	28,2	26,4	24,6	22,5	20,1	17,4	-	-
8	42,0	40,0	37,6	35,2	32,8	30,0	26,8	23,2	-	-
6	57,7	55,0	51,7	48,4	45,1	41,2	36,8	31,9	-	-
4	73,5	70,0	65,8	61,6	57,4	52,5	46,9	40,6	-	-
3	89,2	85,0	79,9	74,8	69,7	63,7	56,9	49,3	-	-
2	99,7	95,0	89,3	83,6	77,9	71,2	63,6	55,1	-	-
1	115,5	110,0	103,4	96,8	90,2	82,5	73,7	63,8	-	-
1/0	131,2	125,0	117,5	110,0	102,5	93,7	83,7	72,5	-	-
2/0	152,2	145,0	136,3	127,6	118,9	108,7	97,1	84,1	-	-
3/0	173,2	165,0	155,1	145,2	135,3	123,7	110,5	95,7	-	-
4/0	204,7	195,0	183,3	171,6	159,9	146,2	130,6	113,1	-	-
250 kcmil	225,7	215,0	202,1	189,2	176,3	161,2	144,0	124,7	-	-
300	252,0	240,0	225,6	211,2	196,8	180,0	160,8	139,2	-	-
350	273,0	260,0	244,4	228,8	213,2	195,0	174,2	150,8	-	-
400	294,0	280,0	263,2	246,4	229,6	210,0	187,6	162,4	-	-
500	336,0	320,0	300,8	281,6	262,4	240,0	214,4	185,6	-	-
600	372,7	355,0	333,7	312,4	291,1	266,2	237,8	205,9	-	-
700	404,2	385,0	361,9	338,8	315,7	288,7	257,9	223,3	-	-
750	420,0	400,0	376,0	352,0	328,0	300,0	268,0	232,0	-	-
800	430,5	410,0	385,4	360,8	336,2	307,5	274,7	237,8	-	-
900	456,7	435,0	408,9	382,8	356,7	326,2	291,4	252,3	-	-
1000	477,7	455,0	427,7	400,4	373,1	341,2	304,8	263,9	-	-

Tabella B.3b. Portate dei conduttori con temperatura di isolamento 75°C secondo NFPA 79 – Ed. 2007 - Table 12.5.1
 Table B.3b. Ampacities of conductors with 75°C insulation temperature according to NFPA 79 – Ed. 2007 - Table 12.5.1

Sezione del conduttore [AWG/kcmil] Size	Portata massima per conduttori in rame isolati [A], Temperatura dell'isolamento 75°C Allowable ampacities of insulated copper conductors [A] Insulation temperature 75°C									
	Temperatura ambiente Ta Ambient temperature Ta									
	21÷25°C	26÷30°C	31÷35°C	36÷40°C	41÷45°C	46÷50°C	51÷55°C	56÷60°C	61÷70°C	71÷80°C
30 AWG	0,5	0,5	0,4	0,4	0,4	0,3	0,3	0,2	0,1	-
28	0,8	0,8	0,7	0,7	0,6	0,6	0,5	0,4	0,2	-
26	1,0	1,0	0,9	0,8	0,8	0,7	0,6	0,5	0,3	-
24	2,1	2,0	1,8	1,7	1,6	1,5	1,3	1,1	0,6	-
22	3,1	3,0	2,8	2,6	2,4	2,2	2,0	1,7	0,9	-
20	5,2	5,0	4,7	4,4	4,1	3,7	3,3	2,9	1,6	-
18	7,3	7,0	6,5	6,1	5,7	5,2	4,6	4,0	2,3	-
16	10,5	10,0	9,4	8,8	8,2	7,5	6,7	5,8	3,3	-
14	15,7	15,0	14,1	13,2	12,3	11,2	10,0	8,7	4,9	-
12	21,0	20,0	18,8	17,6	16,4	15,0	13,4	11,6	6,6	-
10	31,5	30,0	28,2	26,4	24,6	22,5	20,1	17,4	9,9	-
8	52,5	50,0	47,0	44,0	41,0	37,5	33,5	29,0	16,5	-
6	68,2	65,0	61,1	57,2	53,3	48,7	43,5	37,7	21,4	-
4	89,2	85,0	79,9	74,8	69,7	63,7	56,9	49,3	28,0	-
3	105,0	100,0	94,0	88,0	82,0	75,0	67,0	58,0	33,0	-
2	120,7	115,0	108,1	101,2	94,3	86,2	77,0	66,7	37,9	-
1	136,5	130,0	122,2	114,4	106,6	97,5	87,1	75,4	42,9	-
1/0	157,5	150,0	141,0	132,0	123,0	112,5	100,5	87,0	49,5	-
2/0	183,7	175,0	164,5	154,0	143,5	131,2	117,2	101,5	57,7	-
3/0	210,0	200,0	188,0	176,0	164,0	150,0	134,0	116,0	66,0	-
4/0	241,5	230,0	216,2	202,4	188,6	172,5	154,1	133,4	75,9	-
250 kcmil	267,7	255,0	239,7	224,4	209,1	191,2	170,8	147,9	84,1	-
300	299,2	285,0	267,9	250,8	233,7	213,7	190,9	165,3	94,0	-
350	325,5	310,0	291,4	272,8	254,2	232,5	207,7	179,8	102,3	-
400	351,7	335,0	314,9	294,8	274,7	251,2	224,4	194,3	110,5	-
500	399,0	380,0	357,2	334,4	311,6	285,0	254,6	220,4	125,4	-
600	441,0	420,0	394,8	369,6	344,4	315,0	281,4	243,6	138,6	-
700	483,0	460,0	432,4	404,8	377,2	345,0	308,2	266,8	151,8	-
750	498,7	475,0	446,5	418,0	389,5	356,2	318,2	275,5	156,7	-
800	514,5	490,0	460,6	431,2	401,8	367,5	328,3	284,2	161,7	-
900	546,0	520,0	488,8	457,6	426,4	390,0	348,4	301,6	171,6	-
1000	572,2	545,0	512,3	479,6	446,9	408,7	365,1	316,1	179,8	-

Tabella B.3c. Portate dei conduttori con temperatura di isolamento 60°C secondo NFPA 79 – Ed. 2012 - Table 12.5.1
 Table B.3c. Ampacities of conductors with 60°C insulation temperature according to NFPA 79 – Ed. 2012 - Table 12.5.1

Sezione del conduttore [AWG/kcmil] Size	Portata massima per conduttori in rame isolati [A], Temperatura dell'isolamento 60°C Allowable ampacities of insulated copper conductors [A] Insulation temperature 60°C									
	Temperatura ambiente Ta Ambient temperature Ta									
	21÷25°C	26÷30°C	31÷35°C	36÷40°C	41÷45°C	46÷50°C	51÷55°C	56÷60°C	61÷70°C	71÷80°C
30 AWG	-	-	-	-	-	-	-	-	-	-
28	-	-	-	-	-	-	-	-	-	-
26	-	-	-	-	-	-	-	-	-	-
24	2,1	2,0	1,8	1,7	1,6	1,5	1,3	1,1	-	-
22	3,1	3,0	2,8	2,6	2,4	2,2	2,0	1,7	-	-
20	5,2	5,0	4,7	4,4	4,1	3,7	3,3	2,9	-	-
18	7,3	7,0	6,5	6,1	5,7	5,2	4,6	4,0	-	-
16	10,5	10,0	9,4	8,8	8,2	7,5	6,7	5,8	-	-
14	21,0	20,0	18,8	17,6	16,4	15,0	13,4	11,6	-	-
12	26,2	25,0	23,5	22,0	20,5	18,7	16,7	14,5	-	-
10	31,5	30,0	28,2	26,4	24,6	22,5	20,1	17,4	-	-
8	42,0	40,0	37,6	35,2	32,8	30,0	26,8	23,2	-	-
6	57,7	55,0	51,7	48,4	45,1	41,2	36,8	31,9	-	-
4	73,5	70,0	65,8	61,6	57,4	52,5	46,9	40,6	-	-
3	89,2	85,0	79,9	74,8	69,7	63,7	56,9	49,3	-	-
2	99,7	95,0	89,3	83,6	77,9	71,2	63,6	55,1	-	-
1	115,5	110,0	103,4	96,8	90,2	82,5	73,7	63,8	-	-
1/0	131,2	125,0	117,5	110,0	102,5	93,7	83,7	72,5	-	-
2/0	152,2	145,0	136,3	127,6	118,9	108,7	97,1	84,1	-	-
3/0	173,2	165,0	155,1	145,2	135,3	123,7	110,5	95,7	-	-
4/0	204,7	195,0	183,3	171,6	159,9	146,2	130,6	113,1	-	-
250 kcmil	225,7	215,0	202,1	189,2	176,3	161,2	144,0	124,7	-	-
300	252,0	240,0	225,6	211,2	196,8	180,0	160,8	139,2	-	-
350	273,0	260,0	244,4	228,8	213,2	195,0	174,2	150,8	-	-
400	294,0	280,0	263,2	246,4	229,6	210,0	187,6	162,4	-	-
500	336,0	320,0	300,8	281,6	262,4	240,0	214,4	185,6	-	-
600	372,7	355,0	333,7	312,4	291,1	266,2	237,8	205,9	-	-
700	404,2	385,0	361,9	338,8	315,7	288,7	257,9	223,3	-	-
750	420,0	400,0	376,0	352,0	328,0	300,0	268,0	232,0	-	-
800	430,5	410,0	385,4	360,8	336,2	307,5	274,7	237,8	-	-
900	456,7	435,0	408,9	382,8	356,7	326,2	291,4	252,3	-	-
1000	477,7	455,0	427,7	400,4	373,1	341,2	304,8	263,9	-	-

Tabella B.3d. Portate dei conduttori con temperatura di isolamento 75°C secondo NFPA 79 – Ed. 2012 - Table 12.5.1
 Table B.3d. Ampacities of conductors with 75°C insulation temperature according to NFPA 79 – Ed. 2012 - Table 12.5.1

Sezione del conduttore [AWG/kcmil] Size	Portata massima per conduttori in rame isolati [A], Temperatura dell'isolamento 75°C Allowable ampacities of insulated copper conductors [A] Insulation temperature 75°C									
	Temperatura ambiente Ta Ambient temperature Ta									
	21÷25°C	26÷30°C	31÷35°C	36÷40°C	41÷45°C	46÷50°C	51÷55°C	56÷60°C	61÷70°C	71÷80°C
30 AWG	0,5	0,5	0,4	0,4	0,4	0,3	0,3	0,2	0,1	-
28	0,8	0,8	0,7	0,7	0,6	0,6	0,5	0,4	0,2	-
26	1,0	1,0	0,9	0,8	0,8	0,7	0,6	0,5	0,3	-
24	2,1	2,0	1,8	1,7	1,6	1,5	1,3	1,1	0,6	-
22	3,1	3,0	2,8	2,6	2,4	2,2	2,0	1,7	0,9	-
20	5,2	5,0	4,7	4,4	4,1	3,7	3,3	2,9	1,6	-
18	7,3	7,0	6,5	6,1	5,7	5,2	4,6	4,0	2,3	-
16	10,5	10,0	9,4	8,8	8,2	7,5	6,7	5,8	3,3	-
14	21,0	20,0	18,8	17,6	16,4	15,0	13,4	11,6	6,6	-
12	26,2	25,0	23,5	22,0	20,5	18,7	16,7	14,5	8,2	-
10	36,7	35,0	32,9	30,8	28,7	26,2	23,4	20,3	11,5	-
8	52,5	50,0	47,0	44,0	41,0	37,5	33,5	29,0	16,5	-
6	68,2	65,0	61,1	57,2	53,3	48,7	43,5	37,7	21,4	-
4	89,2	85,0	79,9	74,8	69,7	63,7	56,9	49,3	28,0	-
3	105,0	100,0	94,0	88,0	82,0	75,0	67,0	58,0	33,0	-
2	120,7	115,0	108,1	101,2	94,3	86,2	77,0	66,7	37,9	-
1	136,5	130,0	122,2	114,4	106,6	97,5	87,1	75,4	42,9	-
1/0	157,5	150,0	141,0	132,0	123,0	112,5	100,5	87,0	49,5	-
2/0	183,7	175,0	164,5	154,0	143,5	131,2	117,2	101,5	57,7	-
3/0	210,0	200,0	188,0	176,0	164,0	150,0	134,0	116,0	66,0	-
4/0	241,5	230,0	216,2	202,4	188,6	172,5	154,1	133,4	75,9	-
250 kcmil	267,7	255,0	239,7	224,4	209,1	191,2	170,8	147,9	84,1	-
300	299,2	285,0	267,9	250,8	233,7	213,7	190,9	165,3	94,0	-
350	325,5	310,0	291,4	272,8	254,2	232,5	207,7	179,8	102,3	-
400	351,7	335,0	314,9	294,8	274,7	251,2	224,4	194,3	110,5	-
500	399,0	380,0	357,2	334,4	311,6	285,0	254,6	220,4	125,4	-
600	441,0	420,0	394,8	369,6	344,4	315,0	281,4	243,6	138,6	-
700	483,0	460,0	432,4	404,8	377,2	345,0	308,2	266,8	151,8	-
750	498,7	475,0	446,5	418,0	389,5	356,2	318,2	275,5	156,7	-
800	514,5	490,0	460,6	431,2	401,8	367,5	328,3	284,2	161,7	-
900	546,0	520,0	488,8	457,6	426,4	390,0	348,4	301,6	171,6	-
1000	572,2	545,0	512,3	479,6	446,9	408,7	365,1	316,1	179,8	-

Tabella B.3e. Portate dei conduttori con temperatura di isolamento 90°C secondo NFPA 79 – Ed. 2012 - Table 12.5.1

Table B.3e. Ampacities of conductors with 90°C insulation temperature according to NFPA 79 – Ed. 2012 - Table 12.5.1

Sezione del conduttore [AWG/kcmil] Size	Portata massima per conduttori in rame isolati [A], Temperatura dell'isolamento 90°C Allowable ampacities of insulated copper conductors [A] Insulation temperature 90°C									
	Temperatura ambiente Ta Ambient temperature Ta									
	21÷25°C	26÷30°C	31÷35°C	36÷40°C	41÷45°C	46÷50°C	51÷55°C	56÷60°C	61÷70°C	71÷80°C
30 AWG	0,5	0,5	0,4	0,4	0,4	0,3	0,3	0,2	0,1	-
28	0,8	0,8	0,7	0,7	0,6	0,6	0,5	0,4	0,2	-
26	1,0	1,0	0,9	0,8	0,8	0,7	0,6	0,5	0,3	-
24	2,1	2,0	1,8	1,7	1,6	1,5	1,3	1,1	0,6	-
22	3,1	3,0	2,8	2,6	2,4	2,2	2,0	1,7	0,9	-
20	5,2	5,0	4,7	4,4	4,1	3,7	3,3	2,9	1,6	-
18	14,7	14,0	13,1	12,3	11,4	10,5	9,3	8,1	4,6	-
16	18,9	18,0	16,9	15,8	14,7	13,5	12,0	10,4	5,9	-
14	26,2	25,0	23,5	22,0	20,5	18,7	16,7	14,5	8,2	-
12	31,5	30,0	28,2	26,4	24,6	22,5	20,1	17,4	9,9	-
10	42,0	40,0	37,6	35,2	32,8	30,0	26,8	23,2	13,2	-
8	57,7	55,0	51,7	48,4	45,1	41,2	36,8	31,9	18,1	-
6	78,7	75,0	70,5	66,0	61,5	56,2	50,2	43,5	24,7	-
4	99,7	95,0	89,3	83,6	77,9	71,2	63,6	55,1	31,3	-
3	115,5	110,0	103,4	96,8	90,2	82,5	73,7	63,8	36,3	-
2	136,5	130,0	122,2	114,4	106,6	97,5	87,1	75,4	42,9	-
1	157,5	150,0	141,0	132,0	123,0	112,5	100,5	87,0	49,5	-
1/0	178,5	170,0	159,8	149,6	139,4	127,5	113,9	98,6	56,1	-
2/0	204,7	195,0	183,3	171,6	159,9	146,2	130,6	113,1	64,3	-
3/0	236,2	225,0	211,5	198,0	184,5	168,7	150,7	130,5	74,2	-
4/0	273,0	260,0	244,4	228,8	213,2	195,0	174,2	150,8	85,8	-
250 kcmil	304,5	290,0	272,6	255,2	237,8	217,5	194,3	168,2	95,7	-
300	336,0	320,0	300,8	281,6	262,4	240,0	214,4	185,6	105,6	-
350	367,5	350,0	329,0	308,0	287,0	262,5	234,5	203,0	115,5	-
400	399,0	380,0	357,2	334,4	311,6	285,0	254,6	220,4	125,4	-
500	451,5	430,0	404,2	378,4	352,6	322,5	288,1	249,4	141,9	-
600	498,7	475,0	446,5	418,0	389,5	356,2	318,2	275,5	156,7	-
700	546,0	520,0	488,8	457,6	426,4	390,0	348,4	301,6	171,6	-
750	561,7	535,0	502,9	470,8	438,7	401,2	358,4	310,3	176,5	-
800	582,7	555,0	521,7	488,4	455,1	416,2	371,8	321,9	183,1	-
900	614,2	585,0	549,9	514,8	479,7	438,7	391,9	339,3	193,0	-
1000	645,7	615,0	578,1	541,2	504,3	461,2	412,0	356,7	202,9	-

Tabella B.3f. Portate dei conduttori con temperatura di isolamento 60°C secondo NFPA 79 – Ed. 2015-2018 - Table 12.5.1

Table B.3f. Ampacities of conductors with 60°C insulation temperature according to NFPA 79 – Ed. 2015-2018 - Table 12.5.1

Sezione del conduttore [AWG/kcmil] Size	Portata massima per conduttori in rame isolati [A], Temperatura dell'isolamento 60°C Allowable ampacities of insulated copper conductors [A] Insulation temperature 60°C									
	Temperatura ambiente Ta Ambient temperature Ta									
	21÷25°C	26÷30°C	31÷35°C	36÷40°C	41÷45°C	46÷50°C	51÷55°C	56÷60°C	61÷70°C	71÷80°C
30 AWG	-	-	-	-	-	-	-	-	-	-
28	-	-	-	-	-	-	-	-	-	-
26	-	-	-	-	-	-	-	-	-	-
24	2,1	2,0	1,8	1,6	1,4	1,1	0,8	-	-	-
22	3,1	3,0	2,7	2,4	2,1	1,7	1,2	-	-	-
20	5,2	5,0	4,5	4,1	3,5	2,9	2,0	-	-	-
18	7,3	7,0	6,3	5,7	4,9	4,0	2,8	-	-	-
16	10,5	10,0	9,1	8,2	7,1	5,8	4,1	-	-	-
14	21,0	20,0	18,2	16,4	14,2	11,6	8,2	-	-	-
12	26,2	25,0	22,7	20,5	17,7	14,5	10,2	-	-	-
10	31,5	30,0	27,3	24,6	21,3	17,4	12,3	-	-	-
8	42,0	40,0	36,4	32,8	28,4	23,2	16,4	-	-	-
6	57,7	55,0	50,0	45,1	39,0	31,9	22,5	-	-	-
4	73,5	70,0	63,7	57,4	49,7	40,6	28,7	-	-	-
3	89,2	85,0	77,3	69,7	60,3	49,3	34,8	-	-	-
2	99,7	95,0	86,4	77,9	67,4	55,1	38,9	-	-	-
1	115,5	110,0	100,1	90,2	78,1	63,8	45,1	-	-	-
1/0	131,2	125,0	113,7	102,5	88,7	72,5	51,2	-	-	-
2/0	152,2	145,0	131,9	118,9	102,9	84,1	59,4	-	-	-
3/0	173,2	165,0	150,1	135,3	117,1	95,7	67,6	-	-	-
4/0	204,7	195,0	177,4	159,9	138,4	113,1	79,9	-	-	-
250 kcmil	225,7	215,0	195,6	176,3	152,6	124,7	88,1	-	-	-
300	252,0	240,0	218,4	196,8	170,4	139,2	98,4	-	-	-
350	273,0	260,0	236,6	213,2	184,6	150,8	106,6	-	-	-
400	294,0	280,0	254,8	229,6	198,8	162,4	114,8	-	-	-
500	336,0	320,0	291,2	262,4	227,2	185,6	131,2	-	-	-
600	372,7	355,0	323,0	291,1	252,0	205,9	145,5	-	-	-
700	404,2	385,0	350,3	315,7	273,3	223,3	157,8	-	-	-
750	420,0	400,0	364,0	328,0	284,0	232,0	164,0	-	-	-
800	430,5	410,0	373,1	336,2	291,1	237,8	168,1	-	-	-
900	456,7	435,0	395,8	356,7	308,8	252,3	178,3	-	-	-
1000	477,7	455,0	414,0	373,1	323,0	263,9	186,5	-	-	-

Tabella B.3g. Portate dei conduttori con temperatura di isolamento 75°C secondo NFPA 79 – Ed. 2015-2018 - Table 12.5.1

Table B.3g. Ampacities of conductors with 75°C insulation temperature according to NFPA 79 – Ed. 2015-2018 - Table 12.5.1

Sezione del conduttore [AWG/kcmil] Size	Portata massima per conduttori in rame isolati [A], Temperatura dell'isolamento 75°C Allowable ampacities of insulated copper conductors [A] Insulation temperature 75°C									
	Temperatura ambiente Ta Ambient temperature Ta									
	21÷25°C	26÷30°C	31÷35°C	36÷40°C	41÷45°C	46÷50°C	51÷55°C	56÷60°C	61÷70°C	71÷80°C
30 AWG	0,5	0,5	0,4	0,4	0,4	0,3	0,3	0,2	0,1	-
28	0,8	0,8	0,7	0,7	0,6	0,6	0,5	0,4	0,2	-
26	1,0	1,0	0,9	0,8	0,8	0,7	0,6	0,5	0,3	-
24	2,1	2,0	1,8	1,7	1,6	1,5	1,3	1,1	0,6	-
22	3,1	3,0	2,8	2,6	2,4	2,2	2,0	1,7	0,9	-
20	5,2	5,0	4,7	4,4	4,1	3,7	3,3	2,9	1,6	-
18	7,3	7,0	6,5	6,1	5,7	5,2	4,6	4,0	2,3	-
16	10,5	10,0	9,4	8,8	8,2	7,5	6,7	5,8	3,3	-
14	21,0	20,0	18,8	17,6	16,4	15,0	13,4	11,6	6,6	-
12	26,2	25,0	23,5	22,0	20,5	18,7	16,7	14,5	8,2	-
10	36,7	35,0	32,9	30,8	28,7	26,2	23,4	20,3	11,5	-
8	52,5	50,0	47,0	44,0	41,0	37,5	33,5	29,0	16,5	-
6	68,2	65,0	61,1	57,2	53,3	48,7	43,5	37,7	21,4	-
4	89,2	85,0	79,9	74,8	69,7	63,7	56,9	49,3	28,0	-
3	105,0	100,0	94,0	88,0	82,0	75,0	67,0	58,0	33,0	-
2	120,7	115,0	108,1	101,2	94,3	86,2	77,0	66,7	37,9	-
1	136,5	130,0	122,2	114,4	106,6	97,5	87,1	75,4	42,9	-
1/0	157,5	150,0	141,0	132,0	123,0	112,5	100,5	87,0	49,5	-
2/0	183,7	175,0	164,5	154,0	143,5	131,2	117,2	101,5	57,7	-
3/0	210,0	200,0	188,0	176,0	164,0	150,0	134,0	116,0	66,0	-
4/0	241,5	230,0	216,2	202,4	188,6	172,5	154,1	133,4	75,9	-
250 kcmil	267,7	255,0	239,7	224,4	209,1	191,2	170,8	147,9	84,1	-
300	299,2	285,0	267,9	250,8	233,7	213,7	190,9	165,3	94,0	-
350	325,5	310,0	291,4	272,8	254,2	232,5	207,7	179,8	102,3	-
400	351,7	335,0	314,9	294,8	274,7	251,2	224,4	194,3	110,5	-
500	399,0	380,0	357,2	334,4	311,6	285,0	254,6	220,4	125,4	-
600	441,0	420,0	394,8	369,6	344,4	315,0	281,4	243,6	138,6	-
700	483,0	460,0	432,4	404,8	377,2	345,0	308,2	266,8	151,8	-
750	498,7	475,0	446,5	418,0	389,5	356,2	318,2	275,5	156,7	-
800	514,5	490,0	460,6	431,2	401,8	367,5	328,3	284,2	161,7	-
900	546,0	520,0	488,8	457,6	426,4	390,0	348,4	301,6	171,6	-
1000	572,2	545,0	512,3	479,6	446,9	408,7	365,1	316,1	179,8	-

Tabella B.3h. Portate dei conduttori con temperatura di isolamento 90°C secondo NFPA 79 – Ed. 2015-2018 - Table 12.5.1

Table B.3h. Ampacities of conductors with 90°C insulation temperature according to NFPA 79 – Ed. 2015-2018 - Table 12.5.1

Sezione del conduttore [AWG/kcmil] Size	Portata massima per conduttori in rame isolati [A], Temperatura dell'isolamento 90°C Allowable ampacities of insulated copper conductors [A] Insulation temperature 90°C									
	Temperatura ambiente Ta Ambient temperature Ta									
	21÷25°C	26÷30°C	31÷35°C	36÷40°C	41÷45°C	46÷50°C	51÷55°C	56÷60°C	61÷70°C	71÷80°C
30 AWG	0,5	0,5	0,4	0,4	0,4	0,4	0,3	0,3	0,2	0,2
28	0,8	0,8	0,7	0,7	0,6	0,6	0,6	0,5	0,4	0,3
26	1,0	1,0	0,9	0,9	0,8	0,8	0,7	0,7	0,5	0,4
24	2,0	2,0	1,9	1,8	1,7	1,6	1,5	1,4	1,1	0,8
22	3,1	3,0	2,8	2,7	2,6	2,4	2,2	2,1	1,7	1,2
20	5,2	5,0	4,8	4,5	4,3	4,1	3,8	3,5	2,9	2,0
18	14,5	14,0	13,4	12,7	12,1	11,4	10,6	9,9	8,1	5,7
16	18,7	18,0	17,2	16,3	15,6	14,7	13,6	12,7	10,4	7,3
14	26,0	25,0	24,0	22,7	21,7	20,5	19,0	17,7	14,5	10,2
12	31,2	30,0	28,8	27,3	26,1	24,6	22,8	21,3	17,4	12,3
10	41,6	40,0	38,4	36,4	34,8	32,8	30,4	28,4	23,2	16,4
8	57,2	55,0	52,8	50,0	47,8	45,1	41,8	39,0	31,9	22,5
6	78,0	75,0	72,0	68,2	65,2	61,5	57,0	53,2	43,5	30,7
4	98,8	95,0	91,2	86,4	82,6	77,9	72,2	67,4	55,1	38,9
3	114,4	110,0	105,6	100,1	95,7	90,2	83,6	78,1	63,8	45,1
2	135,2	130,0	124,8	118,3	113,1	106,6	98,8	92,3	75,4	53,3
1	156,0	150,0	144,0	136,5	130,5	123,0	114,0	106,5	87,0	61,5
1/0	176,8	170,0	163,2	154,7	147,9	139,4	129,2	120,7	98,6	69,7
2/0	202,8	195,0	187,2	177,4	169,6	159,9	148,2	138,4	113,1	79,9
3/0	234,0	225,0	216,0	204,7	195,7	184,5	171,0	159,7	130,5	92,2
4/0	270,4	260,0	249,6	236,6	226,2	213,2	197,6	184,6	150,8	106,6
250 kcmil	301,6	290,0	278,4	263,9	252,3	237,8	220,4	205,9	168,2	118,9
300	332,8	320,0	307,2	291,2	278,4	262,4	243,2	227,2	185,6	131,2
350	364,0	350,0	336,0	318,5	304,5	287,0	266,0	248,5	203,0	143,5
400	395,2	380,0	364,8	345,8	330,6	311,6	288,8	269,8	220,4	155,8
500	447,2	430,0	412,8	391,3	374,1	352,6	326,8	305,3	249,4	176,3
600	494,0	475,0	456,0	432,2	413,2	389,5	361,0	337,2	275,5	194,7
700	540,8	520,0	499,2	473,2	452,4	426,4	395,2	369,2	301,6	213,2
750	556,4	535,0	513,6	486,8	465,4	438,7	406,6	379,8	310,3	219,3
800	577,2	555,0	532,8	505,0	482,8	455,1	421,8	394,0	321,9	227,5
900	608,4	585,0	561,6	532,3	508,9	479,7	444,6	415,3	339,3	239,8
1000	639,6	615,0	590,4	559,6	535,0	504,3	467,4	436,6	356,7	252,1

Tabella B.3i. Portate dei conduttori con temperatura di isolamento 60°C secondo NFPA 79 – Ed. 2021 - Table 12.5.1

Table B.3i. Ampacities of conductors with 60°C insulation temperature according to NFPA 79 – Ed. 2021 - Table 12.5.1

Sezione del conduttore [AWG/kcmil] Size	Portata massima per conduttori in rame isolati [A], Temperatura dell'isolamento 60°C Allowable ampacities of insulated copper conductors [A] Insulation temperature 60°C									
	Temperatura ambiente Ta Ambient temperature Ta									
	21÷25°C	26÷30°C	31÷35°C	36÷40°C	41÷45°C	46÷50°C	51÷55°C	56÷60°C	61÷70°C	71÷80°C
30 AWG	-	-	-	-	-	-	-	-	-	-
28	-	-	-	-	-	-	-	-	-	-
26	-	-	-	-	-	-	-	-	-	-
24	2,1	2,0	1,8	1,6	1,4	1,1	0,8	-	-	-
22	3,1	3,0	2,7	2,4	2,1	1,7	1,2	-	-	-
20	5,2	5,0	4,5	4,1	3,5	2,9	2,0	-	-	-
18	7,3	7,0	6,3	5,7	4,9	4,0	2,8	-	-	-
16	10,5	10,0	9,1	8,2	7,1	5,8	4,1	-	-	-
14	15,7	15,0	13,6	12,3	10,6	8,7	6,1	-	-	-
12	21,0	20,0	18,2	16,4	14,2	11,6	8,2	-	-	-
10	31,5	30,0	27,3	24,6	21,3	17,4	12,3	-	-	-
8	42,0	40,0	36,4	32,8	28,4	23,2	16,4	-	-	-
6	57,7	55,0	50,0	45,1	39,0	31,9	22,5	-	-	-
4	73,5	70,0	63,7	57,4	49,7	40,6	28,7	-	-	-
3	89,2	85,0	77,3	69,7	60,3	49,3	34,8	-	-	-
2	99,7	95,0	86,4	77,9	67,4	55,1	38,9	-	-	-
1	115,5	110,0	100,1	90,2	78,1	63,8	45,1	-	-	-
1/0	131,2	125,0	113,7	102,5	88,7	72,5	51,2	-	-	-
2/0	152,2	145,0	131,9	118,9	102,9	84,1	59,4	-	-	-
3/0	173,2	165,0	150,1	135,3	117,1	95,7	67,6	-	-	-
4/0	204,7	195,0	177,4	159,9	138,4	113,1	79,9	-	-	-
250 kcmil	225,7	215,0	195,6	176,3	152,6	124,7	88,1	-	-	-
300	252,0	240,0	218,4	196,8	170,4	139,2	98,4	-	-	-
350	273,0	260,0	236,6	213,2	184,6	150,8	106,6	-	-	-
400	294,0	280,0	254,8	229,6	198,8	162,4	114,8	-	-	-
500	336,0	320,0	291,2	262,4	227,2	185,6	131,2	-	-	-
600	372,7	355,0	323,0	291,1	252,0	205,9	145,5	-	-	-
700	404,2	385,0	350,3	315,7	273,3	223,3	157,8	-	-	-
750	420,0	400,0	364,0	328,0	284,0	232,0	164,0	-	-	-
800	430,5	410,0	373,1	336,2	291,1	237,8	168,1	-	-	-
900	456,7	435,0	395,8	356,7	308,8	252,3	178,3	-	-	-
1000	477,7	455,0	414,0	373,1	323,0	263,9	186,5	-	-	-

Tabella B.3j. Portate dei conduttori con temperatura di isolamento 75°C secondo NFPA 79 – Ed. 2021 - Table 12.5.1

Table B.3j. Ampacities of conductors with 75°C insulation temperature according to NFPA 79 – Ed. 2021 - Table 12.5.1

Sezione del conduttore [AWG/kcmil] Size	Portata massima per conduttori in rame isolati [A], Temperatura dell'isolamento 75°C Allowable ampacities of insulated copper conductors [A] Insulation temperature 75°C									
	Temperatura ambiente Ta Ambient temperature Ta									
	21÷25°C	26÷30°C	31÷35°C	36÷40°C	41÷45°C	46÷50°C	51÷55°C	56÷60°C	61÷70°C	71÷80°C
30 AWG	0,5	0,5	0,4	0,4	0,4	0,3	0,3	0,2	0,1	-
28	0,8	0,8	0,7	0,7	0,6	0,6	0,5	0,4	0,2	-
26	1,0	1,0	0,9	0,8	0,8	0,7	0,6	0,5	0,3	-
24	2,1	2,0	1,8	1,7	1,6	1,5	1,3	1,1	0,6	-
22	3,1	3,0	2,8	2,6	2,4	2,2	2,0	1,7	0,9	-
20	5,2	5,0	4,7	4,4	4,1	3,7	3,3	2,9	1,6	-
18	7,3	7,0	6,5	6,1	5,7	5,2	4,6	4,0	2,3	-
16	10,5	10,0	9,4	8,8	8,2	7,5	6,7	5,8	3,3	-
14	21,0	20,0	18,8	17,6	16,4	15,0	13,4	11,6	6,6	-
12	26,2	25,0	23,5	22,0	20,5	18,7	16,7	14,5	8,2	-
10	36,7	35,0	32,9	30,8	28,7	26,2	23,4	20,3	11,5	-
8	52,5	50,0	47,0	44,0	41,0	37,5	33,5	29,0	16,5	-
6	68,2	65,0	61,1	57,2	53,3	48,7	43,5	37,7	21,4	-
4	89,2	85,0	79,9	74,8	69,7	63,7	56,9	49,3	28,0	-
3	105,0	100,0	94,0	88,0	82,0	75,0	67,0	58,0	33,0	-
2	120,7	115,0	108,1	101,2	94,3	86,2	77,0	66,7	37,9	-
1	136,5	130,0	122,2	114,4	106,6	97,5	87,1	75,4	42,9	-
1/0	157,5	150,0	141,0	132,0	123,0	112,5	100,5	87,0	49,5	-
2/0	183,7	175,0	164,5	154,0	143,5	131,2	117,2	101,5	57,7	-
3/0	210,0	200,0	188,0	176,0	164,0	150,0	134,0	116,0	66,0	-
4/0	241,5	230,0	216,2	202,4	188,6	172,5	154,1	133,4	75,9	-
250 kcmil	267,7	255,0	239,7	224,4	209,1	191,2	170,8	147,9	84,1	-
300	299,2	285,0	267,9	250,8	233,7	213,7	190,9	165,3	94,0	-
350	325,5	310,0	291,4	272,8	254,2	232,5	207,7	179,8	102,3	-
400	351,7	335,0	314,9	294,8	274,7	251,2	224,4	194,3	110,5	-
500	399,0	380,0	357,2	334,4	311,6	285,0	254,6	220,4	125,4	-
600	441,0	420,0	394,8	369,6	344,4	315,0	281,4	243,6	138,6	-
700	483,0	460,0	432,4	404,8	377,2	345,0	308,2	266,8	151,8	-
750	498,7	475,0	446,5	418,0	389,5	356,2	318,2	275,5	156,7	-
800	514,5	490,0	460,6	431,2	401,8	367,5	328,3	284,2	161,7	-
900	546,0	520,0	488,8	457,6	426,4	390,0	348,4	301,6	171,6	-
1000	572,2	545,0	512,3	479,6	446,9	408,7	365,1	316,1	179,8	-

Tabella B.3k. Portate dei conduttori con temperatura di isolamento 90°C secondo NFPA 79 – Ed. 2021 - Table 12.5.1

Table B.3k. Ampacities of conductors with 90°C insulation temperature according to NFPA 79 – Ed. 2021 - Table 12.5.1

Sezione del conduttore [AWG/kcmil] Size	Portata massima per conduttori in rame isolati [A], Temperatura dell'isolamento 90°C Allowable ampacities of insulated copper conductors [A] Insulation temperature 90°C									
	Temperatura ambiente Ta Ambient temperature Ta									
	21÷25°C	26÷30°C	31÷35°C	36÷40°C	41÷45°C	46÷50°C	51÷55°C	56÷60°C	61÷70°C	71÷80°C
30 AWG	0,5	0,5	0,4	0,4	0,4	0,4	0,3	0,3	0,2	0,2
28	0,8	0,8	0,7	0,7	0,6	0,6	0,6	0,5	0,4	0,3
26	1,0	1,0	0,9	0,9	0,8	0,8	0,7	0,7	0,5	0,4
24	2,0	2,0	1,9	1,8	1,7	1,6	1,5	1,4	1,1	0,8
22	3,1	3,0	2,8	2,7	2,6	2,4	2,2	2,1	1,7	1,2
20	5,2	5,0	4,8	4,5	4,3	4,1	3,8	3,5	2,9	2,0
18	14,5	14,0	13,4	12,7	12,1	11,4	10,6	9,9	8,1	5,7
16	18,7	18,0	17,2	16,3	15,6	14,7	13,6	12,7	10,4	7,3
14	26,0	25,0	24,0	22,7	21,7	20,5	19,0	17,7	14,5	10,2
12	31,2	30,0	28,8	27,3	26,1	24,6	22,8	21,3	17,4	12,3
10	41,6	40,0	38,4	36,4	34,8	32,8	30,4	28,4	23,2	16,4
8	57,2	55,0	52,8	50,0	47,8	45,1	41,8	39,0	31,9	22,5
6	78,0	75,0	72,0	68,2	65,2	61,5	57,0	53,2	43,5	30,7
4	98,8	95,0	91,2	86,4	82,6	77,9	72,2	67,4	55,1	38,9
3	119,6	115,0	110,4	104,6	100,0	94,3	87,4	81,6	66,7	47,1
2	135,2	130,0	124,8	118,3	113,1	106,6	98,8	92,3	75,4	53,3
1	150,8	145,0	139,2	131,9	126,1	118,9	110,2	102,9	84,1	59,4
1/0	176,8	170,0	163,2	154,7	147,9	139,4	129,2	120,7	98,6	69,7
2/0	202,8	195,0	187,2	177,4	169,6	159,9	148,2	138,4	113,1	79,9
3/0	234,0	225,0	216,0	204,7	195,7	184,5	171,0	159,7	130,5	92,2
4/0	270,4	260,0	249,6	236,6	226,2	213,2	197,6	184,6	150,8	106,6
250 kcmil	301,6	290,0	278,4	263,9	252,3	237,8	220,4	205,9	168,2	118,9
300	332,8	320,0	307,2	291,2	278,4	262,4	243,2	227,2	185,6	131,2
350	364,0	350,0	336,0	318,5	304,5	287,0	266,0	248,5	203,0	143,5
400	395,2	380,0	364,8	345,8	330,6	311,6	288,8	269,8	220,4	155,8
500	447,2	430,0	412,8	391,3	374,1	352,6	326,8	305,3	249,4	176,3
600	494,0	475,0	456,0	432,2	413,2	389,5	361,0	337,2	275,5	194,7
700	540,8	520,0	499,2	473,2	452,4	426,4	395,2	369,2	301,6	213,2
750	556,4	535,0	513,6	486,8	465,4	438,7	406,6	379,8	310,3	219,3
800	577,2	555,0	532,8	505,0	482,8	455,1	421,8	394,0	321,9	227,5
900	608,4	585,0	561,6	532,3	508,9	479,7	444,6	415,3	339,3	239,8
1000	639,6	615,0	590,4	559,6	535,0	504,3	467,4	436,6	356,7	252,1

Tabella B.3l. Fattori di correzione delle portate in funzione del numero di conduttori alimentati secondo NFPA 79 - Ed. 2007-2021 - Table 12.5.5(b)

Table B.3l. Adjustment factors based on the number of current-carrying conductors according to NFPA 79 - Ed. 2007-2021 - Table 12.5.5(b)

Numero di conduttori alimentati in canalina o in cavo Number of current-carrying conductors	Coefficiente di correzione della portata massima Ampacities adjustment factors
1÷3	1,00
4÷6	0,80
7÷9	0,70
10÷20	0,50
21÷30	0,45
31÷40	0,40
>40	0,35

B.4 Portate dei conduttori secondo NFPA 70 (NEC) Ampacities of conductors according to NFPA 70 (NEC)

Le tabelle mostrano le portate dei conduttori pubblicate nella norma alla quale si deve fare sempre riferimento.

The tables show the ampacities of the conductors published in the standard to which reference must always be made.

Tabella B.4a. Portate dei conduttori con temperatura dell'isolamento 60°C secondo NFPA 70 (NEC) – Ed. 2008 - Table 310.16

Table B.4a. Ampacities of conductors with 60°C insulation temperature according to NFPA 70 (NEC) - Ed. 2008 - Table 310.16

Sezione del conduttore Conductor's size [AWG/kcmil]	Portata massima per conduttori in rame isolati [A], posizionati in canalina o in cavo, non più di tre conduttori alimentati Temperatura dell'isolamento 60°C Allowable ampacities of insulated copper conductors [A], not more than three current-carrying conductors in Raceway or Cable Insulation temperature 60°C									
	Temperatura ambiente Ta Ambient temperature Ta									
	21÷25°C	26÷30°C	31÷35°C	36÷40°C	41÷45°C	46÷50°C	51÷55°C	56÷60°C	61÷70°C	71÷80°C
18 AWG	-	-	-	-	-	-	-	-	-	-
16	-	-	-	-	-	-	-	-	-	-
14	21,6	20,0	18,2	16,4	14,2	11,6	8,2	-	-	-
12	27,0	25,0	22,7	20,5	17,7	14,5	10,2	-	-	-
10	32,4	30,0	27,3	24,6	21,3	17,4	12,3	-	-	-
8	43,2	40,0	36,4	32,8	28,4	23,2	16,4	-	-	-
6	59,4	55,0	50,0	45,1	39,0	31,9	22,5	-	-	-
4	75,6	70,0	63,7	57,4	49,7	40,6	28,7	-	-	-
3	91,8	85,0	77,3	69,7	60,3	49,3	34,8	-	-	-
2	102,6	95,0	86,4	77,9	67,4	55,1	38,9	-	-	-
1	118,8	110,0	100,1	90,2	78,1	63,8	45,1	-	-	-
1/0	135,0	125,0	113,7	102,5	88,7	72,5	51,2	-	-	-
2/0	156,6	145,0	131,9	118,9	102,9	84,1	59,4	-	-	-
3/0	178,2	165,0	150,1	135,3	117,1	95,7	67,6	-	-	-
4/0	210,6	195,0	177,4	159,9	138,4	113,1	79,9	-	-	-
250 kcmil	232,2	215,0	195,6	176,3	152,6	124,7	88,1	-	-	-
300	259,2	240,0	218,4	196,8	170,4	139,2	98,4	-	-	-
350	280,8	260,0	236,6	213,2	184,6	150,8	106,6	-	-	-
400	302,4	280,0	254,8	229,6	198,8	162,4	114,8	-	-	-
500	345,6	320,0	291,2	262,4	227,2	185,6	131,2	-	-	-
600	383,4	355,0	323,0	291,1	252,0	205,9	145,5	-	-	-
700	415,8	385,0	350,3	315,7	273,3	223,3	157,8	-	-	-
750	432,0	400,0	364,0	328,0	284,0	232,0	164,0	-	-	-
800	442,8	410,0	373,1	336,2	291,1	237,8	168,1	-	-	-
900	469,8	435,0	395,8	356,7	308,8	252,3	178,3	-	-	-
1000	491,4	455,0	414,0	373,1	323,0	263,9	186,5	-	-	-
1250	534,6	495,0	450,4	405,9	351,4	287,1	202,9	-	-	-
1500	561,6	520,0	473,2	426,4	369,2	301,6	213,2	-	-	-
1750	588,6	545,0	495,9	446,9	386,9	316,1	223,4	-	-	-
2000	604,8	560,0	509,6	459,2	397,6	324,8	229,6	-	-	-

Tabella B.4b. Portate dei conduttori con temperatura dell'isolamento 75°C secondo NFPA 70 (NEC) – Ed. 2008 - Table 310.16

Table B.4b. Ampacities of conductors with 75°C insulation temperature according to NFPA 70 (NEC) - Ed. 2008 - Table 310.16

Sezione del conduttore Conductor's size [AWG/kcmil]	Portata massima per conduttori in rame isolati [A], posizionati in canalina o in cavo, non più di tre conduttori alimentati Temperatura dell'isolamento 75°C Allowable ampacities of insulated copper conductors [A], not more than three current-carrying conductors in Raceway or Cable Insulation temperature 75°C									
	Temperatura ambiente Ta Ambient temperature Ta									
	21÷25°C	26÷30°C	31÷35°C	36÷40°C	41÷45°C	46÷50°C	51÷55°C	56÷60°C	61÷70°C	71÷80°C
18 AWG	-	-	-	-	-	-	-	-	-	-
16	-	-	-	-	-	-	-	-	-	-
14	21,0	20,0	18,8	17,6	16,4	15,0	13,4	11,6	6,6	-
12	26,2	25,0	23,5	22,0	20,5	18,7	16,7	14,5	8,2	-
10	36,7	35,0	32,9	30,8	28,7	26,2	23,4	20,3	11,5	-
8	52,5	50,0	47,0	44,0	41,0	37,5	33,5	29,0	16,5	-
6	68,2	65,0	61,1	57,2	53,3	48,7	43,5	37,7	21,4	-
4	89,2	85,0	79,9	74,8	69,7	63,7	56,9	49,3	28,0	-
3	105,0	100,0	94,0	88,0	82,0	75,0	67,0	58,0	33,0	-
2	120,7	115,0	108,1	101,2	94,3	86,2	77,0	66,7	37,9	-
1	136,5	130,0	122,2	114,4	106,6	97,5	87,1	75,4	42,9	-
1/0	157,5	150,0	141,0	132,0	123,0	112,5	100,5	87,0	49,5	-
2/0	183,7	175,0	164,5	154,0	143,5	131,2	117,2	101,5	57,7	-
3/0	210,0	200,0	188,0	176,0	164,0	150,0	134,0	116,0	66,0	-
4/0	241,5	230,0	216,2	202,4	188,6	172,5	154,1	133,4	75,9	-
250 kcmil	267,7	255,0	239,7	224,4	209,1	191,2	170,8	147,9	84,1	-
300	299,2	285,0	267,9	250,8	233,7	213,7	190,9	165,3	94,0	-
350	325,5	310,0	291,4	272,8	254,2	232,5	207,7	179,8	102,3	-
400	351,7	335,0	314,9	294,8	274,7	251,2	224,4	194,3	110,5	-
500	399,0	380,0	357,2	334,4	311,6	285,0	254,6	220,4	125,4	-
600	441,0	420,0	394,8	369,6	344,4	315,0	281,4	243,6	138,6	-
700	483,0	460,0	432,4	404,8	377,2	345,0	308,2	266,8	151,8	-
750	498,7	475,0	446,5	418,0	389,5	356,2	318,2	275,5	156,7	-
800	514,5	490,0	460,6	431,2	401,8	367,5	328,3	284,2	161,7	-
900	546,0	520,0	488,8	457,6	426,4	390,0	348,4	301,6	171,6	-
1000	572,2	545,0	512,3	479,6	446,9	408,7	365,1	316,1	179,8	-
1250	619,5	590,0	554,6	519,2	483,8	442,5	395,3	342,2	194,7	-
1500	656,2	625,0	587,5	550,0	512,5	468,7	418,7	362,5	206,2	-
1750	682,5	650,0	611,0	572,0	533,0	487,5	435,5	377,0	214,5	-
2000	698,2	665,0	625,1	585,2	545,3	498,7	445,5	385,7	219,4	-

Tabella B.4c. Portate dei conduttori con temperatura dell'isolamento 90°C secondo NFPA 70 (NEC) – Ed. 2008 - Table 310.16

Table B.4c. Ampacities of conductors with 90°C insulation temperature according to NFPA 70 (NEC) - Ed. 2008 - Table 310.16

Sezione del conduttore Conductor's size [AWG/kcmil]	Portata massima per conduttori in rame isolati [A], posizionati in canalina o in cavo, non più di tre conduttori alimentati Temperatura dell'isolamento 90°C Allowable ampacities of insulated copper conductors [A], not more than three current-carrying conductors in Raceway or Cable Insulation temperature 90°C										
	Temperatura ambiente Ta Ambient temperature Ta										
	21÷25°C	26÷30°C	31÷35°C	36÷40°C	41÷45°C	46÷50°C	51÷55°C	56÷60°C	61÷70°C	71÷80°C	
18 AWG	14,5	14,0	13,4	12,7	12,1	11,4	10,6	9,9	8,1	5,7	
16	18,7	18,0	17,2	16,3	15,6	14,7	13,6	12,7	10,4	7,3	
14	26,0	25,0	24,0	22,7	21,7	20,5	19,0	17,7	14,5	10,2	
12	31,2	30,0	28,8	27,3	26,1	24,6	22,8	21,3	17,4	12,3	
10	41,6	40,0	38,4	36,4	34,8	32,8	30,4	28,4	23,2	16,4	
8	57,2	55,0	52,8	50,0	47,8	45,1	41,8	39,0	31,9	22,5	
6	78,0	75,0	72,0	68,2	65,2	61,5	57,0	53,2	43,5	30,7	
4	98,8	95,0	91,2	86,4	82,6	77,9	72,2	67,4	55,1	38,9	
3	114,4	110,0	105,6	100,1	95,7	90,2	83,6	78,1	63,8	45,1	
2	135,2	130,0	124,8	118,3	113,1	106,6	98,8	92,3	75,4	53,3	
1	156,0	150,0	144,0	136,5	130,5	123,0	114,0	106,5	87,0	61,5	
1/0	176,8	170,0	163,2	154,7	147,9	139,4	129,2	120,7	98,6	69,7	
2/0	202,8	195,0	187,2	177,4	169,6	159,9	148,2	138,4	113,1	79,9	
3/0	234,0	225,0	216,0	204,7	195,7	184,5	171,0	159,7	130,5	92,2	
4/0	270,4	260,0	249,6	236,6	226,2	213,2	197,6	184,6	150,8	106,6	
250 kcmil	301,6	290,0	278,4	263,9	252,3	237,8	220,4	205,9	168,2	118,9	
300	332,8	320,0	307,2	291,2	278,4	262,4	243,2	227,2	185,6	131,2	
350	364,0	350,0	336,0	318,5	304,5	287,0	266,0	248,5	203,0	143,5	
400	395,2	380,0	364,8	345,8	330,6	311,6	288,8	269,8	220,4	155,8	
500	447,2	430,0	412,8	391,3	374,1	352,6	326,8	305,3	249,4	176,3	
600	494,0	475,0	456,0	432,2	413,2	389,5	361,0	337,2	275,5	194,7	
700	540,8	520,0	499,2	473,2	452,4	426,4	395,2	369,2	301,6	213,2	
750	556,4	535,0	513,6	486,8	465,4	438,7	406,6	379,8	310,3	219,3	
800	577,2	555,0	532,8	505,0	482,8	455,1	421,8	394,0	321,9	227,5	
900	608,4	585,0	561,6	532,3	508,9	479,7	444,6	415,3	339,3	239,8	
1000	639,6	615,0	590,4	559,6	535,0	504,3	467,4	436,6	356,7	252,1	
1250	691,6	665,0	638,4	605,1	578,5	545,3	505,4	472,1	385,7	272,6	
1500	733,2	705,0	676,8	641,5	613,3	578,1	535,8	500,5	408,9	289,0	
1750	764,4	735,0	705,6	668,8	639,4	602,7	558,6	521,8	426,3	301,3	
2000	780,0	750,0	720,0	682,5	652,5	615,0	570,0	532,5	435,0	307,5	

Tabella B.4d. Portate dei conduttori con temperatura dell'isolamento 60°C secondo NFPA 70 (NEC) – Ed. 2011-2017 - Table 310.15(B)(16) e Ed. 2020-2023 - Table 310.16
 Table B.4d. Ampacities of conductors with 60°C insulation temperature according to NFPA 70 (NEC) - Ed. 2011-2017 - Table 310.15(B)(16) and Ed. 2020-2023 - Table 310.16

Sezione del conduttore Conductor's size [AWG/kcmil]	Portata massima per conduttori in rame isolati [A], posizionati in canalina o in cavo, non più di tre conduttori alimentati Temperatura dell'isolamento 60°C Allowable ampacities of insulated copper conductors [A], not more than three current-carrying conductors in Raceway or Cable Insulation temperature 60°C												
	Temperatura ambiente Ta Ambient temperature Ta												
	21÷25°C	26÷30°C	31÷35°C	36÷40°C	41÷45°C	46÷50°C	51÷55°C	56÷60°C	61÷65°C	66÷70°C	71÷75°C	76÷80°C	81-85°C
18 AWG	-	-	-	-	-	-	-	-	-	-	-	-	-
16	-	-	-	-	-	-	-	-	-	-	-	-	-
14	16,2	15,0	13,6	12,3	10,6	8,7	6,1	-	-	-	-	-	-
12	21,6	20,0	18,2	16,4	14,2	11,6	8,2	-	-	-	-	-	-
10	32,4	30,0	27,3	24,6	21,3	17,4	12,3	-	-	-	-	-	-
8	43,2	40,0	36,4	32,8	28,4	23,2	16,4	-	-	-	-	-	-
6	59,4	55,0	50,0	45,1	39,0	31,9	22,5	-	-	-	-	-	-
4	75,6	70,0	63,7	57,4	49,7	40,6	28,7	-	-	-	-	-	-
3	91,8	85,0	77,3	69,7	60,3	49,3	34,8	-	-	-	-	-	-
2	102,6	95,0	86,4	77,9	67,4	55,1	38,9	-	-	-	-	-	-
1	118,8	110,0	100,1	90,2	78,1	63,8	45,1	-	-	-	-	-	-
1/0	135,0	125,0	113,7	102,5	88,7	72,5	51,2	-	-	-	-	-	-
2/0	156,6	145,0	131,9	118,9	102,9	84,1	59,4	-	-	-	-	-	-
3/0	178,2	165,0	150,1	135,3	117,1	95,7	67,6	-	-	-	-	-	-
4/0	210,6	195,0	177,4	159,9	138,4	113,1	79,9	-	-	-	-	-	-
250 kcmil	232,2	215,0	195,6	176,3	152,6	124,7	88,1	-	-	-	-	-	-
300	259,2	240,0	218,4	196,8	170,4	139,2	98,4	-	-	-	-	-	-
350	280,8	260,0	236,6	213,2	184,6	150,8	106,6	-	-	-	-	-	-
400	302,4	280,0	254,8	229,6	198,8	162,4	114,8	-	-	-	-	-	-
500	345,6	320,0	291,2	262,4	227,2	185,6	131,2	-	-	-	-	-	-
600	378,0	350,0	318,5	287,0	248,5	203,0	143,5	-	-	-	-	-	-
700	415,8	385,0	350,3	315,7	273,3	223,3	157,8	-	-	-	-	-	-
750	432,0	400,0	364,0	328,0	284,0	232,0	164,0	-	-	-	-	-	-
800	442,8	410,0	373,1	336,2	291,1	237,8	168,1	-	-	-	-	-	-
900	469,8	435,0	395,8	356,7	308,8	252,3	178,3	-	-	-	-	-	-
1000	491,4	455,0	414,0	373,1	323,0	263,9	186,5	-	-	-	-	-	-
1250	534,6	495,0	450,4	405,9	351,4	287,1	202,9	-	-	-	-	-	-
1500	567,0	525,0	477,7	430,5	372,7	304,5	215,2	-	-	-	-	-	-
1750	588,6	545,0	495,9	446,9	386,9	316,1	223,4	-	-	-	-	-	-
2000	599,4	555,0	505,0	455,1	394,0	321,9	227,5	-	-	-	-	-	-

Tabella B.4e. Portate dei conduttori con temperatura dell'isolamento 75°C secondo NFPA 70 (NEC) - Ed. 2011-2017 - Table 310.15(B)(16) e Ed. 2020-2023 - Table 310.16

Table B.4e. Ampacities of conductors with 75°C insulation temperature according to NFPA 70 (NEC) - Ed. 2011-2017 - Table 310.15(B)(16) and Ed. 2020-2023 - Table 310.16

Sezione del conduttore Conductor's size [AWG/kcmil]	Portata massima per conduttori in rame isolati [A], posizionati in canalina o in cavo, non più di tre conduttori alimentati Temperatura dell'isolamento 75°C Allowable ampacities of insulated copper conductors [A], not more than three current-carrying conductors in Raceway or Cable Insulation temperature 75°C												
	Temperatura ambiente Ta Ambient temperature Ta												
	21÷25°C	26÷30°C	31÷35°C	36÷40°C	41÷45°C	46÷50°C	51÷55°C	56÷60°C	61÷65°C	66÷70°C	71÷75°C	76÷80°C	81-85°C
18 AWG	-	-	-	-	-	-	-	-	-	-	-	-	-
16	-	-	-	-	-	-	-	-	-	-	-	-	-
14	21,0	20,0	18,8	17,6	16,4	15,0	13,4	11,6	9,4	6,6	-	-	-
12	26,2	25,0	23,5	22,0	20,5	18,7	16,7	14,5	11,7	8,2	-	-	-
10	36,7	35,0	32,9	30,8	28,7	26,2	23,4	20,3	16,4	11,5	-	-	-
8	52,5	50,0	47,0	44,0	41,0	37,5	33,5	29,0	23,5	16,5	-	-	-
6	68,2	65,0	61,1	57,2	53,3	48,7	43,5	37,7	30,5	21,4	-	-	-
4	89,2	85,0	79,9	74,8	69,7	63,7	56,9	49,3	39,9	28,0	-	-	-
3	105,0	100,0	94,0	88,0	82,0	75,0	67,0	58,0	47,0	33,0	-	-	-
2	120,7	115,0	108,1	101,2	94,3	86,2	77,0	66,7	54,0	37,9	-	-	-
1	136,5	130,0	122,2	114,4	106,6	97,5	87,1	75,4	61,1	42,9	-	-	-
1/0	157,5	150,0	141,0	132,0	123,0	112,5	100,5	87,0	70,5	49,5	-	-	-
2/0	183,7	175,0	164,5	154,0	143,5	131,2	117,2	101,5	82,2	57,7	-	-	-
3/0	210,0	200,0	188,0	176,0	164,0	150,0	134,0	116,0	94,0	66,0	-	-	-
4/0	241,5	230,0	216,2	202,4	188,6	172,5	154,1	133,4	108,1	75,9	-	-	-
250 kcmil	267,7	255,0	239,7	224,4	209,1	191,2	170,8	147,9	119,8	84,1	-	-	-
300	299,2	285,0	267,9	250,8	233,7	213,7	190,9	165,3	133,9	94,0	-	-	-
350	325,5	310,0	291,4	272,8	254,2	232,5	207,7	179,8	145,7	102,3	-	-	-
400	351,7	335,0	314,9	294,8	274,7	251,2	224,4	194,3	157,4	110,5	-	-	-
500	399,0	380,0	357,2	334,4	311,6	285,0	254,6	220,4	178,6	125,4	-	-	-
600	441,0	420,0	394,8	369,6	344,4	315,0	281,4	243,6	197,4	138,6	-	-	-
700	483,0	460,0	432,4	404,8	377,2	345,0	308,2	266,8	216,2	151,8	-	-	-
750	498,7	475,0	446,5	418,0	389,5	356,2	318,2	275,5	223,2	156,7	-	-	-
800	514,5	490,0	460,6	431,2	401,8	367,5	328,3	284,2	230,3	161,7	-	-	-
900	546,0	520,0	488,8	457,6	426,4	390,0	348,4	301,6	244,4	171,6	-	-	-
1000	572,2	545,0	512,3	479,6	446,9	408,7	365,1	316,1	256,1	179,8	-	-	-
1250	619,5	590,0	554,6	519,2	483,8	442,5	395,3	342,2	277,3	194,7	-	-	-
1500	656,2	625,0	587,5	550,0	512,5	468,7	418,7	362,5	293,7	206,2	-	-	-
1750	682,5	650,0	611,0	572,0	533,0	487,5	435,5	377,0	305,5	214,5	-	-	-
2000	698,2	665,0	625,1	585,2	545,3	498,7	445,5	385,7	312,5	219,4	-	-	-

Tabella B.4f. Portate dei conduttori con temperatura dell'isolamento 90°C secondo NFPA 70 (NEC) - Ed. 2011-2017 - Table 310.15(B)(16) e Ed. 2020-2023 - Table 310.16
 Table B.4f. Ampacities of conductors with 90°C insulation temperature according to NFPA 70 (NEC) - Ed. 2011-2017 - Table 310.15(B)(16) and Ed. 2020-2023 - Table 310.16

Sezione del conduttore Conductor's size [AWG/kcmil]	Portata massima per conduttori in rame isolati [A], posizionati in canalina o in cavo, non più di tre conduttori alimentati Temperatura dell'isolamento 90°C Allowable ampacities of insulated copper conductors [A], not more than three current-carrying conductors in Raceway or Cable Insulation temperature 90°C													
	Temperatura ambiente Ta Ambient temperature Ta													
	21÷25°C	26÷30°C	31÷35°C	36÷40°C	41÷45°C	46÷50°C	51÷55°C	56÷60°C	61÷65°C	66÷70°C	71÷75°C	76÷80°C	81-85°C	
18 AWG	14,5	14,0	13,4	12,7	12,1	11,4	10,6	9,9	9,1	8,1	7,0	5,7	4,0	
16	18,7	18,0	17,2	16,3	15,6	14,7	13,6	12,7	11,7	10,4	9,0	7,3	5,2	
14	26,0	25,0	24,0	22,7	21,7	20,5	19,0	17,7	16,2	14,5	12,5	10,2	7,2	
12	31,2	30,0	28,8	27,3	26,1	24,6	22,8	21,3	19,5	17,4	15,0	12,3	8,7	
10	41,6	40,0	38,4	36,4	34,8	32,8	30,4	28,4	26,0	23,2	20,0	16,4	11,6	
8	57,2	55,0	52,8	50,0	47,8	45,1	41,8	39,0	35,7	31,9	27,5	22,5	15,9	
6	78,0	75,0	72,0	68,2	65,2	61,5	57,0	53,2	48,7	43,5	37,5	30,7	21,7	
4	98,8	95,0	91,2	86,4	82,6	77,9	72,2	67,4	61,7	55,1	47,5	38,9	27,5	
3	119,6	115,0	110,4	104,6	100,0	94,3	87,4	81,6	74,7	66,7	57,5	47,1	33,3	
2	135,2	130,0	124,8	118,3	113,1	106,6	98,8	92,3	84,5	75,4	65,0	53,3	37,7	
1	150,8	145,0	139,2	131,9	126,1	118,9	110,2	102,9	94,2	84,1	72,5	59,4	42,0	
1/0	176,8	170,0	163,2	154,7	147,9	139,4	129,2	120,7	110,5	98,6	85,0	69,7	49,3	
2/0	202,8	195,0	187,2	177,4	169,6	159,9	148,2	138,4	126,7	113,1	97,5	79,9	56,5	
3/0	234,0	225,0	216,0	204,7	195,7	184,5	171,0	159,7	146,2	130,5	112,5	92,2	65,2	
4/0	270,4	260,0	249,6	236,6	226,2	213,2	197,6	184,6	169,0	150,8	130,0	106,6	75,4	
250 kcmil	301,6	290,0	278,4	263,9	252,3	237,8	220,4	205,9	188,5	168,2	145,0	118,9	84,1	
300	332,8	320,0	307,2	291,2	278,4	262,4	243,2	227,2	208,0	185,6	160,0	131,2	92,8	
350	364,0	350,0	336,0	318,5	304,5	287,0	266,0	248,5	227,5	203,0	175,0	143,5	101,5	
400	395,2	380,0	364,8	345,8	330,6	311,6	288,8	269,8	247,0	220,4	190,0	155,8	110,2	
500	447,2	430,0	412,8	391,3	374,1	352,6	326,8	305,3	279,5	249,4	215,0	176,3	124,7	
600	494,0	475,0	456,0	432,2	413,2	389,5	361,0	337,2	308,7	275,5	237,5	194,7	137,7	
700	540,8	520,0	499,2	473,2	452,4	426,4	395,2	369,2	338,0	301,6	260,0	213,2	150,8	
750	556,4	535,0	513,6	486,8	465,4	438,7	406,6	379,8	347,7	310,3	267,5	219,3	155,1	
800	577,2	555,0	532,8	505,0	482,8	455,1	421,8	394,0	360,7	321,9	277,5	227,5	160,9	
900	608,4	585,0	561,6	532,3	508,9	479,7	444,6	415,3	380,2	339,3	292,5	239,8	169,6	
1000	639,6	615,0	590,4	559,6	535,0	504,3	467,4	436,6	399,7	356,7	307,5	252,1	178,3	
1250	691,6	665,0	638,4	605,1	578,5	545,3	505,4	472,1	432,2	385,7	332,5	272,6	192,8	
1500	733,2	705,0	676,8	641,5	613,3	578,1	535,8	500,5	458,2	408,9	352,5	289,0	204,4	
1750	764,4	735,0	705,6	668,8	639,4	602,7	558,6	521,8	477,7	426,3	367,5	301,3	213,1	
2000	780,0	750,0	720,0	682,5	652,5	615,0	570,0	532,5	487,5	435,0	375,0	307,5	217,5	

Tabella B.4g. Coefficienti di correzione delle portate in funzione del numero di conduttori alimentati secondo NFPA 70 (NEC) - Ed. 2008 - Table 310.15(B)(2)(a), Ed. 2011-2017 - Table 310.15(B)(3)(a) e Ed. 2020-2023 - Table 310.15(C)(1)

Table B.4g. Adjustment factors for more than three current-carrying conductors according to NFPA 70 (NEC) - Ed. 2008/2011 - Ed. 2008 - Table 310.15(B)(2)(a), Ed. 2011-2017 - Table 310.15(B)(3)(a) and Ed. 2020-2023 - Table 310.15(C)(1)

Numero di conduttori alimentati in cavo, in guaina o canalina chiusa (raceway) o su canalina aperta (cable tray) Number of current-carrying conductors in cable, in raceway or in cable tray	Coefficiente di correzione della portata massima Ampacities adjustment factors
4÷6	0,80
7÷9	0,70
10÷20	0,50
21÷30	0,45
31÷40	0,40
>40	0,35

B.5 Portate dei Flexible Cords and Cables secondo NFPA 70 (NEC) Ampacities of Flexible Cords and Cables according to NFPA 70 (NEC)

Le tabelle mostrano le portate dei conduttori pubblicate nella norma alla quale si deve fare sempre riferimento.

The tables show the ampacities of the conductors published in the standard to which reference must always be made.

Tabella B.5a. Portata dei Flexible Cords and Cables tipo S, SJ, SJT con temperatura dell'isolamento 60°C e 2 conduttori alimentati secondo NFPA 70 (NEC) - Ed. 2020-2023 - Table 400.5(A)(1)

Table B.5a. Ampacities of Flexible Cords and Cables type S, SJ, SJT with 60°C insulation temperature and 2 current-carrying conductors according to NFPA 70 (NEC) - Ed. 2020-2023 - Table 400.5(A)(1)

Sezione del conduttore Conductor's size [AWG/kcmil]	Portata massima per Flexible Cords and Cables tipo S, SJ, SJT con 2 conduttori alimentati [A], Temperatura dell'isolamento 60°C Allowable ampacities of Flexible Cords and Cables type S, SJ, SJT with 2 current-carrying conductors [A], Insulation temperature 60°C												
	Temperatura ambiente Ta Ambient temperature Ta												
	21÷25°C	26÷30°C	31÷35°C	36÷40°C	41÷45°C	46÷50°C	51÷55°C	56÷60°C	61÷65°C	66÷70°C	71÷75°C	76÷80°C	81÷85°C
20 AWG	2,1	2,0	1,8	1,6	1,4	1,1	0,8	-	-	-	-	-	-
18	10,8	10,0	9,1	8,2	7,1	5,8	4,1	-	-	-	-	-	-
17	12,9	12,0	10,9	9,8	8,5	6,9	4,9	-	-	-	-	-	-
16	14,0	13,0	11,8	10,6	9,2	7,5	5,3	-	-	-	-	-	-
15	17,2	16,0	14,5	13,1	11,3	9,2	6,5	-	-	-	-	-	-
14	19,4	18,0	16,3	14,7	12,7	10,4	7,3	-	-	-	-	-	-
13	22,6	21,0	19,1	17,2	14,9	12,1	8,6	-	-	-	-	-	-
12	27,0	25,0	22,7	20,5	17,7	14,5	10,2	-	-	-	-	-	-
11	29,1	27,0	24,5	22,1	19,1	15,6	11,0	-	-	-	-	-	-
10	32,4	30,0	27,3	24,6	21,3	17,4	12,3	-	-	-	-	-	-
9	36,7	34,0	30,9	27,8	24,1	19,7	13,9	-	-	-	-	-	-
8	43,2	40,0	36,4	32,8	28,4	23,2	16,4	-	-	-	-	-	-
7	50,7	47,0	42,7	38,5	33,3	27,2	19,2	-	-	-	-	-	-
6	59,4	55,0	50,0	45,1	39,0	31,9	22,5	-	-	-	-	-	-
5	66,9	62,0	56,4	50,8	44,0	35,9	25,4	-	-	-	-	-	-
4	75,6	70,0	63,7	57,4	49,7	40,6	28,7	-	-	-	-	-	-
3	88,5	82,0	74,6	67,2	58,2	47,5	33,6	-	-	-	-	-	-
2	102,6	95,0	86,4	77,9	67,4	55,1	38,9	-	-	-	-	-	-

Tabella B.5b. Portata dei Flexible Cords and Cables tipo S, SJ, SJT con temperatura dell'isolamento 60°C e 3 conduttori alimentati secondo NFPA 70 (NEC) - Ed. 2020-2023 - Table 400.5(A)(1)

Table B.5b. Ampacities of Flexible Cords and Cables type S, SJ, SJT with 60°C insulation temperature and 3 current-carrying conductors according to NFPA 70 (NEC) - Ed. 2020-2023 - Table 400.5(A)(1)

Sezione del conduttore Conductor's size [AWG/kcmil]	Portata massima per Flexible Cords and Cables tipo S, SJ, SJT con 3 conduttori alimentati [A], Temperatura dell'isolamento 60°C Allowable ampacities of Flexible Cords and Cables type S, SJ, SJT with 3 current-carrying conductors [A], Insulation temperature 60°C												
	Temperatura ambiente Ta Ambient temperature Ta												
	21÷25°C	26÷30°C	31÷35°C	36÷40°C	41÷45°C	46÷50°C	51÷55°C	56÷60°C	61÷65°C	66÷70°C	71÷75°C	76÷80°C	81÷85°C
20 AWG	-	-	-	-	-	-	-	-	-	-	-	-	-
18	7,5	7,0	6,3	5,7	4,9	4,0	2,8	-	-	-	-	-	-
17	9,7	9,0	8,1	7,3	6,3	5,2	3,6	-	-	-	-	-	-
16	10,8	10,0	9,1	8,2	7,1	5,8	4,1	-	-	-	-	-	-
15	12,9	12,0	10,9	9,8	8,5	6,9	4,9	-	-	-	-	-	-
14	16,2	15,0	13,6	12,3	10,6	8,7	6,1	-	-	-	-	-	-
13	18,3	17,0	15,4	13,9	12,0	9,8	6,9	-	-	-	-	-	-
12	21,6	20,0	18,2	16,4	14,2	11,6	8,2	-	-	-	-	-	-
11	24,8	23,0	20,9	18,8	16,3	13,3	9,4	-	-	-	-	-	-
10	27,0	25,0	22,7	20,5	17,7	14,5	10,2	-	-	-	-	-	-
9	31,3	29,0	26,3	23,7	20,5	16,8	11,8	-	-	-	-	-	-
8	37,8	35,0	31,8	28,7	24,8	20,3	14,3	-	-	-	-	-	-
7	43,2	40,0	36,4	32,8	28,4	23,2	16,4	-	-	-	-	-	-
6	48,6	45,0	40,9	36,9	31,9	26,1	18,4	-	-	-	-	-	-
5	56,1	52,0	47,3	42,6	36,9	30,1	21,3	-	-	-	-	-	-
4	64,8	60,0	54,6	49,2	42,6	34,8	24,6	-	-	-	-	-	-
3	75,6	70,0	63,7	57,4	49,7	40,6	28,7	-	-	-	-	-	-
2	86,4	80,0	72,8	65,6	56,8	46,4	32,8	-	-	-	-	-	-

Tabella B.5c. Portata dei Flexible Cords and Cables tipo S, SJ, SJT con temperatura dell'isolamento 60°C e 4÷6 conduttori alimentati secondo NFPA 70 (NEC) - Ed. 2020-2023 - Table 400.5(A)(1)
 Table B.5c. Ampacities of Flexible Cords and Cables type S, SJ, SJT with 60°C insulation temperature and 4÷6 current-carrying conductors according to NFPA 70 (NEC) - Ed. 2020-2023 - Table 400.5(A)(1)

Sezione del conduttore Conductor's size [AWG/kcmil]	Portata massima per Flexible Cords and Cables tipo S, SJ, SJT con 4÷6 conduttori alimentati [A] , Temperatura dell'isolamento 60°C <i>Allowable ampacities of Flexible Cords and Cables type S, SJ, SJT with 4÷6 current-carrying conductors [A], Insulation temperature 60°C</i>												
	Temperatura ambiente Ta <i>Ambient temperature Ta</i>												
	21÷25°C	26÷30°C	31÷35°C	36÷40°C	41÷45°C	46÷50°C	51÷55°C	56÷60°C	61÷65°C	66÷70°C	71÷75°C	76÷80°C	81÷85°C
20 AWG	-	-	-	-	-	-	-	-	-	-	-	-	-
18	6,0	5,6	5,0	4,5	3,9	3,2	2,2	-	-	-	-	-	-
17	7,7	7,2	6,5	5,9	5,1	4,1	2,9	-	-	-	-	-	-
16	8,6	8,0	7,2	6,5	5,6	4,6	3,2	-	-	-	-	-	-
15	10,3	9,6	8,7	7,8	6,8	5,5	3,9	-	-	-	-	-	-
14	12,9	12,0	10,9	9,8	8,5	6,9	4,9	-	-	-	-	-	-
13	14,6	13,6	12,3	11,1	9,6	7,8	5,5	-	-	-	-	-	-
12	17,2	16,0	14,5	13,1	11,3	9,2	6,5	-	-	-	-	-	-
11	19,8	18,4	16,7	15,0	13,0	10,6	7,5	-	-	-	-	-	-
10	21,6	20,0	18,2	16,4	14,2	11,6	8,2	-	-	-	-	-	-
9	25,0	23,2	21,1	19,0	16,4	13,4	9,5	-	-	-	-	-	-
8	30,2	28,0	25,4	22,9	19,8	16,2	11,4	-	-	-	-	-	-
7	34,5	32,0	29,1	26,2	22,7	18,5	13,1	-	-	-	-	-	-
6	38,8	36,0	32,7	29,5	25,5	20,8	14,7	-	-	-	-	-	-
5	44,9	41,6	37,8	34,1	29,5	24,1	17,0	-	-	-	-	-	-
4	51,8	48,0	43,6	39,3	34,0	27,8	19,6	-	-	-	-	-	-
3	60,4	56,0	50,9	45,9	39,7	32,4	22,9	-	-	-	-	-	-
2	69,1	64,0	58,2	52,4	45,4	37,1	26,2	-	-	-	-	-	-

Tabella B.5d. Portata dei Flexible Cords and Cables tipo SOOW, SJOOW, STOW, SJTOW con temperatura dell'isolamento 90°C e 2 conduttori alimentati secondo NFPA 70 (NEC) - Ed. 2020-2023 - Table 400.5(A)(1)
 Table B.5d. Ampacities of Flexible Cords and Cables type SOOW, SJOOW, STOW, SJTOW with 90°C insulation temperature and 2 current-carrying conductors according to NFPA 70 (NEC) - Ed. 2020-2023 - Table 400.5(A)(1)

Sezione del conduttore Conductor's size [AWG/kcmil]	Portata massima per Flexible Cords and Cables tipo SOOW, SJOOW, STOW, SJTOW con 2 conduttori alimentati [A] , Temperatura dell'isolamento 90°C <i>Allowable ampacities of Flexible Cords and Cables type SOOW, SJOOW, STOW, SJTOW with 2 current-carrying conductors [A], Insulation temperature 90°C</i>												
	Temperatura ambiente Ta <i>Ambient temperature Ta</i>												
	21÷25°C	26÷30°C	31÷35°C	36÷40°C	41÷45°C	46÷50°C	51÷55°C	56÷60°C	61÷65°C	66÷70°C	71÷75°C	76÷80°C	81÷85°C
20 AWG	2,0	2,0	1,9	1,8	1,7	1,6	1,5	1,4	1,3	1,1	1,0	0,8	0,5
18	10,4	10,0	9,6	9,1	8,7	8,2	7,6	7,1	6,5	5,8	5,0	4,1	2,9
17	12,4	12,0	11,5	10,9	10,4	9,8	9,1	8,5	7,8	6,9	6,0	4,9	3,4
16	13,5	13,0	12,4	11,8	11,3	10,6	9,8	9,2	8,4	7,5	6,5	5,3	3,7
15	16,6	16,0	15,3	14,5	13,9	13,1	12,1	11,3	10,4	9,2	8,0	6,5	4,6
14	18,7	18,0	17,2	16,3	15,6	14,7	13,6	12,7	11,7	10,4	9,0	7,3	5,2
13	21,8	21,0	20,1	19,1	18,2	17,2	15,9	14,9	13,6	12,1	10,5	8,6	6,0
12	26,0	25,0	24,0	22,7	21,7	20,5	19,0	17,7	16,2	14,5	12,5	10,2	7,2
11	28,0	27,0	25,9	24,5	23,4	22,1	20,5	19,1	17,5	15,6	13,5	11,0	7,8
10	31,2	30,0	28,8	27,3	26,1	24,6	22,8	21,3	19,5	17,4	15,0	12,3	8,7
9	35,3	34,0	32,6	30,9	29,5	27,8	25,8	24,1	22,1	19,7	17,0	13,9	9,8
8	41,6	40,0	38,4	36,4	34,8	32,8	30,4	28,4	26,0	23,2	20,0	16,4	11,6
7	48,8	47,0	45,1	42,7	40,8	38,5	35,7	33,3	30,5	27,2	23,5	19,2	13,6
6	57,2	55,0	52,8	50,0	47,8	45,1	41,8	39,0	35,7	31,9	27,5	22,5	15,9
5	64,4	62,0	59,5	56,4	53,9	50,8	47,1	44,0	40,3	35,9	31,0	25,4	17,9
4	72,8	70,0	67,2	63,7	60,9	57,4	53,2	49,7	45,5	40,6	35,0	28,7	20,3
3	85,2	82,0	78,7	74,6	71,3	67,2	62,3	58,2	53,3	47,5	41,0	33,6	23,7
2	98,8	95,0	91,2	86,4	82,6	77,9	72,2	67,4	61,7	55,1	47,5	38,9	27,5

Tabella B.5e. Portata dei Flexible Cords and Cables tipo SOOW, SJOOW, STOW, SJTOW con temperatura dell'isolamento 90°C e 3 conduttori alimentati secondo NFPA 70 (NEC) - Ed. 2020-2023 - Table 400.5(A)(1)

Table B.5e. Ampacities of Flexible Cords and Cables type SOOW, SJOOW, STOW, SJTOW with 90°C insulation temperature and 3 current-carrying conductors according to NFPA 70 (NEC) - Ed. 2020-2023 Table 400.5(A)(1)

Sezione del conduttore Conductor's size [AWG/kcmil]	Portata massima per Flexible Cords and Cables tipo SOOW, SJOOW, STOW, SJTOW con 3 conduttori alimentati [A], Temperatura dell'isolamento 90°C Allowable ampacities of Flexible Cords and Cables type SOOW, SJOOW, STOW, SJTOW with 3 current-carrying conductors [A], Insulation temperature 90°C												
	Temperatura ambiente Ta Ambient temperature Ta												
	21÷25°C	26÷30°C	31÷35°C	36÷40°C	41÷45°C	46÷50°C	51÷55°C	56÷60°C	61÷65°C	66÷70°C	71÷75°C	76÷80°C	81÷85°C
20 AWG	-	-	-	-	-	-	-	-	-	-	-	-	-
18	7,2	7,0	6,7	6,3	6,0	5,7	5,3	4,9	4,5	4,0	3,5	2,8	2,0
17	9,3	9,0	8,6	8,1	7,8	7,3	6,8	6,3	5,8	5,2	4,5	3,6	2,6
16	10,4	10,0	9,6	9,1	8,7	8,2	7,6	7,1	6,5	5,8	5,0	4,1	2,9
15	12,4	12,0	11,5	10,9	10,4	9,8	9,1	8,5	7,8	6,9	6,0	4,9	3,4
14	15,6	15,0	14,4	13,6	13,0	12,3	11,4	10,6	9,7	8,7	7,5	6,1	4,3
13	17,6	17,0	16,3	15,4	14,7	13,9	12,9	12,0	11,0	9,8	8,5	6,9	4,9
12	20,8	20,0	19,2	18,2	17,4	16,4	15,2	14,2	13,0	11,6	10,0	8,2	5,8
11	23,9	23,0	22,0	20,9	20,0	18,8	17,4	16,3	14,9	13,3	11,5	9,4	6,6
10	26,0	25,0	24,0	22,7	21,7	20,5	19,0	17,7	16,2	14,5	12,5	10,2	7,2
9	30,1	29,0	27,8	26,3	25,2	23,7	22,0	20,5	18,8	16,8	14,5	11,8	8,4
8	36,4	35,0	33,6	31,8	30,4	28,7	26,6	24,8	22,7	20,3	17,5	14,3	10,1
7	41,6	40,0	38,4	36,4	34,8	32,8	30,4	28,4	26,0	23,2	20,0	16,4	11,6
6	46,8	45,0	43,2	40,9	39,1	36,9	34,2	31,9	29,2	26,1	22,5	18,4	13,0
5	54,0	52,0	49,9	47,3	45,2	42,6	39,5	36,9	33,8	30,1	26,0	21,3	15,0
4	62,4	60,0	57,6	54,6	52,2	49,2	45,6	42,6	39,0	34,8	30,0	24,6	17,4
3	72,8	70,0	67,2	63,7	60,9	57,4	53,2	49,7	45,5	40,6	35,0	28,7	20,3
2	83,2	80,0	76,8	72,8	69,6	65,6	60,8	56,8	52,0	46,4	40,0	32,8	23,2

Tabella B.5f. Portata dei Flexible Cords and Cables tipo SOOW, SJOOW, STOW, SJTOW con temperatura dell'isolamento 90°C e 4÷6 conduttori alimentati secondo NFPA 70 (NEC) - Ed. 2020-2023 - Table 400.5(A)(1)

Table B.5f. Ampacities of Flexible Cords and Cables type SOOW, SJOOW, STOW, SJTOW with 90°C insulation temperature and 4÷6 current-carrying conductors according to NFPA 70 (NEC) - Ed. 2020-2023 Table 400.5(A)(1)

Sezione del conduttore Conductor's size [AWG/kcmil]	Portata massima per Flexible Cords and Cables tipo SOOW, SJOOW, STOW, SJTOW con 4÷6 conduttori alimentati [A], Temperatura dell'isolamento 90°C Allowable ampacities of Flexible Cords and Cables type SOOW, SJOOW, STOW, SJTOW with 4÷6 current-carrying conductors [A], Insulation temperature 90°C												
	Temperatura ambiente Ta Ambient temperature Ta												
	21÷25°C	26÷30°C	31÷35°C	36÷40°C	41÷45°C	46÷50°C	51÷55°C	56÷60°C	61÷65°C	66÷70°C	71÷75°C	76÷80°C	81÷85°C
20 AWG	-	-	-	-	-	-	-	-	-	-	-	-	-
18	5,8	5,6	5,3	5,0	4,8	4,5	4,2	3,9	3,6	3,2	2,8	2,2	1,6
17	7,4	7,2	6,9	6,5	6,2	5,9	5,4	5,1	4,6	4,1	3,6	2,9	2,0
16	8,3	8,0	7,6	7,2	6,9	6,5	6,0	5,6	5,2	4,6	4,0	3,2	2,3
15	9,9	9,6	9,2	8,7	8,3	7,8	7,2	6,8	6,2	5,5	4,8	3,9	2,7
14	12,4	12,0	11,5	10,9	10,4	9,8	9,1	8,5	7,8	6,9	6,0	4,9	3,4
13	14,1	13,6	13,0	12,3	11,8	11,1	10,3	9,6	8,8	7,8	6,8	5,5	3,9
12	16,6	16,0	15,3	14,5	13,9	13,1	12,1	11,3	10,4	9,2	8,0	6,5	4,6
11	19,1	18,4	17,6	16,7	16,0	15,0	13,9	13,0	11,9	10,6	9,2	7,5	5,3
10	20,8	20,0	19,2	18,2	17,4	16,4	15,2	14,2	13,0	11,6	10,0	8,2	5,8
9	24,1	23,2	22,2	21,1	20,1	19,0	17,6	16,4	15,0	13,4	11,6	9,5	6,7
8	29,1	28,0	26,8	25,4	24,3	22,9	21,2	19,8	18,2	16,2	14,0	11,4	8,1
7	33,2	32,0	30,7	29,1	27,8	26,2	24,3	22,7	20,8	18,5	16,0	13,1	9,2
6	37,4	36,0	34,5	32,7	31,3	29,5	27,3	25,5	23,4	20,8	18,0	14,7	10,4
5	43,2	41,6	39,9	37,8	36,1	34,1	31,6	29,5	27,0	24,1	20,8	17,0	12,0
4	49,9	48,0	46,0	43,6	41,7	39,3	36,4	34,0	31,2	27,8	24,0	19,6	13,9
3	58,2	56,0	53,7	50,9	48,7	45,9	42,5	39,7	36,4	32,4	28,0	22,9	16,2
2	66,5	64,0	61,4	58,2	55,6	52,4	48,6	45,4	41,6	37,1	32,0	26,2	18,5

Tabella B.5g. Portata dei Flexible Cords and Cables tipo SOOW, STOW con temperatura dell'isolamento 90°C e 7÷9 conduttori alimentati secondo NFPA 70 (NEC) - Ed. 2020-2023 - Table 400.5(A)(1)
 Table B.5g. Ampacities of Flexible Cords and Cables type SOOW, STOW with 90°C insulation temperature and 7÷9 current-carrying conductors according to NFPA 70 (NEC) - Ed. 2020-2023 - Table 400.5(A)(1)

Sezione del conduttore Conductor's size [AWG/kcmil]	Portata massima per Flexible Cords and Cables tipo SOOW, STOW con 7÷9 conduttori alimentati [A], Temperatura dell'isolamento 90°C Allowable ampacities of Flexible Cords and Cables type SOOW, STOW with 7÷9 current-carrying conductors [A], Insulation temperature 90°C												
	Temperatura ambiente Ta Ambient temperature Ta												
	21÷25°C	26÷30°C	31÷35°C	36÷40°C	41÷45°C	46÷50°C	51÷55°C	56÷60°C	61÷65°C	66÷70°C	71÷75°C	76÷80°C	81÷85°C
20 AWG	-	-	-	-	-	-	-	-	-	-	-	-	-
18	5,0	4,9	4,7	4,4	4,2	4,0	3,7	3,4	3,1	2,8	2,4	2,0	1,4
17	6,5	6,3	6,0	5,7	5,4	5,1	4,7	4,4	4,0	3,6	3,1	2,5	1,8
16	7,2	7,0	6,7	6,3	6,0	5,7	5,3	4,9	4,5	4,0	3,5	2,8	2,0
15	8,7	8,4	8,0	7,6	7,3	6,8	6,3	5,9	5,4	4,8	4,2	3,4	2,4
14	10,9	10,5	10,0	9,5	9,1	8,6	7,9	7,4	6,8	6,0	5,2	4,3	3,0
13	12,3	11,9	11,4	10,8	10,3	9,7	9,0	8,4	7,7	6,9	5,9	4,8	3,4
12	14,5	14,0	13,4	12,7	12,1	11,4	10,6	9,9	9,1	8,1	7,0	5,7	4,0
11	16,7	16,1	15,4	14,6	14,0	13,2	12,2	11,4	10,4	9,3	8,0	6,6	4,6
10	18,2	17,5	16,8	15,9	15,2	14,3	13,3	12,4	11,3	10,1	8,7	7,1	5,0
9	21,1	20,3	19,4	18,4	17,6	16,6	15,4	14,4	13,1	11,7	10,1	8,3	5,8
8	25,4	24,5	23,5	22,2	21,3	20,0	18,6	17,3	15,9	14,2	12,2	10,0	7,1
7	29,1	28,0	26,8	25,4	24,3	22,9	21,2	19,8	18,2	16,2	14,0	11,4	8,1
6	32,7	31,5	30,2	28,6	27,4	25,8	23,9	22,3	20,4	18,2	15,7	12,9	9,1
5	37,8	36,4	34,9	33,1	31,6	29,8	27,6	25,8	23,6	21,1	18,2	14,9	10,5
4	43,6	42,0	40,3	38,2	36,5	34,4	31,9	29,8	27,3	24,3	21,0	17,2	12,1
3	50,9	49,0	47,0	44,5	42,6	40,1	37,2	34,7	31,8	28,4	24,5	20,0	14,2
2	58,2	56,0	53,7	50,9	48,7	45,9	42,5	39,7	36,4	32,4	28,0	22,9	16,2

Tabella B.5h. Portata dei Flexible Cords and Cables tipo SOOW, STOW con temperatura dell'isolamento 90°C e 10÷20 conduttori alimentati secondo NFPA 70 (NEC) - Ed. 2020-2023 - Table 400.5(A)(1)
 Table B.5h. Ampacities of Flexible Cords and Cables type SOOW, STOW with 90°C insulation temperature and 10÷20 current-carrying conductors according to NFPA 70 (NEC) - Ed. 2020-2023 - Table 400.5(A)(1)

Sezione del conduttore Conductor's size [AWG/kcmil]	Portata massima per Flexible Cords and Cables tipo SOOW, STOW con 10÷20 conduttori alimentati [A], Temperatura dell'isolamento 90°C Allowable ampacities of Flexible Cords and Cables type SOOW, STOW with 10÷20 current-carrying conductors [A], Insulation temperature 90°C												
	Temperatura ambiente Ta Ambient temperature Ta												
	21÷25°C	26÷30°C	31÷35°C	36÷40°C	41÷45°C	46÷50°C	51÷55°C	56÷60°C	61÷65°C	66÷70°C	71÷75°C	76÷80°C	81÷85°C
20 AWG	-	-	-	-	-	-	-	-	-	-	-	-	-
18	3,6	3,5	3,3	3,1	3,0	2,8	2,6	2,4	2,2	2,0	1,7	1,4	1,0
17	4,6	4,5	4,3	4,0	3,9	3,6	3,4	3,1	2,9	2,6	2,2	1,8	1,3
16	5,2	5,0	4,8	4,5	4,3	4,1	3,8	3,5	3,2	2,9	2,5	2,0	1,4
15	6,2	6,0	5,7	5,4	5,2	4,9	4,5	4,2	3,9	3,4	3,0	2,4	1,7
14	7,8	7,5	7,2	6,8	6,5	6,1	5,7	5,3	4,8	4,3	3,7	3,0	2,1
13	8,8	8,5	8,1	7,7	7,3	6,9	6,4	6,0	5,5	4,9	4,2	3,4	2,4
12	10,4	10,0	9,6	9,1	8,7	8,2	7,6	7,1	6,5	5,8	5,0	4,1	2,9
11	11,9	11,5	11,0	10,4	10,0	9,4	8,7	8,1	7,4	6,6	5,7	4,7	3,3
10	13,0	12,5	12,0	11,3	10,8	10,2	9,5	8,8	8,1	7,2	6,2	5,1	3,6
9	15,0	14,5	13,9	13,1	12,6	11,8	11,0	10,2	9,4	8,4	7,2	5,9	4,2
8	18,2	17,5	16,8	15,9	15,2	14,3	13,3	12,4	11,3	10,1	8,7	7,1	5,0
7	20,8	20,0	19,2	18,2	17,4	16,4	15,2	14,2	13,0	11,6	10,0	8,2	5,8
6	23,4	22,5	21,6	20,4	19,5	18,4	17,1	15,9	14,6	13,0	11,2	9,2	6,5
5	27,0	26,0	24,9	23,6	22,6	21,3	19,7	18,4	16,9	15,0	13,0	10,6	7,5
4	31,2	30,0	28,8	27,3	26,1	24,6	22,8	21,3	19,5	17,4	15,0	12,3	8,7
3	36,4	35,0	33,6	31,8	30,4	28,7	26,6	24,8	22,7	20,3	17,5	14,3	10,1
2	41,6	40,0	38,4	36,4	34,8	32,8	30,4	28,4	26,0	23,2	20,0	16,4	11,6

Tabella B.5i. Portata dei Flexible Cords and Cables tipo SOOW, STOW con temperatura dell'isolamento 90°C e 21÷30 conduttori alimentati secondo NFPA 70 (NEC) - Ed. 2020-2023 - Table 400.5(A)(1)
 Table B.5i. Ampacities of Flexible Cords and Cables type SOOW, STOW with 90°C insulation temperature and 21÷30 current-carrying conductors according to NFPA 70 (NEC) - Ed. 2020-2023 - Table 400.5(A)(1)

Sezione del conduttore Conductor's size [AWG/kcmil]	Portata massima per Flexible Cords and Cables tipo SOOW, STOW con 21÷30 conduttori alimentati [A], Temperatura dell'isolamento 90°C Allowable ampacities of Flexible Cords and Cables type SOOW, STOW with 21÷30 current-carrying conductors [A], Insulation temperature 90°C												
	Temperatura ambiente Ta Ambient temperature Ta												
	21÷25°C	26÷30°C	31÷35°C	36÷40°C	41÷45°C	46÷50°C	51÷55°C	56÷60°C	61÷65°C	66÷70°C	71÷75°C	76÷80°C	81÷85°C
20 AWG	-	-	-	-	-	-	-	-	-	-	-	-	-
18	3,2	3,2	3,0	2,8	2,7	2,5	2,3	2,2	2,0	1,8	1,5	1,2	0,9
17	4,2	4,1	3,8	3,6	3,5	3,3	3,0	2,8	2,6	2,3	2,0	1,6	1,1
16	4,6	4,5	4,3	4,0	3,9	3,6	3,4	3,1	2,9	2,6	2,2	1,8	1,3
15	5,6	5,4	5,1	4,9	4,6	4,4	4,1	3,8	3,5	3,1	2,7	2,2	1,5
14	7,0	6,8	6,4	6,1	5,8	5,5	5,1	4,7	4,3	3,9	3,3	2,7	1,9
13	7,9	7,7	7,3	6,9	6,6	6,2	5,8	5,4	4,9	4,4	3,8	3,1	2,2
12	9,3	9,0	8,6	8,1	7,8	7,3	6,8	6,3	5,8	5,2	4,5	3,6	2,6
11	10,7	10,4	9,9	9,4	9,0	8,4	7,8	7,3	6,7	6,0	5,1	4,2	3,0
10	11,7	11,3	10,8	10,2	9,7	9,2	8,5	7,9	7,3	6,5	5,6	4,6	3,2
9	13,5	13,1	12,5	11,8	11,3	10,7	9,9	9,2	8,4	7,5	6,5	5,3	3,7
8	16,3	15,8	15,1	14,3	13,7	12,9	11,9	11,1	10,2	9,1	7,8	6,4	4,5
7	18,7	18,0	17,2	16,3	15,6	14,7	13,6	12,7	11,7	10,4	9,0	7,3	5,2
6	21,0	20,3	19,4	18,4	17,6	16,6	15,3	14,3	13,1	11,7	10,1	8,3	5,8
5	24,3	23,4	22,4	21,2	20,3	19,1	17,7	16,6	15,2	13,5	11,7	9,5	6,7
4	28,0	27,0	25,9	24,5	23,4	22,1	20,5	19,1	17,5	15,6	13,5	11,0	7,8
3	32,7	31,5	30,2	28,6	27,4	25,8	23,9	22,3	20,4	18,2	15,7	12,9	9,1
2	37,4	36,0	34,5	32,7	31,3	29,5	27,3	25,5	23,4	20,8	18,0	14,7	10,4

Tabella B.5i. Portata dei Flexible Cords and Cables tipo SOOW, STOW con temperatura dell'isolamento 90°C e 31÷40 conduttori alimentati secondo NFPA 70 (NEC) - Ed. 2020-2023 - Table 400.5(A)(1)
 Table B.5i. Ampacities of Flexible Cords and Cables type SOOW, STOW with 90°C insulation temperature and 31÷40 current-carrying conductors according to NFPA 70 (NEC) - Ed. 2020-2023 - Table 400.5(A)(1)

Sezione del conduttore Conductor's size [AWG/kcmil]	Portata massima per Flexible Cords and Cables tipo SOOW, STOW con 31÷40 conduttori alimentati [A], Temperatura dell'isolamento 90°C Allowable ampacities of Flexible Cords and Cables type SOOW, STOW with 31÷40 current-carrying conductors [A], Insulation temperature 90°C												
	Temperatura ambiente Ta Ambient temperature Ta												
	21÷25°C	26÷30°C	31÷35°C	36÷40°C	41÷45°C	46÷50°C	51÷55°C	56÷60°C	61÷65°C	66÷70°C	71÷75°C	76÷80°C	81÷85°C
20 AWG	-	-	-	-	-	-	-	-	-	-	-	-	-
18	2,9	2,8	2,6	2,5	2,4	2,2	2,1	1,9	1,8	1,6	1,4	1,1	0,8
17	3,7	3,6	3,4	3,2	3,1	2,9	2,7	2,5	2,3	2,0	1,8	1,4	1,0
16	4,1	4,0	3,8	3,6	3,4	3,2	3,0	2,8	2,6	2,3	2,0	1,6	1,1
15	4,9	4,8	4,6	4,3	4,1	3,9	3,6	3,4	3,1	2,7	2,4	1,9	1,3
14	6,2	6,0	5,7	5,4	5,2	4,9	4,5	4,2	3,9	3,4	3,0	2,4	1,7
13	7,0	6,8	6,5	6,1	5,9	5,5	5,1	4,8	4,4	3,9	3,4	2,7	1,9
12	8,3	8,0	7,6	7,2	6,9	6,5	6,0	5,6	5,2	4,6	4,0	3,2	2,3
11	9,5	9,2	8,8	8,3	8,0	7,5	6,9	6,5	5,9	5,3	4,6	3,7	2,6
10	10,4	10,0	9,6	9,1	8,7	8,2	7,6	7,1	6,5	5,8	5,0	4,1	2,9
9	12,0	11,6	11,1	10,5	10,0	9,5	8,8	8,2	7,5	6,7	5,8	4,7	3,3
8	14,5	14,0	13,4	12,7	12,1	11,4	10,6	9,9	9,1	8,1	7,0	5,7	4,0
7	16,6	16,0	15,3	14,5	13,9	13,1	12,1	11,3	10,4	9,2	8,0	6,5	4,6
6	18,7	18,0	17,2	16,3	15,6	14,7	13,6	12,7	11,7	10,4	9,0	7,3	5,2
5	21,6	20,8	19,9	18,9	18,0	17,0	15,8	14,7	13,5	12,0	10,4	8,5	6,0
4	24,9	24,0	23,0	21,8	20,8	19,6	18,2	17,0	15,6	13,9	12,0	9,8	6,9
3	29,1	28,0	26,8	25,4	24,3	22,9	21,2	19,8	18,2	16,2	14,0	11,4	8,1
2	33,2	32,0	30,7	29,1	27,8	26,2	24,3	22,7	20,8	18,5	16,0	13,1	9,2

Tabella B.5m. Portata dei Flexible Cords and Cables tipo SOOW, STOW con temperatura dell'isolamento 90°C e 41÷60 conduttori alimentati secondo NFPA 70 (NEC) - Ed. 2020-2023 - Table 400.5(A)(1)
 Table B.5m. Ampacities of Flexible Cords and Cables type SOOW, STOW with 90°C insulation temperature and 41÷60 current-carrying conductors according to NFPA 70 (NEC) - Ed. 2020-2023 - Table 400.5(A)(1)

Sezione del conduttore Conductor's size [AWG/kcmil]	Portata massima per Flexible Cords and Cables tipo SOOW, STOW con 41÷60 conduttori alimentati [A], Temperatura dell'isolamento 90°C Allowable ampacities of Flexible Cords and Cables type SOOW, STOW with 41÷60 current-carrying conductors [A], Insulation temperature 90°C												
	Temperatura ambiente Ta Ambient temperature Ta												
	21÷25°C	26÷30°C	31÷35°C	36÷40°C	41÷45°C	46÷50°C	51÷55°C	56÷60°C	61÷65°C	66÷70°C	71÷75°C	76÷80°C	81÷85°C
20 AWG	-	-	-	-	-	-	-	-	-	-	-	-	-
18	2,5	2,5	2,3	2,2	2,1	2,0	1,8	1,7	1,5	1,4	1,2	1,0	0,7
17	3,2	3,2	3,0	2,8	2,7	2,5	2,3	2,2	2,0	1,8	1,5	1,2	0,9
16	3,6	3,5	3,3	3,1	3,0	2,8	2,6	2,4	2,2	2,0	1,7	1,4	1,0
15	4,3	4,2	4,0	3,8	3,6	3,4	3,1	2,9	2,7	2,4	2,1	1,7	1,2
14	5,4	5,3	5,0	4,7	4,5	4,3	3,9	3,7	3,4	3,0	2,6	2,1	1,5
13	6,1	6,0	5,7	5,4	5,1	4,8	4,5	4,2	3,8	3,4	2,9	2,4	1,7
12	7,2	7,0	6,7	6,3	6,0	5,7	5,3	4,9	4,5	4,0	3,5	2,8	2,0
11	8,3	8,1	7,7	7,3	7,0	6,6	6,1	5,7	5,2	4,6	4,0	3,3	2,3
10	9,1	8,8	8,4	7,9	7,6	7,1	6,6	6,2	5,6	5,0	4,3	3,5	2,5
9	10,5	10,2	9,7	9,2	8,8	8,3	7,7	7,2	6,5	5,8	5,0	4,1	2,9
8	12,7	12,3	11,7	11,1	10,6	10,0	9,3	8,6	7,9	7,1	6,1	5,0	3,5
7	14,5	14,0	13,4	12,7	12,1	11,4	10,6	9,9	9,1	8,1	7,0	5,7	4,0
6	16,3	15,8	15,1	14,3	13,7	12,9	11,9	11,1	10,2	9,1	7,8	6,4	4,5
5	18,9	18,2	17,4	16,5	15,8	14,9	13,8	12,9	11,8	10,5	9,1	7,4	5,2
4	21,8	21,0	20,1	19,1	18,2	17,2	15,9	14,9	13,6	12,1	10,5	8,6	6,0
3	25,4	24,5	23,5	22,2	21,3	20,0	18,6	17,3	15,9	14,2	12,2	10,0	7,1
2	29,1	28,0	26,8	25,4	24,3	22,9	21,2	19,8	18,2	16,2	14,0	11,4	8,1

Tabella B.5n. Portata dei Flexible Cords and Cables tipo W, G, G-GC con temperatura dell'isolamento 90°C e 1 conduttore alimentato secondo NFPA 70 (NEC) - Ed. 2020-2023 - Table 400.5(A)(2)
 Table B.5n. Ampacities of Flexible Cords and Cables type W, G, G-GC with 90°C insulation temperature and 1 current-carrying conductor according to NFPA 70 (NEC) - Ed. 2020-2023 - Table 400.5(A)(2)

Sezione del conduttore Conductor's size [AWG/kcmil]	Portata massima per Flexible Cords and Cables tipo W, G, G-GC con 1 conduttore alimentato [A], Temperatura dell'isolamento 90°C Allowable ampacities of Flexible Cords and Cables type W, G, G-GC with 1 current-carrying conductor [A], Insulation temperature 90°C												
	Temperatura ambiente Ta Ambient temperature Ta												
	21÷25°C	26÷30°C	31÷35°C	36÷40°C	41÷45°C	46÷50°C	51÷55°C	56÷60°C	61÷65°C	66÷70°C	71÷75°C	76÷80°C	81÷85°C
12 AWG	-	-	-	-	-	-	-	-	-	-	-	-	-
10	-	-	-	-	-	-	-	-	-	-	-	-	-
8	83,2	80,0	76,8	72,8	69,6	65,6	60,8	56,8	52,0	46,4	40,0	32,8	23,2
6	109,2	105,0	100,8	95,5	91,3	86,1	79,8	74,5	68,2	60,9	52,5	43,0	30,4
4	145,6	140,0	134,4	127,4	121,8	114,8	106,4	99,4	91,0	81,2	70,0	57,4	40,6
3	171,6	165,0	158,4	150,1	143,5	135,3	125,4	117,1	107,2	95,7	82,5	67,6	47,8
2	197,6	190,0	182,4	172,9	165,3	155,8	144,4	134,9	123,5	110,2	95,0	77,9	55,1
1	228,8	220,0	211,2	200,2	191,4	180,4	167,2	156,2	143,0	127,6	110,0	90,2	63,8
1/0	270,4	260,0	249,6	236,6	226,2	213,2	197,6	184,6	169,0	150,8	130,0	106,6	75,4
2/0	312,0	300,0	288,0	273,0	261,0	246,0	228,0	213,0	195,0	174,0	150,0	123,0	87,0
3/0	364,0	350,0	336,0	318,5	304,5	287,0	266,0	248,5	227,5	203,0	175,0	143,5	101,5
4/0	421,2	405,0	388,8	368,5	352,3	332,1	307,8	287,5	263,2	234,9	202,5	166,0	117,4
250	473,2	455,0	436,8	414,0	395,8	373,1	345,8	323,0	295,7	263,9	227,5	186,5	131,9
300	525,2	505,0	484,8	459,5	439,3	414,1	383,8	358,5	328,2	292,9	252,5	207,0	146,4
350	592,8	570,0	547,2	518,7	495,9	467,4	433,2	404,7	370,5	330,6	285,0	233,7	165,3
400	639,6	615,0	590,4	559,6	535,0	504,3	467,4	436,6	399,7	356,7	307,5	252,1	178,3
500	728,0	700,0	672,0	637,0	609,0	574,0	532,0	497,0	455,0	406,0	350,0	287,0	203,0
600	811,2	780,0	748,8	709,8	678,6	639,6	592,8	553,8	507,0	452,4	390,0	319,8	226,2
700	889,2	855,0	820,8	778,0	743,8	701,1	649,8	607,0	555,7	495,9	427,5	350,5	247,9
750	920,4	885,0	849,6	805,3	769,9	725,7	672,6	628,3	575,2	513,3	442,5	362,8	256,6
800	956,8	920,0	883,2	837,2	800,4	754,4	699,2	653,2	598,0	533,6	460,0	377,2	266,8
900	1024,4	985,0	945,6	896,3	856,9	807,7	748,6	699,3	640,2	571,3	492,5	403,8	285,6
1000	1097,2	1055,0	1012,8	960,0	917,8	865,1	801,8	749,0	685,7	611,9	527,5	432,5	305,9

Tabella B.5o. Portata dei Flexible Cords and Cables tipo W, G, G-GC con temperatura dell'isolamento 90°C e 2 conduttori alimentati secondo NFPA 70 (NEC) - Ed. 2020-2023 - Table 400.5(A)(2)
 Table B.5o. Ampacities of Flexible Cords and Cables type W, G, G-GC with 90°C insulation temperature and 2 current-carrying conductors according to NFPA 70 (NEC) - Ed. 2020-2023 - Table 400.5(A)(2)

Sezione del conduttore Conductor's size [AWG/kcmil]	Portata massima per Flexible Cords and Cables tipo W, G, G-GC con 2 conduttori alimentati [A] , Temperatura dell'isolamento 90°C <i>Allowable ampacities of Flexible Cords and Cables type W, G, G-GC with 2 current-carrying conductors [A], Insulation temperature 90°C</i>												
	Temperatura ambiente Ta <i>Ambient temperature Ta</i>												
	21÷25°C	26÷30°C	31÷35°C	36÷40°C	41÷45°C	46÷50°C	51÷55°C	56÷60°C	61÷65°C	66÷70°C	71÷75°C	76÷80°C	81÷85°C
12 AWG	43,6	42,0	40,3	38,2	36,5	34,4	31,9	29,8	27,3	24,3	21,0	17,2	12,1
10	61,3	59,0	56,6	53,6	51,3	48,3	44,8	41,8	38,3	34,2	29,5	24,1	17,1
8	76,9	74,0	71,0	67,3	64,3	60,6	56,2	52,5	48,1	42,9	37,0	30,3	21,4
6	102,9	99,0	95,0	90,0	86,1	81,1	75,2	70,2	64,3	57,4	49,5	40,5	28,7
4	135,2	130,0	124,8	118,3	113,1	106,6	98,8	92,3	84,5	75,4	65,0	53,3	37,7
3	158,0	152,0	145,9	138,3	132,2	124,6	115,5	107,9	98,8	88,1	76,0	62,3	44,0
2	180,9	174,0	167,0	158,3	151,3	142,6	132,2	123,5	113,1	100,9	87,0	71,3	50,4
1	210,0	202,0	193,9	183,8	175,7	165,6	153,5	143,4	131,3	117,1	101,0	82,8	58,5
1/0	243,3	234,0	224,6	212,9	203,5	191,8	177,8	166,1	152,1	135,7	117,0	95,9	67,8
2/0	281,8	271,0	260,1	246,6	235,7	222,2	205,9	192,4	176,1	157,1	135,5	111,1	78,5
3/0	325,5	313,0	300,4	284,8	272,3	256,6	237,8	222,2	203,4	181,5	156,5	128,3	90,7
4/0	375,4	361,0	346,5	328,5	314,0	296,0	274,3	256,3	234,6	209,3	180,5	148,0	104,6
250	418,0	402,0	385,9	365,8	349,7	329,6	305,5	285,4	261,3	233,1	201,0	164,8	116,5
300	466,9	449,0	431,0	408,5	390,6	368,1	341,2	318,7	291,8	260,4	224,5	184,0	130,2
350	514,8	495,0	475,2	450,4	430,6	405,9	376,2	351,4	321,7	287,1	247,5	202,9	143,5
400	556,4	535,0	513,6	486,8	465,4	438,7	406,6	379,8	347,7	310,3	267,5	219,3	155,1
500	637,5	613,0	588,4	557,8	533,3	502,6	465,8	435,2	398,4	355,5	306,5	251,3	177,7
600	-	-	-	-	-	-	-	-	-	-	-	-	-
700	-	-	-	-	-	-	-	-	-	-	-	-	-
750	-	-	-	-	-	-	-	-	-	-	-	-	-
800	-	-	-	-	-	-	-	-	-	-	-	-	-
900	-	-	-	-	-	-	-	-	-	-	-	-	-
1000	-	-	-	-	-	-	-	-	-	-	-	-	-

Tabella B.5p. Portata dei Flexible Cords and Cables tipo W, G, G-GC con temperatura dell'isolamento 90°C e 3 conduttori alimentati secondo NFPA 70 (NEC) - Ed. 2020-2023 - Table 400.5(A)(2)
 Table B.5p. Ampacities of Flexible Cords and Cables type W, G, G-GC with 90°C insulation temperature and 3 current-carrying conductors according to NFPA 70 (NEC) - Ed. 2020-2023 - Table 400.5(A)(2)

Sezione del conduttore Conductor's size [AWG/kcmil]	Portata massima per Flexible Cords and Cables tipo W, G, G-GC con 3 conduttori alimentati [A] , Temperatura dell'isolamento 90°C <i>Allowable ampacities of Flexible Cords and Cables type W, G, G-GC with 3 current-carrying conductors [A], Insulation temperature 90°C</i>												
	Temperatura ambiente Ta <i>Ambient temperature Ta</i>												
	21÷25°C	26÷30°C	31÷35°C	36÷40°C	41÷45°C	46÷50°C	51÷55°C	56÷60°C	61÷65°C	66÷70°C	71÷75°C	76÷80°C	81÷85°C
12 AWG	36,4	35,0	33,6	31,8	30,4	28,7	26,6	24,8	22,7	20,3	17,5	14,3	10,1
10	50,9	49,0	47,0	44,5	42,6	40,1	37,2	34,7	31,8	28,4	24,5	20,0	14,2
8	67,6	65,0	62,4	59,1	56,5	53,3	49,4	46,1	42,2	37,7	32,5	26,6	18,8
6	90,4	87,0	83,5	79,1	75,6	71,3	66,1	61,7	56,5	50,4	43,5	35,6	25,2
4	118,5	114,0	109,4	103,7	99,1	93,4	86,6	80,9	74,1	66,1	57,0	46,7	33,0
3	138,3	133,0	127,6	121,0	115,7	109,0	101,0	94,4	86,4	77,1	66,5	54,5	38,5
2	158,0	152,0	145,9	138,3	132,2	124,6	115,5	107,9	98,8	88,1	76,0	62,3	44,0
1	184,0	177,0	169,9	161,0	153,9	145,1	134,5	125,6	115,0	102,6	88,5	72,5	51,3
1/0	213,2	205,0	196,8	186,5	178,3	168,1	155,8	145,5	133,2	118,9	102,5	84,0	59,4
2/0	246,4	237,0	227,5	215,6	206,1	194,3	180,1	168,2	154,0	137,4	118,5	97,1	68,7
3/0	284,9	274,0	263,0	249,3	238,3	224,6	208,2	194,5	178,1	158,9	137,0	112,3	79,4
4/0	328,6	316,0	303,3	287,5	274,9	259,1	240,1	224,3	205,4	183,2	158,0	129,5	91,6
250	366,0	352,0	337,9	320,3	306,2	288,6	267,5	249,9	228,8	204,1	176,0	144,3	102,0
300	408,7	393,0	377,2	357,6	341,9	322,2	298,6	279,0	255,4	227,9	196,5	161,1	113,9
350	450,3	433,0	415,6	394,0	376,7	355,0	329,0	307,4	281,4	251,1	216,5	177,5	125,5
400	486,7	468,0	449,2	425,8	407,1	383,7	355,6	332,2	304,2	271,4	234,0	191,8	135,7
500	557,4	536,0	514,5	487,7	466,3	439,5	407,3	380,5	348,4	310,8	268,0	219,7	155,4
600	-	-	-	-	-	-	-	-	-	-	-	-	-
700	-	-	-	-	-	-	-	-	-	-	-	-	-
750	-	-	-	-	-	-	-	-	-	-	-	-	-
800	-	-	-	-	-	-	-	-	-	-	-	-	-
900	-	-	-	-	-	-	-	-	-	-	-	-	-
1000	-	-	-	-	-	-	-	-	-	-	-	-	-

Tabella B.5q. Portata dei Flexible Cords and Cables tipo W, G, G-GC con temperatura dell'isolamento 90°C e 4÷6 conduttori alimentati secondo NFPA 70 (NEC) - Ed. 2020-2023 - Table 400.5(A)(2)
 Table B.5q. Ampacities of Flexible Cords and Cables type W, G, G-GC with 90°C insulation temperature and 4÷6 current-carrying conductors according to NFPA 70 (NEC) - Ed. 2020-2023 - Table 400.5(A)(2)

Sezione del conduttore Conductor's size [AWG/kcmil]	Portata massima per Flexible Cords and Cables tipo W, G, G-GC con 4÷6 conduttori alimentati [A] , Temperatura dell'isolamento 90°C <i>Allowable ampacities of Flexible Cords and Cables type W, G, G-GC with 4÷6 current-carrying conductors [A], Insulation temperature 90°C</i>												
	Temperatura ambiente Ta <i>Ambient temperature Ta</i>												
	21÷25°C	26÷30°C	31÷35°C	36÷40°C	41÷45°C	46÷50°C	51÷55°C	56÷60°C	61÷65°C	66÷70°C	71÷75°C	76÷80°C	81÷85°C
12 AWG	29,1	28,0	26,8	25,4	24,3	22,9	21,2	19,8	18,2	16,2	14,0	11,4	8,1
10	40,7	39,2	37,6	35,6	34,1	32,1	29,7	27,8	25,4	22,7	19,6	16,0	11,3
8	54,0	52,0	49,9	47,3	45,2	42,6	39,5	36,9	33,8	30,1	26,0	21,3	15,0
6	72,3	69,6	66,8	63,3	60,5	57,0	52,8	49,4	45,2	40,3	34,8	28,5	20,1
4	94,8	91,2	87,5	82,9	79,3	74,7	69,3	64,7	59,2	52,8	45,6	37,3	26,4
3	110,6	106,4	102,1	96,8	92,5	87,2	80,8	75,5	69,1	61,7	53,2	43,6	30,8
2	126,4	121,6	116,7	110,6	105,7	99,7	92,4	86,3	79,0	70,5	60,8	49,8	35,2
1	147,2	141,6	135,9	128,8	123,1	116,1	107,6	100,5	92,0	82,1	70,8	58,0	41,0
1/0	170,5	164,0	157,4	149,2	142,6	134,4	124,6	116,4	106,6	95,1	82,0	67,2	47,5
2/0	197,1	189,6	182,0	172,5	164,9	155,4	144,0	134,6	123,2	109,9	94,8	77,7	54,9
3/0	227,9	219,2	210,4	199,4	190,7	179,7	166,5	155,6	142,4	127,1	109,6	89,8	63,5
4/0	262,9	252,8	242,6	230,0	219,9	207,2	192,1	179,4	164,3	146,6	126,4	103,6	73,3
250	292,8	281,6	270,3	256,2	244,9	230,9	214,0	199,9	183,0	163,3	140,8	115,4	81,6
300	326,9	314,4	301,8	286,1	273,5	257,8	238,9	223,2	204,3	182,3	157,2	128,9	91,1
350	360,2	346,4	332,5	315,2	301,3	284,0	263,2	245,9	225,1	200,9	173,2	142,0	100,4
400	389,3	374,4	359,4	340,7	325,7	307,0	284,5	265,8	243,3	217,1	187,2	153,5	108,5
500	445,9	428,8	411,6	390,2	373,0	351,6	325,8	304,4	278,7	248,7	214,4	175,8	124,3
600	-	-	-	-	-	-	-	-	-	-	-	-	-
700	-	-	-	-	-	-	-	-	-	-	-	-	-
750	-	-	-	-	-	-	-	-	-	-	-	-	-
800	-	-	-	-	-	-	-	-	-	-	-	-	-
900	-	-	-	-	-	-	-	-	-	-	-	-	-
1000	-	-	-	-	-	-	-	-	-	-	-	-	-

B.6 Portate dei conduttori secondo CSA C22.1 (CE Code) Ampacity of conductors according to CSA C22.1 (CE Code)

Le tabelle mostrano le portate dei conduttori pubblicate nella norma alla quale si deve fare sempre riferimento.
The tables show the ampacities of the conductors published in the standard to which reference must always be made.

Portate dei conduttori in aria libera secondo CSA C22.1 (CE Code) Ampacity of conductors in free air according to CSA C22.1 (CE Code)

Tabella B.6a. Portata dei conduttori in aria libera con temperatura dell'isolamento 60°C secondo CSA C22.1 (CE Code) – Ed. 2015-2021 (Table 1)
Table B.6a. Ampacities of conductors in free air with 60°C insulation temperature according to CSA C22.1 (CE Code) – Ed. 2015-2021 (Table 1)

Sezione del conduttore Conductor's size [AWG/kcmil]	Portata massima per conduttori in rame isolati [A], per tensioni non superiori a 5000V, in aria libera Temperatura dell'isolamento 60°C Allowable ampacities of insulated copper conductors [A], rated not more than 5000V, in free air Insulation temperature 60°C											
	Temperatura ambiente Ta Ambient temperature Ta											
	30°C	31÷35°C	36÷40°C	41÷45°C	46÷50°C	51÷55°C	56÷60°C	61÷65°C	66÷70°C	71÷75°C	76÷80°C	
14 AWG	25,0	22,7	20,5	17,7	14,5	10,2	-	-	-	-	-	
12	30,0	27,3	24,6	21,3	17,4	12,3	-	-	-	-	-	
10	40,0	36,4	32,8	28,4	23,2	16,4	-	-	-	-	-	
8	60,0	54,6	49,2	42,6	34,8	24,6	-	-	-	-	-	
6	80,0	72,8	65,6	56,8	46,4	32,8	-	-	-	-	-	
4	105,0	95,5	86,1	74,5	60,9	43,0	-	-	-	-	-	
3	120,0	109,2	98,4	85,2	69,6	49,2	-	-	-	-	-	
2	140,0	127,4	114,8	99,4	81,2	57,4	-	-	-	-	-	
1	165,0	150,1	135,3	117,1	95,7	67,6	-	-	-	-	-	
1/0	195,0	177,4	159,9	138,4	113,1	79,9	-	-	-	-	-	
2/0	220,0	200,2	180,4	156,2	127,6	90,2	-	-	-	-	-	
3/0	260,0	236,6	213,2	184,6	150,8	106,6	-	-	-	-	-	
4/0	300,0	273,0	246,0	213,0	174,0	123,0	-	-	-	-	-	
250 kcmil	340,0	309,4	278,8	241,4	197,2	139,4	-	-	-	-	-	
300	370,0	336,7	303,4	262,7	214,6	151,7	-	-	-	-	-	
350	425,0	386,7	348,5	301,7	246,5	174,2	-	-	-	-	-	
400	455,0	414,0	373,1	323,0	263,9	186,5	-	-	-	-	-	
500	520,0	473,2	426,4	369,2	301,6	213,2	-	-	-	-	-	
600	580,0	527,8	475,6	411,8	336,4	237,8	-	-	-	-	-	
700	630,0	573,3	516,6	447,3	365,4	258,3	-	-	-	-	-	
750	655,0	596,0	537,1	465,0	379,9	268,5	-	-	-	-	-	
800	680,0	618,8	557,6	482,8	394,4	278,8	-	-	-	-	-	
900	730,0	664,3	598,6	518,3	423,4	299,3	-	-	-	-	-	
1000	785,0	714,3	643,7	557,3	455,3	321,8	-	-	-	-	-	
1250	890,0	809,9	729,8	631,9	516,2	364,9	-	-	-	-	-	
1500	985,0	896,3	807,7	699,3	571,3	403,8	-	-	-	-	-	
1750	1070,0	973,7	877,4	759,7	620,6	438,7	-	-	-	-	-	
2000	1160,0	1055,6	951,2	823,6	672,8	475,6	-	-	-	-	-	

Tabella B.6b. Portata dei conduttori in aria libera con temperatura dell'isolamento 75°C secondo CSA C22.1 (CE Code) – Ed. 2015-2021 (Table 1)

Table B.6b. Ampacities of conductors in free air with 75°C insulation temperature according to CSA C22.1 (CE Code) – Ed. 2015-2021 (Table 1)

Sezione del conduttore Conductor's size [AWG/kcmil]	Portata massima per conduttori in rame isolati [A], per tensioni non superiori a 5000V, in aria libera Temperatura dell'isolamento 75°C Allowable ampacities of insulated copper conductors [A], rated not more than 5000V, in free air Insulation temperature 75°C											
	Temperatura ambiente Ta Ambient temperature Ta											
	30°C	31÷35°C	36÷40°C	41÷45°C	46÷50°C	51÷55°C	56÷60°C	61÷65°C	66÷70°C	71÷75°C	76÷80°C	
14 AWG	30,0	28,2	26,4	24,6	22,5	20,1	17,4	14,1	9,9	-	-	
12	35,0	32,9	30,8	28,7	26,2	23,4	20,3	16,4	11,5	-	-	
10	50,0	47,0	44,0	41,0	37,5	33,5	29,0	23,5	16,5	-	-	
8	70,0	65,8	61,6	57,4	52,5	46,9	40,6	32,9	23,1	-	-	
6	95,0	89,3	83,6	77,9	71,2	63,6	55,1	44,6	31,3	-	-	
4	125,0	117,5	110,0	102,5	93,7	83,7	72,5	58,7	41,2	-	-	
3	145,0	136,3	127,6	118,9	108,7	97,1	84,1	68,1	47,8	-	-	
2	170,0	159,8	149,6	139,4	127,5	113,9	98,6	79,9	56,1	-	-	
1	195,0	183,3	171,6	159,9	146,2	130,6	113,1	91,6	64,3	-	-	
1/0	230,0	216,2	202,4	188,6	172,5	154,1	133,4	108,1	75,9	-	-	
2/0	265,0	249,1	233,2	217,3	198,7	177,5	153,7	124,5	87,4	-	-	
3/0	310,0	291,4	272,8	254,2	232,5	207,7	179,8	145,7	102,3	-	-	
4/0	360,0	338,4	316,8	295,2	270,0	241,2	208,8	169,2	118,8	-	-	
250 kcmil	405,0	380,7	356,4	332,1	303,7	271,3	234,9	190,3	133,6	-	-	
300	445,0	418,3	391,6	364,9	333,7	298,1	258,1	209,1	146,8	-	-	
350	505,0	474,7	444,4	414,1	378,7	338,3	292,9	237,3	166,6	-	-	
400	545,0	512,3	479,6	446,9	408,7	365,1	316,1	256,1	179,8	-	-	
500	620,0	582,8	545,6	508,4	465,0	415,4	359,6	291,4	204,6	-	-	
600	690,0	648,6	607,2	565,8	517,5	462,3	400,2	324,3	227,7	-	-	
700	755,0	709,7	664,4	619,1	566,2	505,8	437,9	354,8	249,1	-	-	
750	785,0	737,9	690,8	643,7	588,7	525,9	455,3	368,9	259,0	-	-	
800	815,0	766,1	717,2	668,3	611,2	546,0	472,7	383,0	268,9	-	-	
900	870,0	817,8	765,6	713,4	652,5	582,9	504,6	408,9	287,1	-	-	
1000	935,0	878,9	822,8	766,7	701,2	626,4	542,3	439,4	308,5	-	-	
1250	1065,0	1001,1	937,2	873,3	798,7	713,5	617,7	500,5	351,4	-	-	
1500	1175,0	1104,5	1034,0	963,5	881,2	787,2	681,5	552,2	387,7	-	-	
1750	1280,0	1203,2	1126,4	1049,6	960,0	857,6	742,4	601,6	422,4	-	-	
2000	1385,0	1301,9	1218,8	1135,7	1038,7	927,9	803,3	650,9	457,0	-	-	

Tabella B.6c. Portata dei conduttori in aria libera con temperatura dell'isolamento 90°C secondo CSA C22.1 (CE Code) – Ed. 2015-2021 (Table 1)

Table B.6c. Ampacities of conductors in free air with 90°C insulation temperature according to CSA C22.1 (CE Code) – Ed. 2015-2021 (Table 1)

Sezione del conduttore Conductor's size [AWG/kcmil]	Portata massima per conduttori in rame isolati [A], per tensioni non superiori a 5000V, in aria libera Temperatura dell'isolamento 90°C <i>Allowable ampacities of insulated copper conductors [A], rated not more than 5000V, in free air Insulation temperature 90°C</i>											
	Temperatura ambiente Ta <i>Ambient temperature Ta</i>											
	30°C	31÷35°C	36÷40°C	41÷45°C	46÷50°C	51÷55°C	56÷60°C	61÷65°C	66÷70°C	71÷75°C	76÷80°C	
14 AWG	35,0	33,6	31,8	30,4	28,7	26,6	24,8	22,7	20,3	17,5	14,3	
12	40,0	38,4	36,4	34,8	32,8	30,4	28,4	26,0	23,2	20,0	16,4	
10	55,0	52,8	50,0	47,8	45,1	41,8	39,0	35,7	31,9	27,5	22,5	
8	80,0	76,8	72,8	69,6	65,6	60,8	56,8	52,0	46,4	40,0	32,8	
6	105,0	100,8	95,5	91,3	86,1	79,8	74,5	68,2	60,9	52,5	43,0	
4	140,0	134,4	127,4	121,8	114,8	106,4	99,4	91,0	81,2	70,0	57,4	
3	165,0	158,4	150,1	143,5	135,3	125,4	117,1	107,2	95,7	82,5	67,6	
2	190,0	182,4	172,9	165,3	155,8	144,4	134,9	123,5	110,2	95,0	77,9	
1	220,0	211,2	200,2	191,4	180,4	167,2	156,2	143,0	127,6	110,0	90,2	
1/0	260,0	249,6	236,6	226,2	213,2	197,6	184,6	169,0	150,8	130,0	106,6	
2/0	300,0	288,0	273,0	261,0	246,0	228,0	213,0	195,0	174,0	150,0	123,0	
3/0	350,0	336,0	318,5	304,5	287,0	266,0	248,5	227,5	203,0	175,0	143,5	
4/0	405,0	388,8	368,5	352,3	332,1	307,8	287,5	263,2	234,9	202,5	166,0	
250 kcmil	455,0	436,8	414,0	395,8	373,1	345,8	323,0	295,7	263,9	227,5	186,5	
300	500,0	480,0	455,0	435,0	410,0	380,0	355,0	325,0	290,0	250,0	205,0	
350	570,0	547,2	518,7	495,9	467,4	433,2	404,7	370,5	330,6	285,0	233,7	
400	615,0	590,4	559,6	535,0	504,3	467,4	436,6	399,7	356,7	307,5	252,1	
500	700,0	672,0	637,0	609,0	574,0	532,0	497,0	455,0	406,0	350,0	287,0	
600	780,0	748,8	709,8	678,6	639,6	592,8	553,8	507,0	452,4	390,0	319,8	
700	850,0	816,0	773,5	739,5	697,0	646,0	603,5	552,5	493,0	425,0	348,5	
750	885,0	849,6	805,3	769,9	725,7	672,6	628,3	575,2	513,3	442,5	362,8	
800	920,0	883,2	837,2	800,4	754,4	699,2	653,2	598,0	533,6	460,0	377,2	
900	980,0	940,8	891,8	852,6	803,6	744,8	695,8	637,0	568,4	490,0	401,8	
1000	1055,0	1012,8	960,0	917,8	865,1	801,8	749,0	685,7	611,9	527,5	432,5	
1250	1200,0	1152,0	1092,0	1044,0	984,0	912,0	852,0	780,0	696,0	600,0	492,0	
1500	1325,0	1272,0	1205,7	1152,7	1086,5	1007,0	940,7	861,2	768,5	662,5	543,2	
1750	1445,0	1387,2	1314,9	1257,1	1184,9	1098,2	1025,9	939,2	838,1	722,5	592,4	
2000	1560,0	1497,6	1419,6	1357,2	1279,2	1185,6	1107,6	1014,0	904,8	780,0	639,6	

Tabella B.6d. Portata dei conduttori in aria libera con temperatura dell'isolamento 110°C secondo CSA C22.1 (CE Code) – Ed. 2015-2021 (Table 1)
 Table B.6d. Ampacities of conductors in free air with 110°C insulation temperature according to CSA C22.1 (CE Code) – Ed. 2015-2021 (Table 1)

Sezione del conduttore Conductor's size [AWG/kcmil]	Portata massima per conduttori in rame isolati [A], temperatura dell'isolamento 110°C per tensioni non superiori a 5000V, in aria libera, temperatura ambiente Ta, Allowable ampacities of insulated copper conductors [A], rated not more than 5000V, in free air, Ambient temperature Ta, Insulation temperature 110°C																
	Temperatura ambiente Ta Ambient temperature Ta																
	30°C	31÷35°C	36÷40°C	41÷45°C	46÷50°C	51÷55°C	56÷60°C	61÷65°C	66÷70°C	71÷75°C	76÷80°C	81÷90°C	91÷100°C	101÷110°C	111÷120°C	121÷130°C	131÷140°C
14AWG	40,0	38,8	37,6	36,0	34,8	33,2	31,6	30,0	28,4	26,4	24,4	20,0	14,0	-	-	-	-
12	45,0	43,6	42,3	40,5	39,1	37,3	35,5	33,7	31,9	29,7	27,4	22,5	15,7	-	-	-	-
10	65,0	63,0	61,1	58,5	56,5	53,9	51,3	48,7	46,1	42,9	39,6	32,5	22,7	-	-	-	-
8	90,0	87,3	84,6	81,0	78,3	74,7	71,1	67,5	63,9	59,4	54,9	45,0	31,5	-	-	-	-
6	120,0	116,4	112,8	108,0	104,4	99,6	94,8	90,0	85,2	79,2	73,2	60,0	42,0	-	-	-	-
4	160,0	155,2	150,4	144,0	139,2	132,8	126,4	120,0	113,6	105,6	97,6	80,0	56,0	-	-	-	-
3	185,0	179,4	173,9	166,5	160,9	153,5	146,1	138,7	131,3	122,1	112,8	92,5	64,7	-	-	-	-
2	215,0	208,5	202,1	193,5	187,0	178,4	169,8	161,2	152,6	141,9	131,1	107,5	75,2	-	-	-	-
1	245,0	237,6	230,3	220,5	213,1	203,3	193,5	183,7	173,9	161,7	149,4	122,5	85,7	-	-	-	-
1/0	290,0	281,3	272,6	261,0	252,3	240,7	229,1	217,5	205,9	191,4	176,9	145,0	101,5	-	-	-	-
2/0	335,0	324,9	314,9	301,5	291,4	278,0	264,6	251,2	237,8	221,1	204,3	167,5	117,2	-	-	-	-
3/0	390,0	378,3	366,6	351,0	339,3	323,7	308,1	292,5	276,9	257,4	237,9	195,0	136,5	-	-	-	-
4/0	455,0	441,3	427,7	409,5	395,8	377,6	359,4	341,2	323,0	300,3	277,5	227,5	159,2	-	-	-	-
250 kcmil	510,0	494,7	479,4	459,0	443,7	423,3	402,9	382,5	362,1	336,6	311,1	255,0	178,5	-	-	-	-
300	560,0	543,2	526,4	504,0	487,2	464,8	442,4	420,0	397,6	369,6	341,6	280,0	196,0	-	-	-	-
350	640,0	620,8	601,6	576,0	556,8	531,2	505,6	480,0	454,4	422,4	390,4	320,0	224,0	-	-	-	-
400	690,0	669,3	648,6	621,0	600,3	572,7	545,1	517,5	489,9	455,4	420,9	345,0	241,5	-	-	-	-
500	785,0	761,4	737,9	706,5	682,9	651,5	620,1	588,7	557,3	518,1	478,8	392,5	274,7	-	-	-	-
600	870,0	843,9	817,8	783,0	756,9	722,1	687,3	652,5	617,7	574,2	530,7	435,0	304,5	-	-	-	-
700	955,0	926,3	897,7	859,5	830,8	792,6	754,4	716,2	678,0	630,3	582,5	477,5	334,2	-	-	-	-
750	990,0	960,3	930,6	891,0	861,3	821,7	782,1	742,5	702,9	653,4	603,9	495,0	346,5	-	-	-	-
800	1030,0	999,1	968,2	927,0	896,1	854,9	813,7	772,5	731,3	679,8	628,3	515,0	360,5	-	-	-	-
900	1100,0	1067,0	1034,0	990,0	957,0	913,0	869,0	825,0	781,0	726,0	671,0	550,0	385,0	-	-	-	-
1000	1180,0	1144,6	1109,2	1062,0	1026,6	979,4	932,2	885,0	837,8	778,8	719,8	590,0	413,0	-	-	-	-
1250	1345,0	1304,6	1264,3	1210,5	1170,1	1116,3	1062,5	1008,7	954,9	887,7	820,4	672,5	470,7	-	-	-	-
1500	1485,0	1440,4	1395,9	1336,5	1291,9	1232,5	1173,1	1113,7	1054,3	980,1	905,8	742,5	519,7	-	-	-	-
1750	1620,0	1571,4	1522,8	1458,0	1409,4	1344,6	1279,8	1215,0	1150,2	1069,2	988,2	810,0	567,0	-	-	-	-
2000	1750,0	1697,5	1645,0	1575,0	1522,5	1452,5	1382,5	1312,5	1242,5	1155,0	1067,5	875,0	612,5	-	-	-	-

Tabella B.6e. Portata dei conduttori in aria libera con temperatura dell'isolamento 125°C secondo CSA C22.1 (CE Code) – Ed. 2015-2021 (Table 1)
 Table B.6e. Ampacities of conductors in free air with 125°C insulation temperature according to CSA C22.1 (CE Code) – Ed. 2015-2021 (Table 1)

Sezione del conduttore Conductor's size [AWG/kcmil]	Portata massima per conduttori in rame isolati [A], temperatura dell'isolamento 125°C per tensioni non superiori a 5000V, in aria libera, temperatura ambiente Ta. Allowable ampacities of insulated copper conductors [A], rated not more than 5000V, in free air, Ambient temperature Ta, Insulation temperature 125°C																
	Temperatura ambiente Ta Ambient temperature Ta																
	30°C	31÷35°C	36÷40°C	41÷45°C	46÷50°C	51÷55°C	56÷60°C	61÷65°C	66÷70°C	71÷75°C	76÷80°C	81÷90°C	91÷100°C	101÷110°C	111÷120°C	121÷130°C	131÷140°C
14 AWG	40,0	38,8	38,0	36,8	35,6	34,4	33,2	31,6	30,4	29,2	27,6	24,4	20,4	16,0	9,2	-	-
12	45,0	43,6	42,7	41,4	40,0	38,7	37,3	35,5	34,2	32,8	31,0	27,4	22,9	18,0	10,3	-	-
10	65,0	63,0	61,7	59,8	57,8	55,9	53,9	51,3	49,4	47,4	44,8	39,6	33,1	26,0	14,9	-	-
8	95,0	92,1	90,2	87,4	84,5	81,7	78,8	75,0	72,2	69,3	65,5	57,9	48,4	38,0	21,8	-	-
6	130,0	126,1	123,5	119,6	115,7	111,8	107,9	102,7	98,8	94,9	89,7	79,3	66,3	52,0	29,9	-	-
4	170,0	164,9	161,5	156,4	151,3	146,2	141,1	134,3	129,2	124,1	117,3	103,7	86,7	68,0	39,1	-	-
3	195,0	189,1	185,2	179,4	173,5	167,7	161,8	154,0	148,2	142,3	134,5	118,9	99,4	78,0	44,8	-	-
2	230,0	223,1	218,5	211,6	204,7	197,8	190,9	181,7	174,8	167,9	158,7	140,3	117,3	92,0	52,9	-	-
1	265,0	257,0	251,7	243,8	235,8	227,9	219,9	209,3	201,4	193,4	182,8	161,6	135,1	106,0	60,9	-	-
1/0	310,0	300,7	294,5	285,2	275,9	266,6	257,3	244,9	235,6	226,3	213,9	189,1	158,1	124,0	71,3	-	-
2/0	355,0	344,3	337,2	326,6	315,9	305,3	294,6	280,4	269,8	259,1	244,9	216,5	181,0	142,0	81,6	-	-
3/0	420,0	407,4	399,0	386,4	373,8	361,2	348,6	331,8	319,2	306,6	289,8	256,2	214,2	168,0	96,6	-	-
4/0	485,0	470,4	460,7	446,2	431,6	417,1	402,5	383,1	368,6	354,0	334,6	295,8	247,3	194,0	111,5	-	-
250 kcmil	545,0	528,6	517,7	501,4	485,0	468,7	452,3	430,5	414,2	397,8	376,0	332,4	277,9	218,0	125,3	-	-
300	600,0	582,0	570,0	552,0	534,0	516,0	498,0	474,0	456,0	438,0	414,0	366,0	306,0	240,0	138,0	-	-
350	680,0	659,6	646,0	625,6	605,2	584,8	564,4	537,2	516,8	496,4	469,2	414,8	346,8	272,0	156,4	-	-
400	735,0	712,9	698,2	676,2	654,1	632,1	610,0	580,6	558,6	536,5	507,1	448,3	374,8	294,0	169,0	-	-
500	835,0	809,9	793,2	768,2	743,1	718,1	693,0	659,6	634,6	609,5	576,1	509,3	425,8	334,0	192,0	-	-
600	930,0	902,1	883,5	855,6	827,7	799,8	771,9	734,7	706,8	678,9	641,7	567,3	474,3	372,0	213,9	-	-
700	1020,0	989,4	969,0	938,4	907,8	877,2	846,6	805,8	775,2	744,6	703,8	622,2	520,2	408,0	234,6	-	-
750	1060,0	1028,2	1007,0	975,2	943,4	911,6	879,8	837,4	805,6	773,8	731,4	646,6	540,6	424,0	243,8	-	-
800	1100,0	1067,0	1045,0	1012,0	979,0	946,0	913,0	869,0	836,0	803,0	759,0	671,0	561,0	440,0	253,0	-	-
900	1175,0	1139,7	1116,2	1081,0	1045,7	1010,5	975,2	928,2	893,0	857,7	810,7	716,7	599,2	470,0	270,2	-	-
1000	1260,0	1222,2	1197,0	1159,2	1121,4	1083,6	1045,8	995,4	957,6	919,8	869,4	768,6	642,6	504,0	289,8	-	-
1250	-	-	-	-	-	-	-	-	-	-	-	-	-	-	-	-	-
1500	-	-	-	-	-	-	-	-	-	-	-	-	-	-	-	-	-
1750	-	-	-	-	-	-	-	-	-	-	-	-	-	-	-	-	-
2000	-	-	-	-	-	-	-	-	-	-	-	-	-	-	-	-	-

Tabella B.6f. Portata dei conduttori in aria libera con temperatura dell'isolamento 200°C secondo CSA C22.1 (CE Code) – Ed. 2015-2021 (Table 1)
 Table B.6f. Ampacities of conductors in free air with 200°C insulation temperature according to CSA C22.1 (CE Code) – Ed. 2015-2021 (Table 1)

Sezione del conduttore Conductor's size [AWG/kcmil]	Portata massima per conduttori in rame isolati [A], temperatura dell'isolamento 200°C per tensioni non superiori a 5000V, in aria libera, temperatura ambiente Ta, Allowable ampacities of insulated copper conductors [A], rated not more than 5000V, in free air, Ambient temperature Ta, Insulation temperature 200°C																
	Temperatura ambiente Ta Ambient temperature Ta																
	30°C	31÷35°C	36÷40°C	41÷45°C	46÷50°C	51÷55°C	56÷60°C	61÷65°C	66÷70°C	71÷75°C	76÷80°C	81÷90°C	91÷100°C	101÷110°C	111÷120°C	121÷130°C	131÷140°C
14 AWG	50,0	49,5	48,5	47,5	47,0	46,0	45,5	44,5	43,5	43,0	42,0	40,0	38,5	36,5	34,5	32,0	29,5
12	55,0	54,4	53,3	52,2	51,7	50,6	48,9	47,8	47,3	46,2	44,0	42,3	40,1	37,9	35,2	32,4	29,5
10	80,0	79,2	77,6	76,0	75,2	73,6	72,8	71,2	69,6	68,8	67,2	64,0	61,6	58,4	55,2	51,2	47,2
8	115,0	113,8	111,5	109,2	108,1	105,8	104,6	102,3	100,0	98,9	96,6	92,0	88,5	83,9	79,3	73,6	67,8
6	155,0	153,4	150,3	147,2	145,7	142,6	141,0	137,9	134,8	133,3	130,2	124,0	119,3	113,1	106,9	99,2	91,4
4	205,0	202,9	198,8	194,7	192,7	188,6	186,5	182,4	178,3	176,3	172,2	164,0	157,8	149,6	141,4	131,2	120,9
3	240,0	237,6	232,8	228,0	225,6	220,8	218,4	213,6	208,8	206,4	201,6	192,0	184,8	175,2	165,6	153,6	141,6
2	280,0	277,2	271,6	266,0	263,2	257,6	254,8	249,2	243,6	240,8	235,2	224,0	215,6	204,4	193,2	179,2	165,2
1	320,0	316,8	310,4	304,0	300,8	294,4	291,2	284,8	278,4	275,2	268,8	256,0	246,4	233,6	220,8	204,8	188,8
1/0	375,0	371,2	363,7	356,2	352,5	345,0	341,2	333,7	326,2	322,5	315,0	300,0	288,7	273,7	258,7	240,0	221,2
2/0	435,0	430,6	421,9	413,2	408,9	400,2	395,8	387,1	378,4	374,1	365,4	348,0	334,9	317,5	300,1	278,4	256,6
3/0	510,0	504,9	494,7	484,5	479,4	469,2	464,1	453,9	443,7	438,6	428,4	408,0	392,7	372,3	351,9	326,4	300,9
4/0	590,0	584,1	572,3	560,5	554,6	542,8	536,9	525,1	513,3	507,4	495,6	472,0	454,3	430,7	407,1	377,6	348,1
250 kcmil	-	-	-	-	-	-	-	-	-	-	-	-	-	-	-	-	-
300	-	-	-	-	-	-	-	-	-	-	-	-	-	-	-	-	-
350	-	-	-	-	-	-	-	-	-	-	-	-	-	-	-	-	-
400	-	-	-	-	-	-	-	-	-	-	-	-	-	-	-	-	-
500	-	-	-	-	-	-	-	-	-	-	-	-	-	-	-	-	-
600	-	-	-	-	-	-	-	-	-	-	-	-	-	-	-	-	-
700	-	-	-	-	-	-	-	-	-	-	-	-	-	-	-	-	-
750	-	-	-	-	-	-	-	-	-	-	-	-	-	-	-	-	-
800	-	-	-	-	-	-	-	-	-	-	-	-	-	-	-	-	-
900	-	-	-	-	-	-	-	-	-	-	-	-	-	-	-	-	-
1000	-	-	-	-	-	-	-	-	-	-	-	-	-	-	-	-	-
1250	-	-	-	-	-	-	-	-	-	-	-	-	-	-	-	-	-
1500	-	-	-	-	-	-	-	-	-	-	-	-	-	-	-	-	-
1750	-	-	-	-	-	-	-	-	-	-	-	-	-	-	-	-	-
2000	-	-	-	-	-	-	-	-	-	-	-	-	-	-	-	-	-

Tabella B.6g. Fattori di correzione delle portate indicate nelle tabelle precedenti in funzione del numero di conduttori.

Si applica quando lo spazio fra i cavi è inferiore al 25% del diametro cavo più grande. Valori secondo CSA C22.1 (CE Code) – Ed. 2015-2021 (Table 5B)

Table B.6g. Adjustment factors for the ampacities indicated in the previous tables and based on the number of *c* conductors.

It applies when the space between cables is less than 25% of the largest cable diameter. Values according to CSA C22.1 (CE Code) – Ed. 2015-2021 (Table 5B)

Numero di conduttori <i>Number of conductors</i>	Coefficiente di correzione <i>Correction factor</i>
2	0,90
3	0,85
4	0,80

Nota. Quando sono presenti più di quattro cavi, le portate da considerare sono quelle indicate nelle tabelle successive per conduttori in canalina o in cavo.

Note. Where more than four conductors are in contact, the ratings for conductors in raceways shall be used.

Portate dei conduttori in canalina o in cavo secondo CSA C22.1 (CE Code) Ampacity of conductors in raceway or cable according to CSA C22.1 (CE Code)

Tabella B.6h. Portata dei conduttori in canalina o in cavo con temperatura dell'isolamento 60°C secondo CSA C22.1 (CE Code) – Ed. 2015-2021 (Table 2)

Table B.6h. Ampacities of conductors in raceway or cable with 60°C insulation temperature according to CSA C22.1 (CE Code) – Ed. 2015-2021 (Table 2)

Sezione del conduttore Conductor's size [AWG/kcmil]	Portata massima per conduttori in rame isolati [A], per tensioni non superiori a 5000V, in canalina o in cavo Temperatura dell'isolamento 60°C Allowable ampacities of insulated copper conductors [A], rated not more than 5000V, in raceway or cable Insulation temperature 60°C											
	Temperatura ambiente Ta Ambient temperature Ta											
	30°C	31÷35°C	36÷40°C	41÷45°C	46÷50°C	51÷55°C	56÷60°C	61÷65°C	66÷70°C	71÷75°C	76÷80°C	
14 AWG	15,0	13,6	12,3	10,6	8,7	6,1	-	-	-	-	-	
12	20,0	18,2	16,4	14,2	11,6	8,2	-	-	-	-	-	
10	30,0	27,3	24,6	21,3	17,4	12,3	-	-	-	-	-	
8	40,0	36,4	32,8	28,4	23,2	16,4	-	-	-	-	-	
6	55,0	50,0	45,1	39,0	31,9	22,5	-	-	-	-	-	
4	70,0	63,7	57,4	49,7	40,6	28,7	-	-	-	-	-	
3	85,0	77,3	69,7	60,3	49,3	34,8	-	-	-	-	-	
2	95,0	86,4	77,9	67,4	55,1	38,9	-	-	-	-	-	
1	110,0	100,1	90,2	78,1	63,8	45,1	-	-	-	-	-	
1/0	125,0	113,7	102,5	88,7	72,5	51,2	-	-	-	-	-	
2/0	145,0	131,9	118,9	102,9	84,1	59,4	-	-	-	-	-	
3/0	165,0	150,1	135,3	117,1	95,7	67,6	-	-	-	-	-	
4/0	195,0	177,4	159,9	138,4	113,1	79,9	-	-	-	-	-	
250 kcmil	215,0	195,6	176,3	152,6	124,7	88,1	-	-	-	-	-	
300	240,0	218,4	196,8	170,4	139,2	98,4	-	-	-	-	-	
350	260,0	236,6	213,2	184,6	150,8	106,6	-	-	-	-	-	
400	280,0	254,8	229,6	198,8	162,4	114,8	-	-	-	-	-	
500	320,0	291,2	262,4	227,2	185,6	131,2	-	-	-	-	-	
600	350,0	318,5	287,0	248,5	203,0	143,5	-	-	-	-	-	
700	385,0	350,3	315,7	273,3	223,3	157,8	-	-	-	-	-	
750	400,0	364,0	328,0	284,0	232,0	164,0	-	-	-	-	-	
800	410,0	373,1	336,2	291,1	237,8	168,1	-	-	-	-	-	
900	435,0	395,8	356,7	308,8	252,3	178,3	-	-	-	-	-	
1000	455,0	414,0	373,1	323,0	263,9	186,5	-	-	-	-	-	
1250	495,0	450,4	405,9	351,4	287,1	202,9	-	-	-	-	-	
1500	525,0	477,7	430,5	372,7	304,5	215,2	-	-	-	-	-	
1750	545,0	495,9	446,9	386,9	316,1	223,4	-	-	-	-	-	
2000	555,0	505,0	455,1	394,0	321,9	227,5	-	-	-	-	-	

Tabella B.6i. Portata dei conduttori in canalina o in cavo con temperatura dell'isolamento 75°C secondo CSA C22.1 (CE Code) – Ed. 2015-2021 (Table 2)

Table B.6i. Ampacities of conductors in raceway or cable with 75°C insulation temperature according to CSA C22.1 (CE Code) – Ed. 2015-2021 (Table 2)

Sezione del conduttore Conductor's size [AWG/kcmil]	Portata massima per conduttori in rame isolati [A], per tensioni non superiori a 5000V, in canalina o in cavo Temperatura dell'isolamento 75°C Allowable ampacities of insulated copper conductors [A], rated not more than 5000V, in raceway or cable Insulation temperature 75°C											
	Temperatura ambiente Ta Ambient temperature Ta											
	30°C	31÷35°C	36÷40°C	41÷45°C	46÷50°C	51÷55°C	56÷60°C	61÷65°C	66÷70°C	71÷75°C	76÷80°C	
14 AWG	20,0	18,8	17,6	16,4	15,0	13,4	11,6	9,4	6,6	-	-	
12	25,0	23,5	22,0	20,5	18,7	16,7	14,5	11,7	8,2	-	-	
10	35,0	32,9	30,8	28,7	26,2	23,4	20,3	16,4	11,5	-	-	
8	50,0	47,0	44,0	41,0	37,5	33,5	29,0	23,5	16,5	-	-	
6	65,0	61,1	57,2	53,3	48,7	43,5	37,7	30,5	21,4	-	-	
4	85,0	79,9	74,8	69,7	63,7	56,9	49,3	39,9	28,0	-	-	
3	100,0	94,0	88,0	82,0	75,0	67,0	58,0	47,0	33,0	-	-	
2	115,0	108,1	101,2	94,3	86,2	77,0	66,7	54,0	37,9	-	-	
1	130,0	122,2	114,4	106,6	97,5	87,1	75,4	61,1	42,9	-	-	
1/0	150,0	141,0	132,0	123,0	112,5	100,5	87,0	70,5	49,5	-	-	
2/0	175,0	164,5	154,0	143,5	131,2	117,2	101,5	82,2	57,7	-	-	
3/0	200,0	188,0	176,0	164,0	150,0	134,0	116,0	94,0	66,0	-	-	
4/0	230,0	216,2	202,4	188,6	172,5	154,1	133,4	108,1	75,9	-	-	
250 kcmil	255,0	239,7	224,4	209,1	191,2	170,8	147,9	119,8	84,1	-	-	
300	285,0	267,9	250,8	233,7	213,7	190,9	165,3	133,9	94,0	-	-	
350	310,0	291,4	272,8	254,2	232,5	207,7	179,8	145,7	102,3	-	-	
400	335,0	314,9	294,8	274,7	251,2	224,4	194,3	157,4	110,5	-	-	
500	380,0	357,2	334,4	311,6	285,0	254,6	220,4	178,6	125,4	-	-	
600	420,0	394,8	369,6	344,4	315,0	281,4	243,6	197,4	138,6	-	-	
700	460,0	432,4	404,8	377,2	345,0	308,2	266,8	216,2	151,8	-	-	
750	475,0	446,5	418,0	389,5	356,2	318,2	275,5	223,2	156,7	-	-	
800	490,0	460,6	431,2	401,8	367,5	328,3	284,2	230,3	161,7	-	-	
900	520,0	488,8	457,6	426,4	390,0	348,4	301,6	244,4	171,6	-	-	
1000	545,0	512,3	479,6	446,9	408,7	365,1	316,1	256,1	179,8	-	-	
1250	590,0	554,6	519,2	483,8	442,5	395,3	342,2	277,3	194,7	-	-	
1500	625,0	587,5	550,0	512,5	468,7	418,7	362,5	293,7	206,2	-	-	
1750	650,0	611,0	572,0	533,0	487,5	435,5	377,0	305,5	214,5	-	-	
2000	665,0	625,1	585,2	545,3	498,7	445,5	385,7	312,5	219,4	-	-	

Tabella B.6I. Portata dei conduttori in canalina o in cavo con temperatura dell'isolamento 90°C secondo CSA C22.1 (CE Code) – Ed. 2015-2021 (Table 2)
 Table B.6I. Ampacities of conductors in raceway or cable with 90°C insulation temperature according to CSA C22.1 (CE Code) – Ed. 2015-2021 (Table 2)

Sezione del conduttore Conductor's size [AWG/kcmil]	Portata massima per conduttori in rame isolati [A], per tensioni non superiori a 5000V, in canalina o in cavo Temperatura dell'isolamento 90°C Allowable ampacities of insulated copper conductors [A], rated not more than 5000V, in raceway or cable Insulation temperature 90°C											
	Temperatura ambiente Ta Ambient temperature Ta											
	30°C	31÷35°C	36÷40°C	41÷45°C	46÷50°C	51÷55°C	56÷60°C	61÷65°C	66÷70°C	71÷75°C	76÷80°C	
14 AWG	25,0	24,0	22,7	21,7	20,5	19,0	17,7	16,2	14,5	12,5	10,2	
12	30,0	28,8	27,3	26,1	24,6	22,8	21,3	19,5	17,4	15,0	12,3	
10	40,0	38,4	36,4	34,8	32,8	30,4	28,4	26,0	23,2	20,0	16,4	
8	55,0	52,8	50,0	47,8	45,1	41,8	39,0	35,7	31,9	27,5	22,5	
6	75,0	72,0	68,2	65,2	61,5	57,0	53,2	48,7	43,5	37,5	30,7	
4	95,0	91,2	86,4	82,6	77,9	72,2	67,4	61,7	55,1	47,5	38,9	
3	115,0	110,4	104,6	100,0	94,3	87,4	81,6	74,7	66,7	57,5	47,1	
2	130,0	124,8	118,3	113,1	106,6	98,8	92,3	84,5	75,4	65,0	53,3	
1	145,0	139,2	131,9	126,1	118,9	110,2	102,9	94,2	84,1	72,5	59,4	
1/0	170,0	163,2	154,7	147,9	139,4	129,2	120,7	110,5	98,6	85,0	69,7	
2/0	195,0	187,2	177,4	169,6	159,9	148,2	138,4	126,7	113,1	97,5	79,9	
3/0	225,0	216,0	204,7	195,7	184,5	171,0	159,7	146,2	130,5	112,5	92,2	
4/0	260,0	249,6	236,6	226,2	213,2	197,6	184,6	169,0	150,8	130,0	106,6	
250 kcmil	290,0	278,4	263,9	252,3	237,8	220,4	205,9	188,5	168,2	145,0	118,9	
300	320,0	307,2	291,2	278,4	262,4	243,2	227,2	208,0	185,6	160,0	131,2	
350	350,0	336,0	318,5	304,5	287,0	266,0	248,5	227,5	203,0	175,0	143,5	
400	380,0	364,8	345,8	330,6	311,6	288,8	269,8	247,0	220,4	190,0	155,8	
500	430,0	412,8	391,3	374,1	352,6	326,8	305,3	279,5	249,4	215,0	176,3	
600	475,0	456,0	432,2	413,2	389,5	361,0	337,2	308,7	275,5	237,5	194,7	
700	520,0	499,2	473,2	452,4	426,4	395,2	369,2	338,0	301,6	260,0	213,2	
750	535,0	513,6	486,8	465,4	438,7	406,6	379,8	347,7	310,3	267,5	219,3	
800	555,0	532,8	505,0	482,8	455,1	421,8	394,0	360,7	321,9	277,5	227,5	
900	585,0	561,6	532,3	508,9	479,7	444,6	415,3	380,2	339,3	292,5	239,8	
1000	615,0	590,4	559,6	535,0	504,3	467,4	436,6	399,7	356,7	307,5	252,1	
1250	665,0	638,4	605,1	578,5	545,3	505,4	472,1	432,2	385,7	332,5	272,6	
1500	705,0	676,8	641,5	613,3	578,1	535,8	500,5	458,2	408,9	352,5	289,0	
1750	735,0	705,6	668,8	639,4	602,7	558,6	521,8	477,7	426,3	367,5	301,3	
2000	750,0	720,0	682,5	652,5	615,0	570,0	532,5	487,5	435,0	375,0	307,5	

Tabella B.6m. Portata dei conduttori in canalina o in cavo con temperatura dell'isolamento 110°C secondo CSA C22.1 (CE Code) – Ed. 2015-2021 (Table 2)
 Table B.6m. Ampacities of conductors in raceway or cable with 110°C insulation temperature according to CSA C22.1 (CE Code) – Ed. 2015-2021 (Table 2)

Sezione del conduttore Conductor's size [AWG/kcmil]	Portata massima per conduttori in rame isolati [A], per tensioni non superiori a 5000V, in canalina o in cavo, temperatura ambiente Ta, temperatura dell'isolamento 110°C Allowable ampacities of insulated copper conductors [A], rated not more than 5000V, in raceway or cable, Ambient temperature Ta, Insulation temperature 110°C																
	Temperatura ambiente Ta Ambient temperature Ta																
	30°C	31÷35°C	36÷40°C	41÷45°C	46÷50°C	51÷55°C	56÷60°C	61÷65°C	66÷70°C	71÷75°C	76÷80°C	81÷90°C	91÷100°C	101÷110°C	111÷120°C	121÷130°C	131÷140°C
14 AWG	25,0	24,2	23,5	22,5	21,7	20,7	19,7	18,7	17,7	16,5	15,2	12,5	8,7	-	-	-	-
12	30,0	29,1	28,2	27,0	26,1	24,9	23,7	22,5	21,3	19,8	18,3	15,0	10,5	-	-	-	-
10	45,0	43,6	42,3	40,5	39,1	37,3	35,5	33,7	31,9	29,7	27,4	22,5	15,7	-	-	-	-
8	65,0	63,0	61,1	58,5	56,5	53,9	51,3	48,7	46,1	42,9	39,6	32,5	22,7	-	-	-	-
6	80,0	77,6	75,2	72,0	69,6	66,4	63,2	60,0	56,8	52,8	48,8	40,0	28,0	-	-	-	-
4	105,0	101,8	98,7	94,5	91,3	87,1	82,9	78,7	74,5	69,3	64,0	52,5	36,7	-	-	-	-
3	125,0	121,2	117,5	112,5	108,7	103,7	98,7	93,7	88,7	82,5	76,2	62,5	43,7	-	-	-	-
2	145,0	140,6	136,3	130,5	126,1	120,3	114,5	108,7	102,9	95,7	88,4	72,5	50,7	-	-	-	-
1	165,0	160,0	155,1	148,5	143,5	136,9	130,3	123,7	117,1	108,9	100,6	82,5	57,7	-	-	-	-
1/0	190,0	184,3	178,6	171,0	165,3	157,7	150,1	142,5	134,9	125,4	115,9	95,0	66,5	-	-	-	-
2/0	220,0	213,4	206,8	198,0	191,4	182,6	173,8	165,0	156,2	145,2	134,2	110,0	77,0	-	-	-	-
3/0	255,0	247,3	239,7	229,5	221,8	211,6	201,4	191,2	181,0	168,3	155,5	127,5	89,2	-	-	-	-
4/0	290,0	281,3	272,6	261,0	252,3	240,7	229,1	217,5	205,9	191,4	176,9	145,0	101,5	-	-	-	-
250 kcmil	320,0	310,4	300,8	288,0	278,4	265,6	252,8	240,0	227,2	211,2	195,2	160,0	112,0	-	-	-	-
300	360,0	349,2	338,4	324,0	313,2	298,8	284,4	270,0	255,6	237,6	219,6	180,0	126,0	-	-	-	-
350	390,0	378,3	366,6	351,0	339,3	323,7	308,1	292,5	276,9	257,4	237,9	195,0	136,5	-	-	-	-
400	425,0	412,2	399,5	382,5	369,7	352,7	335,7	318,7	301,7	280,5	259,2	212,5	148,7	-	-	-	-
500	480,0	465,6	451,2	432,0	417,6	398,4	379,2	360,0	340,8	316,8	292,8	240,0	168,0	-	-	-	-
600	530,0	514,1	498,2	477,0	461,1	439,9	418,7	397,5	376,3	349,8	323,3	265,0	185,5	-	-	-	-
700	580,0	562,6	545,2	522,0	504,6	481,4	458,2	435,0	411,8	382,8	353,8	290,0	203,0	-	-	-	-
750	600,0	582,0	564,0	540,0	522,0	498,0	474,0	450,0	426,0	396,0	366,0	300,0	210,0	-	-	-	-
800	620,0	601,4	582,8	558,0	539,4	514,6	489,8	465,0	440,2	409,2	378,2	310,0	217,0	-	-	-	-
900	655,0	635,3	615,7	589,5	569,8	543,6	517,4	491,2	465,0	432,3	399,5	327,5	229,2	-	-	-	-
1000	690,0	669,3	648,6	621,0	600,3	572,7	545,1	517,5	489,9	455,4	420,9	345,0	241,5	-	-	-	-
1250	745,0	722,6	700,3	670,5	648,1	618,3	588,5	558,7	528,9	491,7	454,4	372,5	260,7	-	-	-	-
1500	790,0	766,3	742,6	711,0	687,3	655,7	624,1	592,5	560,9	521,4	481,9	395,0	276,5	-	-	-	-
1750	820,0	795,4	770,8	738,0	713,4	680,6	647,8	615,0	582,2	541,2	500,2	410,0	287,0	-	-	-	-
2000	840,0	814,8	789,6	756,0	730,8	697,2	663,6	630,0	596,4	554,4	512,4	420,0	294,0	-	-	-	-

Tabella B.6n. Portata dei conduttori in canalina o in cavo con temperatura dell'isolamento 125°C secondo CSA C22.1 (CE Code) – Ed. 2015-2021 (Table 2)
 Table B.6n. Ampacities of conductors in raceway or cable with 125°C insulation temperature according to CSA C22.1 (CE Code) – Ed. 2015-2021 (Table 2)

Sezione del conduttore Conductor's size [AWG/kcmil]	Portata massima per conduttori in rame isolati [A], per tensioni non superiori a 5000V, in canalina o in cavo, temperatura ambiente Ta, temperatura dell'isolamento 125°C Allowable ampacities of insulated copper conductors [A], rated not more than 5000V, in raceway or cable, Ambient temperature Ta, Insulation temperature 125°C																
	Temperatura ambiente Ta Ambient temperature Ta																
	30°C	31÷35°C	36÷40°C	41÷45°C	46÷50°C	51÷55°C	56÷60°C	61÷65°C	66÷70°C	71÷75°C	76÷80°C	81÷90°C	91÷100°C	101÷110°C	111÷120°C	121÷130°C	131÷140°C
14 AWG	30,0	29,1	28,5	27,6	26,7	25,8	24,9	23,7	22,8	21,9	20,7	18,3	15,3	12,0	6,9		
12	35,0	33,9	33,2	32,2	31,1	30,1	29,0	27,6	26,6	25,5	24,1	21,3	17,8	14,0	8,0		
10	45,0	43,6	42,7	41,4	40,0	38,7	37,3	35,5	34,2	32,8	31,0	27,4	22,9	18,0	10,3		
8	65,0	63,0	61,7	59,8	57,8	55,9	53,9	51,3	49,4	47,4	44,8	39,6	33,1	26,0	14,9		
6	90,0	87,3	85,5	82,8	80,1	77,4	74,7	71,1	68,4	65,7	62,1	54,9	45,9	36,0	20,7		
4	115,0	111,5	109,2	105,8	102,3	98,9	95,4	90,8	87,4	83,9	79,3	70,1	58,6	46,0	26,4		
3	135,0	130,9	128,2	124,2	120,1	116,1	112,0	106,6	102,6	98,5	93,1	82,3	68,8	54,0	31,0		
2	155,0	150,3	147,2	142,6	137,9	133,3	128,6	122,4	117,8	113,1	106,9	94,5	79,0	62,0	35,6		
1	175,0	169,7	166,2	161,0	155,7	150,5	145,2	138,2	133,0	127,7	120,7	106,7	89,2	70,0	40,2		
1/0	200,0	194,0	190,0	184,0	178,0	172,0	166,0	158,0	152,0	146,0	138,0	122,0	102,0	80,0	46,0		
2/0	235,0	227,9	223,2	216,2	209,1	202,1	195,0	185,6	178,6	171,5	162,1	143,3	119,8	94,0	54,0		
3/0	270,0	261,9	256,5	248,4	240,3	232,2	224,1	213,3	205,2	197,1	186,3	164,7	137,7	108,0	62,1		
4/0	310,0	300,7	294,5	285,2	275,9	266,6	257,3	244,9	235,6	226,3	213,9	189,1	158,1	124,0	71,3		
250 kcmil	345,0	334,6	327,7	317,4	307,0	296,7	286,3	272,5	262,2	251,8	238,0	210,4	175,9	138,0	79,3		
300	385,0	373,4	365,7	354,2	342,6	331,1	319,5	304,1	292,6	281,0	265,6	234,8	196,3	154,0	88,5		
350	420,0	407,4	399,0	386,4	373,8	361,2	348,6	331,8	319,2	306,6	289,8	256,2	214,2	168,0	96,6		
400	450,0	436,5	427,5	414,0	400,5	387,0	373,5	355,5	342,0	328,5	310,5	274,5	229,5	180,0	103,5		
500	510,0	494,7	484,5	469,2	453,9	438,6	423,3	402,9	387,6	372,3	351,9	311,1	260,1	204,0	117,3		
600	565,0	548,0	536,7	519,8	502,8	485,9	468,9	446,3	429,4	412,4	389,8	344,6	288,1	226,0	129,9		
700	620,0	601,4	589,0	570,4	551,8	533,2	514,6	489,8	471,2	452,6	427,8	378,2	316,2	248,0	142,6		
750	640,0	620,8	608,0	588,8	569,6	550,4	531,2	505,6	486,4	467,2	441,6	390,4	326,4	256,0	147,2		
800	660,0	640,2	627,0	607,2	587,4	567,6	547,8	521,4	501,6	481,8	455,4	402,6	336,6	264,0	151,8		
900	700,0	679,0	665,0	644,0	623,0	602,0	581,0	553,0	532,0	511,0	483,0	427,0	357,0	280,0	161,0		
1000	735,0	712,9	698,2	676,2	654,1	632,1	610,0	580,6	558,6	536,5	507,1	448,3	374,8	294,0	169,0		

Tabella B.6o. Portata dei conduttori in canalina o in cavo con temperatura dell'isolamento 200°C secondo CSA C22.1 (CE Code) – Ed. 2015-2021 (Table 2)
 Table B.6o. Ampacities of conductors in raceway or cable with 200°C insulation temperature according to CSA C22.1 (CE Code) – Ed. 2015-2021 (Table 2)

Sezione del conduttore Conductor's size [AWG/kcmil]	Portata massima per conduttori in rame isolati [A], per tensioni non superiori a 5000V, in canalina o in cavo, temperatura ambiente Ta, temperatura dell'isolamento 200°C Allowable ampacities of insulated copper conductors [A], rated not more than 5000V, in raceway or cable, Ambient temperature Ta, Insulation temperature 200°C																
	Temperatura ambiente Ta Ambient temperature Ta																
	30°C	31÷35°C	36÷40°C	41÷45°C	46÷50°C	51÷55°C	56÷60°C	61÷65°C	66÷70°C	71÷75°C	76÷80°C	81÷90°C	91÷100°C	101÷110°C	111÷120°C	121÷130°C	131÷140°C
14 AWG	35,0	34,6	33,9	33,2	32,9	32,2	31,8	31,1	30,4	30,1	29,4	28,0	26,9	25,5	24,1	22,4	20,6
12	40,0	39,6	38,8	38,0	37,6	36,8	36,4	35,6	34,8	34,4	33,6	32,0	30,8	29,2	27,6	25,6	23,6
10	60,0	59,4	58,2	57,0	56,4	55,2	54,6	53,4	52,2	51,6	50,4	48,0	46,2	43,8	41,4	38,4	35,4
8	80,0	79,2	77,6	76,0	75,2	73,6	72,8	71,2	69,6	68,8	67,2	64,0	61,6	58,4	55,2	51,2	47,2
6	110,0	109,9	106,7	104,5	103,4	101,2	100,1	97,9	95,7	94,6	92,4	88,0	84,7	80,3	75,9	70,4	64,9
4	140,0	138,6	135,8	133,0	131,6	128,8	127,4	124,6	121,8	120,4	117,6	112,0	107,8	102,2	96,6	89,6	82,6
3	165,0	163,3	160,0	156,7	155,1	151,8	150,1	146,8	143,5	141,9	138,6	132,0	127,0	120,4	113,8	105,6	97,3
2	190,0	188,1	184,3	180,5	178,6	174,8	172,9	169,1	165,3	163,4	159,6	152,0	146,3	138,7	131,1	121,6	112,1
1	215,0	212,8	208,5	204,2	202,1	197,8	195,6	191,3	187,0	184,9	180,6	172,0	165,5	156,9	148,3	137,6	126,8
1/0	245,0	242,5	237,6	232,7	230,3	225,4	222,9	218,0	213,1	210,7	205,8	196,0	188,6	178,8	169,0	156,8	144,5
2/0	290,0	287,1	281,3	275,5	272,6	266,8	263,9	258,1	252,3	249,4	243,6	232,0	223,3	211,7	200,1	185,6	171,1
3/0	330,0	326,7	320,1	313,5	310,2	303,6	300,3	293,7	287,1	283,8	277,2	264,0	254,1	240,9	227,7	211,2	194,7
4/0	380,0	376,2	368,6	361,0	357,2	349,6	345,8	338,2	330,6	326,8	319,2	304,0	292,6	277,4	262,2	243,2	224,2
250 kcmil	-	-	-	-	-	-	-	-	-	-	-	-	-	-	-	-	-
300	-	-	-	-	-	-	-	-	-	-	-	-	-	-	-	-	-
350	-	-	-	-	-	-	-	-	-	-	-	-	-	-	-	-	-
400	-	-	-	-	-	-	-	-	-	-	-	-	-	-	-	-	-
500	-	-	-	-	-	-	-	-	-	-	-	-	-	-	-	-	-
600	-	-	-	-	-	-	-	-	-	-	-	-	-	-	-	-	-
700	-	-	-	-	-	-	-	-	-	-	-	-	-	-	-	-	-
750	-	-	-	-	-	-	-	-	-	-	-	-	-	-	-	-	-
800	-	-	-	-	-	-	-	-	-	-	-	-	-	-	-	-	-
900	-	-	-	-	-	-	-	-	-	-	-	-	-	-	-	-	-
1000	-	-	-	-	-	-	-	-	-	-	-	-	-	-	-	-	-
1250	-	-	-	-	-	-	-	-	-	-	-	-	-	-	-	-	-
1500	-	-	-	-	-	-	-	-	-	-	-	-	-	-	-	-	-
1750	-	-	-	-	-	-	-	-	-	-	-	-	-	-	-	-	-
2000	-	-	-	-	-	-	-	-	-	-	-	-	-	-	-	-	-

Tabella B.6p. Fattori di correzione delle portate indicate nelle tabelle precedenti in funzione del numero di conduttori in canalina o in cavo secondo CSA C22.1 (CE Code) – Ed. 2015-2021 (Table 5C)
Table B.6p. Adjustment factors of ampacities indicated in the previous tables based on the number of c conductors in raceway or cable according CSA C22.1 (CE Code)– Ed. 2015-2021 (Table 5C)

Numero di conduttori <i>Number of conductors</i>	Coefficiente di correzione <i>Correction factor</i>
1÷3	1,00
4÷6	0,80
7÷24	0,70
25÷42	0,60
>42	0,50

B.7 Portate dei conduttori secondo EN 60204-1 Current-carrying capacity of conductors according to EN 60204-1

Le tabelle mostrano le portate dei conduttori pubblicate nella norma alla quale si deve fare sempre riferimento.
The tables show the ampacities of the conductors published in the standard to which reference must always be made.

Tabella B.7a. Portate dei conduttori secondo IEC 60204-1:2016. Conduttori o cavi unipolari in tubi o in canaline.
Table B.7a. Current-carrying capacity of conductors according to IEC 60204-1:2016.- Conductors or single core cables in conduits.

Sezione del conduttore Size [mm ²]	Portata massima [A] per conduttori o cavi unipolari in rame isolati in PVC Current-carrying capacity [A] for PVC insulated copper conductors or single core cables				
	Installazione in tubi protettivi o in canaline Installation in conduits or in cable trays				
	Temperatura ambiente Ta Ambient temperature Ta				
	40°C	45°C	50°C	55°C	60°C
0,2 ^(a)	4,5	4,1	3,7	3,2	2,6
0,5 ^(a)	7,9	7,2	6,5	5,6	4,6
0,75 ^(a)	9,5	8,6	7,8	6,7	5,5
0,75 ^(b)	8,6	7,8	7,1	6,1	5,0
1 ^(b)	10,3	9,4	8,4	7,3	6,0
1,5 ^(b)	13,5	12,3	11,1	9,6	7,8
2,5 ^(b)	18,3	16,7	15,0	13,0	10,6
4 ^(b)	24,0	21,8	19,7	17,0	13,9
6 ^(b)	31,0	28,2	25,4	22,0	18,0
10 ^(b)	44,0	40,0	36,1	31,2	25,5
16 ^(b)	59,0	53,7	48,4	41,9	34,2
25 ^(b)	77,0	70,1	63,1	54,7	44,7
35 ^(b)	96,0	87,4	78,7	68,2	55,7
50 ^(b)	117,0	106,5	95,9	83,1	67,9
70 ^(b)	149,0	135,6	122,2	105,8	86,4
95 ^(b)	180,0	163,8	147,6	127,8	104,4
120 ^(b)	208,0	189,3	170,6	147,7	120,6

^(a) I valori di portata sono basati su una coppia di circuiti di comando per sezioni comprese tra 0,2 mm² e 0,75 mm².

^(b) I valori di portata sono basati su un circuito trifase simmetrico per sezioni di 0,75 mm² e superiori.

^(a) The values of the current-carrying capacity are based on one control circuit pair for size between 0,2 mm² and 0,75 mm².

^(b) The values of the current-carrying capacity are based one symmetrical three-phase circuit for size 0,75 mm² and greater.

Tabella B.7b. Portate dei conduttori secondo IEC 60204-1:2016. Cavi multipolari in tubi o in canaline.

Table B.7b. Current-carrying capacity of conductors according to IEC 60204-1:2016. Multicore cables in conduits.

Sezione del conduttore Size [mm ²]	Portata massima [A], per cavi multipolari in rame isolati in PVC Current-carrying capacity [A] for PVC insulated copper cables				
	Installazione in tubi protettivi o in canaline Installation in conduits or in cable trays				
	Temperatura ambiente Ta Ambient temperature Ta				
	40°C	45°C	50°C	55°C	60°C
0,2 ^(a)	4,3	3,9	3,5	3,1	2,5
0,5 ^(a)	7,5	6,8	6,2	5,3	4,4
0,75 ^(a)	9	8,2	7,4	6,4	5,2
0,75 ^(b)	8,5	7,7	7,0	6,0	4,9
1 ^(b)	10,1	9,2	8,3	7,2	5,9
1,5 ^(b)	13,1	11,9	10,7	9,3	7,6
2,5 ^(b)	17,4	15,8	14,3	12,4	10,1
4 ^(b)	23,0	20,9	18,9	16,3	13,3
6 ^(b)	30,0	27,3	24,6	21,3	17,4
10 ^(b)	40,0	36,4	32,8	28,4	23,2
16 ^(b)	54,0	49,1	44,3	38,3	31,3
25 ^(b)	70,0	63,7	57,4	49,7	40,6
35 ^(b)	86,0	78,3	70,5	61,1	49,9
50 ^(b)	103,0	93,7	84,5	73,1	59,7
70 ^(b)	130,0	118,3	106,6	92,3	75,4
95 ^(b)	156,0	142,0	127,9	110,8	90,5
120 ^(b)	179,0	162,9	146,8	127,1	103,8

^(a) I valori di portata sono basati su una coppia di circuiti di comando per sezioni comprese tra 0,2 mm² e 0,75 mm².

^(b) I valori di portata sono basati su un circuito trifase simmetrico per sezioni di 0,75 mm² e superiori.

^(a) The values of the current-carrying capacity are based on one control circuit pari for size between 0,2 mm² and 0,75 mm².

^(b) The values of the current-carrying capacity are based one symmetrical three-phase circuit for size 0,75 mm² and greater.

Tabella B.7c. Portate dei conduttori secondo IEC 60204-1:2016. Cavi multipolari in aria libera, orizzontali o verticali, senza spazi tra i cavi sulle pareti.

Table B.7c. Current-carrying capacity of conductors according to IEC 60204-1:2016. Multicore cables installed in free air, horizontal or vertical without gap between cables on walls.

Sezione del conduttore Size [mm ²]	Portata massima [A] per cavi multipolari in rame isolati in PVC Current-carrying capacity [A] for PVC insulated copper cables				
	Installazione in aria libera, orizzontali o verticali, senza spazi tra i cavi sulle pareti Installation in free air, horizontal or vertical without gap between cables on walls				
	Temperatura ambiente Ta Ambient temperature Ta				
	40°C	45°C	50°C	55°C	60°C
0,2 ^(a)	4,4	4,0	3,6	3,1	2,6
0,5 ^(a)	7,5	6,8	6,2	5,3	4,4
0,75 ^(a)	9,5	8,6	7,8	6,7	5,5
0,75 ^(b)	9,8	8,9	8,0	7,0	5,7
1 ^(b)	11,7	10,6	9,6	8,3	6,8
1,5 ^(b)	15,2	13,8	12,5	10,8	8,8
2,5 ^(b)	21,0	19,1	17,2	14,9	12,2
4 ^(b)	28,0	25,5	23,0	19,9	16,2
6 ^(b)	36,0	32,8	29,5	25,6	20,9
10 ^(b)	50,0	45,5	41,0	35,5	29,0
16 ^(b)	66,0	60,1	54,1	46,9	38,3
25 ^(b)	84,0	76,4	68,9	59,6	48,7
35 ^(b)	104,0	94,6	85,3	73,8	60,3
50 ^(b)	125,0	113,8	102,5	88,8	72,5
70 ^(b)	160,0	145,6	131,2	113,6	92,8
95 ^(b)	194,0	176,5	159,1	137,7	112,5
120 ^(b)	225,0	204,8	184,5	159,8	130,5

(a) I valori di portata sono basati su una coppia di circuiti di comando per sezioni comprese tra 0,2 mm² e 0,75 mm².

(b) I valori di portata sono basati su un circuito trifase simmetrico per sezioni di 0,75 mm² e superiori.

(a) The values of the current-carrying capacity are based on one control circuit pair for size between 0,2 mm² and 0,75 mm².

(b) The values of the current-carrying capacity are based one symmetrical three-phase circuit for size 0,75 mm² and greater.

Tabella B.7d. Portate dei conduttori secondo IEC 60204-1:2016. Cavi multipolari in aria libera, orizzontali o verticali, su passerelle aperte.

Table B.7d. Current-carrying capacity of conductors according to IEC 60204-1:2016. Multicore cables installed in free air, horizontal or vertical laid on open cable trays.

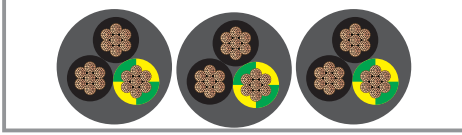
Sezione del conduttore Size [mm ²]	Portata massima [A] per cavi multipolari in rame isolati in PVC Current-carrying capacity [A] for PVC insulated copper cables				
	Installazione in aria libera, orizzontali o verticali, su passerelle aperte Installation in free air, horizontal or vertical laid on open trays				
					
	Temperatura ambiente Ta Ambient temperature Ta				
	40°C	45°C	50°C	55°C	60°C
0,2 ^(a)	4,4	4,0	3,6	3,1	2,6
0,5 ^(a)	7,8	7,1	6,4	5,5	4,5
0,75 ^(a)	10	9,1	8,2	7,1	5,8
0,75 ^(b)	10,4	9,5	8,5	7,4	6,0
1 ^(b)	12,4	11,3	10,2	8,8	7,2
1,5 ^(b)	16,1	14,7	13,2	11,4	9,3
2,5 ^(b)	22,0	20,0	18,0	15,6	12,8
4 ^(b)	30,0	27,3	24,6	21,3	17,4
6 ^(b)	37,0	33,7	30,3	26,3	21,5
10 ^(b)	52,0	47,3	42,6	36,9	30,2
16 ^(b)	70,0	63,7	57,4	49,7	40,6
25 ^(b)	88,0	80,1	72,2	62,5	51,0
35 ^(b)	110,0	100,1	90,2	78,1	63,8
50 ^(b)	133,0	121,0	109,1	94,4	77,1
70 ^(b)	171,0	155,6	140,2	121,4	99,2
95 ^(b)	207,0	188,4	169,7	147,0	120,1
120 ^(b)	240,0	218,4	196,8	170,4	139,2

(a) I valori di portata sono basati su una coppia di circuiti di comando per sezioni comprese tra 0,2 mm² e 0,75 mm².

(b) I valori di portata sono basati su un circuito trifase simmetrico per sezioni di 0,75 mm² e superiori.

(a) The values of the current-carrying capacity are based on one control circuit pari for size between 0,2 mm² and 0,75 mm².

(b) The values of the current-carrying capacity are based one symmetrical three-phase circuit for size 0,75 mm² and greater.

Tabella B.7e. Coefficienti di declassamento delle portate in funzione del numero di conduttori o coppie di conduttori alimentate all'interno del cavo multipolare secondo EN 60204-1:2016.

Table B.7e. Derating factors based on the number loaded conductors or pairs in multicore cables according to EN 60204-1:2016.

Numero di conduttori o di coppie alimentate Number of loaded conductors or pairs	Conduttori con sezione superiore a 1 mm ² Conductors' sizes > 1 mm ²	Coppie di conduttori con sezione da 0,25 mm ² a 0,75 mm ² Pairs' sizes 0,25 mm ² to 0,75 mm ²
1	-	1,0
3	1,0	-
5	0,75	0,39
7	0,65	0,34
10	0,55	0,29
24	0,40	0,21

Tabella B.7f. Coefficienti di declassamento delle portate in funzione del raggruppamento di cavi alimentati secondo IEC 60204-1:2016.

Table B.7f. Derating factors for cables grouping according to IEC 60204-1:2016.

Tipo di installazione <i>Method of installation</i>	Numero di cavi o circuiti alimentati <i>Number of loaded circuits/cables</i>			
	2	4	6	9
Coppie di circuiti di comando con sezione inferiore o uguale a 0,5 mm ² indipendentemente dal tipo di installazione. <i>Control circuit pairs < 0,5 mm² independent of methods of installation</i>	0,76	0,57	0,48	0,40
Conduttori, cavi unipolari o cavi multipolari in tubi protettivi o in canalina. <i>Conductors, single core cables or multicore cables in conduits.</i>	0,80	0,65	0,57	0,50
Cavi multipolari installati in aria libera, orizzontali o verticali, senza spazi tra i cavi sulle pareti (singolo strato). <i>Multicore cables installed in free air, horizontal or vertical without gap between cables and walls (single layer).</i>	0,85	0,75	0,72	0,70
Cavi multipolari installati in aria libera, orizzontali o verticali, passerella perforata ^(a) senza spazio tra i cavi (singolo strato). <i>Multicore cables installed in free air, horizontal or vertical on one perforated tray^(a) without gap between cables (single layer).</i>	0,88	0,77	0,73	0,72
Cavi multipolari installati in aria libera, orizzontali o verticali, passerella perforata ^(a) senza spazio tra i cavi (2 o 3 passerelle, con una distanza verticale di 300 mm tra ogni passerella). <i>Multicore cables installed in free air, horizontal or vertical on one perforated tray^(a) without gap between cables (2 or 3 trays, with a vertical spacing between each tray of 300 mm).</i>	0,86	0,76	0,71	0,66

^(a) Una passerella perforata è una passerella nella quale i fori occupano più del 30% dell'area della base.

Nota 1. Tali fattori si applicano a cavi, tutti ugualmente alimentati, con il circuito stesso caricato simmetricamente o a gruppi di circuiti di conduttori o cavi isolati con la stessa temperatura massima di funzionamento ammissibile.

Nota 2. Gli stessi fattori si applicano a gruppi di due o tre cavi unipolari e a cavi multipolari.

^(a) A perforated cable tray is a tray where the holes occupy more than 30 % of the area of the base.



Nota 1. These factors are applicable to cables, all equally loaded, the circuit itself symmetrically loaded or to groups of circuits of insulated conductors or cables having the same allowable maximum operating Temperature range.

Nota 2. The same factors are applied to groups of two or three single core or multicore cables.

B.8 Portate dei conduttori secondo VDE 0298-4 Ampacities of conductors according to VDE 0298-4

Le tabelle mostrano le portate dei conduttori pubblicate nella norma alla quale si deve fare sempre riferimento.
The tables show the ampacities of the conductors published in the standard to which reference must always be made.

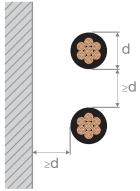
Tabella B.8a. Portate dei conduttori con tensioni fino a 1000V secondo VDE 0298-4 – Ed. 2013 - Tabelle 11
Table B.8a. Ampacities of conductors with rated voltage up to 1000V according to VDE 0298-4 – Ed. 2013 - Tabelle 11

Sezione del conduttore Conductor's size [mm ²]	Tipologia di cavo e metodo di installazione Cable's type and method of installation					
	Cavi unipolari (isolati in gomma, PVC o TPE; resistenti al calore ⁽³⁾), posati in aria libera Single core cables (rubber, PVC, TPE insulated; heat resistant ⁽³⁾) free in air		Cavi multipolari (isolati in gomma, PVC o TPE) per apparati domestici e portatili, posati su superfici Multicore cables (rubber, PVC, TPE insulated) for home- and portable apparatus, on surfaces		Cavi multipolari (isolati in gomma, PVC o TPE; resistenti al calore ⁽³⁾) esclusi quelli per apparati domestici e portatili, posati su superfici Multicore cables (rubber, PVC, TPE insulated; heat resistant ⁽³⁾) excluded for home- and portable apparatus, on surfaces	
						
	Numero di conduttori alimentati Number of current carrying conductors					
	1	2	3	2	3	
	Portata massima [A] Allowable ampacity [A]					
0,08 ⁽¹⁾	1,5	-	-	1	1	
0,14 ⁽¹⁾	3	-	-	2	2	
0,25 ⁽¹⁾	5	-	-	4	4	
0,34 ⁽¹⁾	8	-	-	6	6	
0,5	12 ⁽²⁾	3	3	9 ⁽²⁾	9 ⁽²⁾	
0,75	15	6	6	12	12	
1	19	10	10	15	15	
1,5	24	16	16	18	18	
2,5	32	25	20	26	26	
4	42	32	25	34	34	
6	54	40	-	44	44	
10	73	63	-	61	61	
16	98	-	-	82	82	
25	129	-	-	108	108	
35	158	-	-	135	135	
50	198	-	-	168	168	
70	245	-	-	207	207	
95	292	-	-	250	250	
120	344	-	-	292	292	
150	391	-	-	335	335	
185	448	-	-	382	382	
240	528	-	-	453	453	
300	608	-	-	523	523	
400	726	-	-	-	-	
500	830	-	-	-	-	
Fattore Factor	Tabella di riferimento per i fattori di declassamento da applicare ai valori di portata sopra indicati Reference table for the correction factors for the ampacities indicated above					
Temperatura ambiente Ambient temperature	Tabella B.8b Table B.8b	Tabella B.8b Table B.8b	Tabella B.8b Table B.8b	Tabella B.8b Table B.8b	Tabella B.8b Table B.8b	
Circuiti di cavi unipolari Circuits of single-core cables	Tabella B.8c Table B.8c	-	-	-	-	
Circuiti di cavi multipolari Circuits of multi-cores cables	-	Tabella B.8d Table B.8d	Tabella B.8d Table B.8d	Tabella B.8d Table B.8d	Tabella B.8d Table B.8d	

Fattore Factor	Tabella di riferimento per i fattori di declassamento da applicare ai valori di portata sopra indicati Reference table for the correction factors for the ampacities indicated above				
Cavi avvolti in matasse, bobine o a spirale Cables wound in spool, reel, drum or helix-type coiled	Tabella B.8e Table B.8e	Tabella B.8e Table B.8e	Tabella B.8e Table B.8e	Tabella B.8e Table B.8e	Tabella B.8e Table B.8e
Posa su superfici, in tubo o in condotti Installation on surfaces, in raceways or conduits	Tabella B.8f Table B.8f	Tabella B.8f Table B.8f	Tabella B.8f Table B.8f	Tabella B.8f Table B.8f	Tabella B.8f Table B.8f
Posa in canaline Installation in cable trays	Tabella B.8g Table B.8g	Tabella B.8h Table B.8h	Tabella B.8h Table B.8h	Tabella B.8h Table B.8h	Tabella B.8h Table B.8h

(1) In accordo alla VDE 0891-1, valori non inclusi nella VDE 0298-4.

According to VDE 0891-1, values not included in VDE 0298-4.

(2) In accordo alla VDE 0100-523, valori non inclusi nella VDE 0298-4.

According to VDE 0100-523, values not included in VDE 0298-4.

(3) I cavi resistenti al calore hanno in genere una temperatura di isolamento di almeno 90°C (maggiori dettagli sono contenuti nella VDE 0298-4).

Heat resistant cables are typically with at least 90°C insulation temperature (see VDE 0298-4 for more details).

Tabella B.8b. Fattori di correzione delle portate indicate nella tabella B.8a in funzione della temperatura ambiente e della temperatura dell'isolamento dei cavi secondo VDE 0298-4

Ed. 2013 - Tabelle 17-18

Table B.8b. Correction factors for the ampacities indicated in the table B.8a for different ambient temperatures and different insulation temperatures of cables according to VDE 0298-4

Ed. 2013 - Tabelle 17-18

Temperatura ambiente Ta Ambient temperature Ta	Temperatura dell'isolamento Insulation temperature						
	60°C	70°C	80°C	90°C ⁽¹⁾	110°C ⁽¹⁾	135°C ⁽¹⁾	180°C ⁽¹⁾
Fattore di correzione Correction factor							
30	1,00	1,00	1,00	1,00	1,00	1,00	1,00
35	0,91	0,94	0,95	1,00	1,00	1,00	1,00
40	0,82	0,87	0,89	1,00	1,00	1,00	1,00
45	0,71	0,79	0,84	1,00	1,00	1,00	1,00
50	0,58	0,71	0,77	1,00	1,00	1,00	1,00
55	0,41	0,61	0,71	0,94	1,00	1,00	1,00
60	-	0,50	0,63	0,87	1,00	1,00	1,00
65	-	0,35	0,55	0,79	1,00	1,00	1,00
70	-	-	0,45	0,71	1,00	1,00	1,00
75	-	-	0,32	0,61	1,00	1,00	1,00
80	-	-	-	0,50	1,00	1,00	1,00
85	-	-	-	0,35	0,91	1,00	1,00
90	-	-	-	-	0,82	1,00	1,00
95	-	-	-	-	0,71	1,00	1,00
100	-	-	-	-	0,58	0,94	1,00
105	-	-	-	-	0,41	0,87	1,00
110	-	-	-	-	-	0,79	1,00
115	-	-	-	-	-	0,71	1,00
120	-	-	-	-	-	0,61	1,00
125	-	-	-	-	-	0,50	1,00
130	-	-	-	-	-	0,35	1,00
135	-	-	-	-	-	-	1,00
140	-	-	-	-	-	-	1,00
145	-	-	-	-	-	-	1,00
150	-	-	-	-	-	-	1,00
155	-	-	-	-	-	-	0,91
160	-	-	-	-	-	-	0,82
165	-	-	-	-	-	-	0,71
170	-	-	-	-	-	-	0,58
175	-	-	-	-	-	-	0,41

(1) Cavi resistenti al calore (maggiori dettagli sono contenuti nella VDE 0298-4).

Heat resistant cables (see VDE 0298-4 for more details).

Tabella B.8c. Fattori di correzione per circuiti di cavi unipolari secondo VDE 0298-4 – Ed. 2013 - Tabelle 10 – Nota a
Table B.8c. Correction factors for single-core cables' circuits according to VDE 0298-4 – Ed. 2013 - Tabelle 10 – Note a

Temperatura ambiente T_a Ambient temperature T_a	Tipo di installazione dei cavi unipolari Type of installation for single core cables	
	Gruppi di cavi unipolari in contatto tra loro o raggruppati posati su superfici Clusters of single core cables in touch to each other or bundled installed on surfaces	Gruppi di cavi unipolari in contatto tra loro o raggruppati posati in aria libera o in canaline Clusters of single core cables in touch to each other or bundled installed free in air or in cable trays
	Fattore di correzione Correction factor	
Circuiti monofase A.C. o circuiti C.C. A.C. single-phase circuits or D.C. circuits	0,76	0,80
Circuiti trifase A.C. A.C. three-phase circuits	0,67	0,70

Attenzione: per cavi unipolari installati in condotti o tubazioni, vedere la regola della tabella 10 della norma VDE 0298-4.
 Attention: for single core cables installed in conduits or in ducts please see rule of Table 10 of VDE 0298-4 standard.

Tabella B.8d. Fattori di correzione per circuiti di cavi multipolari con sezioni fino a 10 mm² secondo VDE 0298-4 – Ed. 2013 - Tabelle 26
Table B.8d. Correction factors for multi core cables' circuits up to 10 mm² size according to VDE 0298-4 – Ed. 2013 - Tabelle 26

Numero di conduttori in tensione Number of current carrying conductors	Fattore di correzione per cavi posati in aria libera Correction factor for cables in free air	Fattore di correzione per cavi posati interrati Correction factor for cables in earth (burial)
5	0,75	0,70
7	0,65	0,60
10	0,55	0,50
14	0,50	0,45
19	0,45	0,40
24	0,40	0,35
40	0,35	0,30
61	0,30	0,25

Tabella B.8e. Fattori di correzione per cavi avvolti in matasse, bobine o a spirale secondo VDE 0298-4 – Ed. 2013 - Tabelle 27
Table B.8e. Correction factors for cables winded in spool, reel, drum or helix-type coiled according to VDE 0298-4 – Ed. 2013 - Tabelle 27

Numero di strati su matassa o bobina Number of layers on spool, reel or drum	1	2	3	4	5
Fattore di correzione Correction factor	0,80 ⁽¹⁾	0,61	0,49	0,42	0,38

(1) Utilizzare questo fattore di correzione per cavi spirali su uno strato.
 Use this correction factor for spiral cables (in one layer).

Tabella B.8f. Fattori di correzione per circuiti di cavi unipolari e multipolari installati su pareti, pavimenti, soffitti o in tubi secondo VDE 0298-4 – Ed. 2013 - Tabelle 21
 Table B.8f. Correction factors for single-core and multicore cables' circuits on surfaces, walls, ceiling or in conduits according to VDE 0298-4 – Ed. 2013 - Tabelle 21

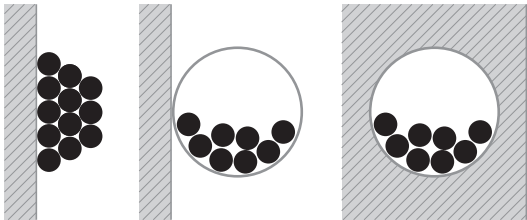
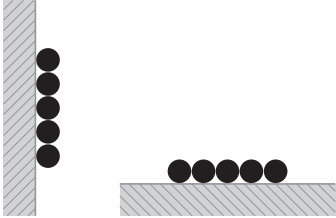
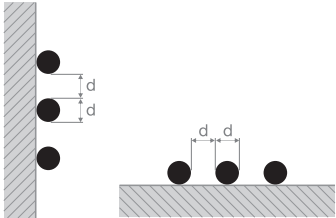
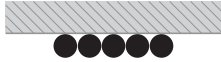
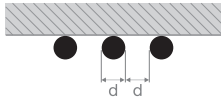
Metodo di installazione Installation method	Numero di cavi multipolari o numero di circuiti in A.C. o trifase costituiti da cavi unipolari (2 o 3 conduttori alimentati) Number of multi-core cables or number of A.C. or three-phase circuits of single-core cables (2 or 3 current-carrying conductors)														
	1	2	3	4	5	6	7	8	9	10	12	14	16	18	20
	Raggruppati e in contatto tra loro e posati su pavimento, su parete, in condotto o tubo anche all'interno della parete. <i>Bunched directly and in touch between each other on floors, on walls, in conduits or in wireways or in the wall.</i> 	1,00	0,80	0,70	0,65	0,60	0,57	0,54	0,52	0,50	0,48	0,45	0,43	0,41	0,39
In singolo strato a contatto tra loro e posati su pavimento o su parete. <i>In one layer in touch between each other on floors or attached to walls.</i> 	1,00	0,85	0,79	0,75	0,73	0,72	0,72	0,71	0,70	0,70	0,70	0,70	0,70	0,70	0,70
In singolo strato ad una distanza pari al valore del diametro esterno "d" e posati su pavimento o su parete. <i>In one layer with a clearance equal to the external diameter "d" on floors or attached to walls</i> 	1,00	0,94	0,90	0,90	0,90	0,90	0,90	0,90	0,90	0,90	0,90	0,90	0,90	0,90	0,90
In singolo strato a contatto tra loro e posati a soffitto. <i>In one layer in touch between each other under the ceiling.</i> 	0,95	0,81	0,72	0,68	0,66	0,64	0,63	0,62	0,61	0,61	0,61	0,61	0,61	0,61	0,61
In singolo strato ad una distanza pari al valore del diametro esterno "d" e posati a soffitto. <i>In one layer with a clearance equal to the external diameter "d" under the ceiling.</i> 	0,95	0,85	0,85	0,85	0,85	0,85	0,85	0,85	0,85	0,85	0,85	0,85	0,85	0,85	0,85

Nota 1. I fattori di correzione possono essere applicati solo a cavi caricati in modo simile, con la stessa modalità di installazione e quando le sezioni nominali differiscono solo di un livello.

Nota 2. Se la distanza tra cavi supera di 2 volte il loro diametro esterno, non è necessario applicare alcun fattore di correzione.

Nota 3. Per un sistema costituito da cavi multipolari si deve considerare il numero totale dei circuiti costituiti da cavi multipolari. Il fattore di correzione deve essere applicato alla portata del cavo in relazione al numero di conduttori alimentati (2 o 3).

Nota 4. Per un sistema costituito da n cavi unipolari, il fattore di correzione da applicare alla portata del cavo è in relazione al numero di circuiti pari a n/2 oppure n/3 a seconda del numero dei conduttori alimentati nel circuito.

Note 1. Correction factors can be applied only to similar loaded cables of a similar type of installation and nominal cross sections differ one step only.

Note 2. If the actual horizontal-space between adjacent cables is more than double of the outer diameter, no correction factor is necessary.

Note 3. For a system consisting of multicore cables, the number of circuits have to be considered. The correction factor has to be applied to the ampacity of the two or three current carrying conductors in the cables.

Note 4. If the grouping of single core cables consists of n loaded single core cables, the correction factor shall be determinate for n/2 or n/3 circuits depending on the number of current-carrying conductors.

Tabella B.8g. Fattori di correzione per circuiti di cavi unipolari installati in canaline secondo VDE 0298-4 – Ed. 2013 - Tabelle 23
 Table B.8g. Correction factors for single-core cables' circuits installed in cable trays according to VDE 0298-4 – Ed. 2013 - Tabelle 23

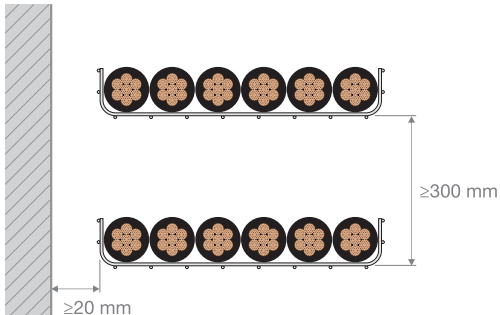
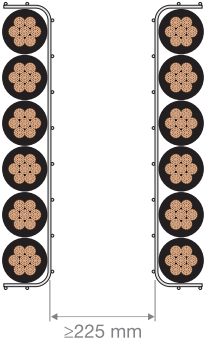
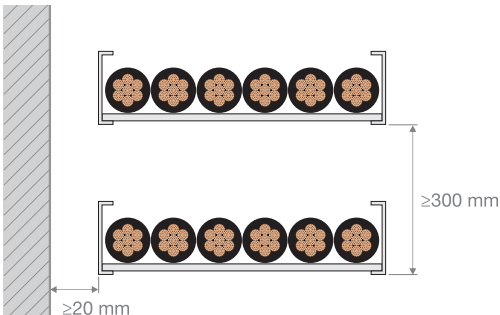
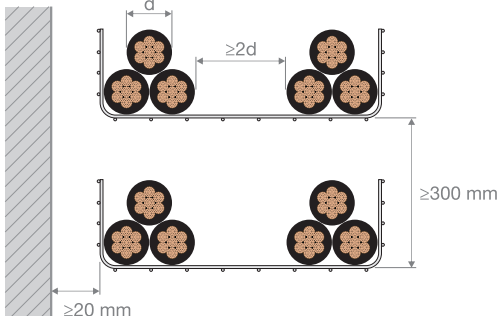
Metodo di installazione <i>Installation method</i>	Numero di canaline <i>Number of cable trays</i>	Numero di circuiti trifase costituiti da cavi unipolari <i>Number of three-phase circuits of single-core cables</i>		
		1	2	3
		Fattore di correzione <i>Correction factor</i>		
Singolo strato in contatto tra loro e posa in canaline ventilate disposte orizzontalmente. <i>Single layer in touch between each other in ventilated cable trays in a horizontal plane arrangement.</i> 	1	0,98	0,91	0,87
	2	0,96	0,87	0,81
	3	0,95	0,85	0,78
Singolo strato in contatto tra loro e posa in canaline ventilate disposte verticalmente. <i>Single layer between each other in ventilated cable trays in a vertical plane arrangement.</i> 	1	0,96	0,86	-
	2	0,95	0,84	-
Singolo strato in contatto tra loro e posa in canaline a scaletta disposte orizzontalmente. <i>Single layer between each other in cable ladders in a horizontal plane arrangement.</i> 	1	1,00	0,97	0,96
	2	0,98	0,93	0,89
	3	0,97	0,90	0,86
Configurazione a triangolo e posa in canaline ventilate disposte orizzontalmente. <i>Delta configuration in ventilated cable trays in a horizontal plane arrangement.</i> 	1	1,00	0,98	0,96
	2	0,97	0,93	0,89
	3	0,96	0,92	0,86

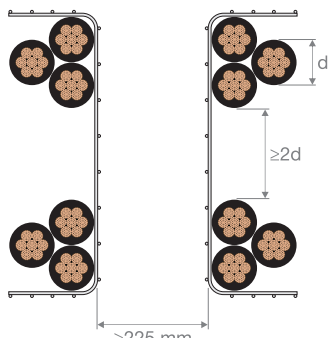
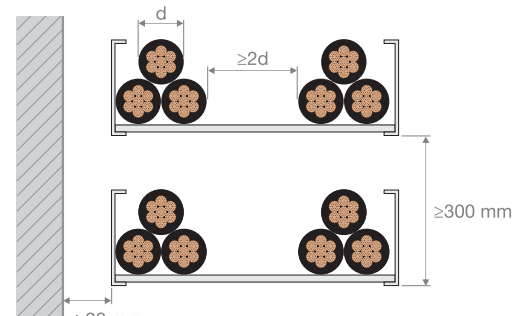
Metodo di installazione <i>Installation method</i>	Numero di canaline <i>Number of cable trays</i>	Numero di circuiti trifase costituiti da cavi unipolari <i>Number of three-phase circuits of single-core cables</i>		
		1	2	3
		Fattore di correzione <i>Correction factor</i>		
<p>Configurazione a triangolo e posa in canaline ventilate disposte verticalmente. <i>Delta configuration in ventilated cable trays in a vertical plane arrangement.</i></p> 	1	1,00	0,91	0,89
2	1,00	0,90	0,86	
<p>Configurazione a triangolo e posa in canaline a scaletta disposte orizzontalmente. <i>Delta configuration in cable ladders in a horizontal plane arrangement.</i></p> 	1	1,00	1,00	1,00
2	0,97	0,95	0,93	
3	0,96	0,94	0,90	

Nota 1. Quando i cavi sono posati su più strati o quando la distanza non è in accordo a quanto indicato in tabella è necessario applicare ulteriori fattori di correzione, per esempio quelli indicati in tabella B.8f.
 Note 1. If the cables are lying on top to each other as well as if minimum distance required is not guaranteed, extra correction factors must be applied, i.e. correction factors of table B.8f.

Tabella B.8h. Fattori di correzione per cavi multipolari installati in canaline secondo VDE 0298-4 – Ed. 2013 - Tabelle 22
 Table B.8h. Correction factors for multicore cables installed in cable trays according to VDE 0298-4 – Ed. 2013 - Tabelle 22

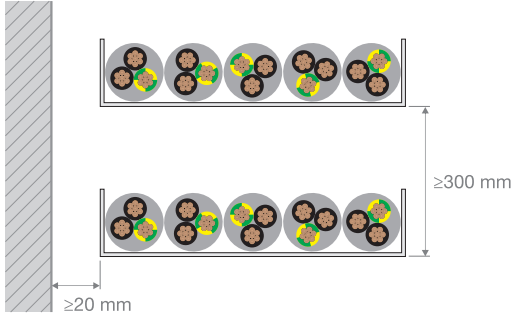
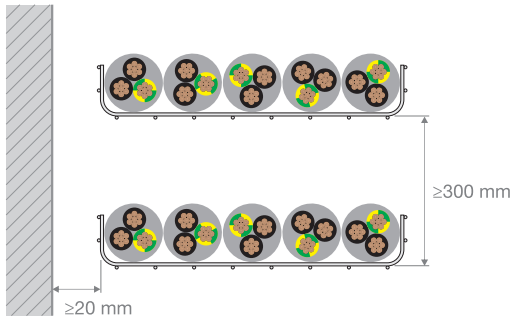
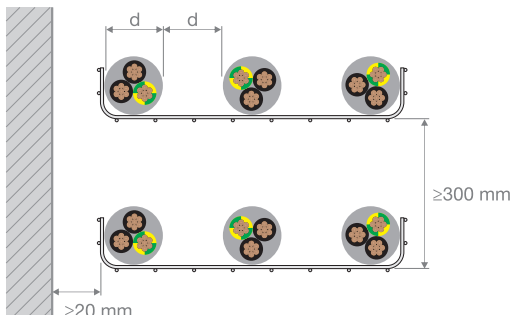
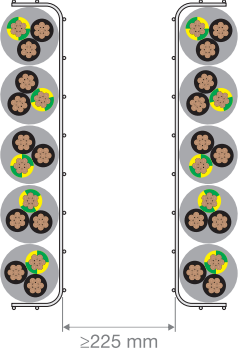
Metodo di installazione <i>Installation method</i>	Numero di canaline <i>Number of cable trays</i>	Numero di cavi multipolari <i>Number of multicore cables</i>					
		1	2	3	4	6	9
		Fattore di correzione <i>Correction factor</i>					
Singolo strato in contatto tra loro e posa in canaline non ventilate disposte orizzontalmente. <i>Single layer in touch between each other in non ventilated cable trays in a horizontal plane arrangement.</i> 	1	0,97	0,84	0,78	0,75	0,71	0,68
	2	0,97	0,83	0,76	0,72	0,68	0,63
	3	0,97	0,82	0,75	0,71	0,66	0,61
	6	0,97	0,81	0,73	0,69	0,63	0,58
Singolo strato in contatto tra loro e posa in canaline ventilate disposte orizzontalmente. <i>Single layer in touch between each other in ventilated cable trays in a horizontal plane arrangement.</i> 	1	1,00	0,88	0,82	0,79	0,76	0,73
	2	1,00	0,87	0,80	0,77	0,73	0,68
	3	1,00	0,86	0,79	0,76	0,71	0,66
	6	1,00	0,84	0,77	0,73	0,68	0,64
Singolo strato ad una distanza pari al valore del diametro esterno "d" e posa in canaline ventilate disposte orizzontalmente. <i>Single layer with a clearance equal to the external diameter "d" in ventilated cable trays in a horizontal plane arrangement.</i> 	1	1,00	1,00	0,98	0,95	0,91	-
	2	1,00	0,99	0,96	0,92	0,87	-
	3	1,00	0,98	0,95	0,91	0,85	-
Singolo strato in contatto tra loro e posa in canaline ventilate disposta verticalmente. <i>Single layer between each other in ventilated cable trays in a vertical plane arrangement.</i> 	1	1,00	0,88	0,82	0,78	0,73	0,72
	2	1,00	0,88	0,81	0,76	0,71	0,70

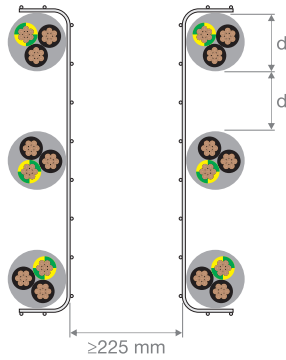
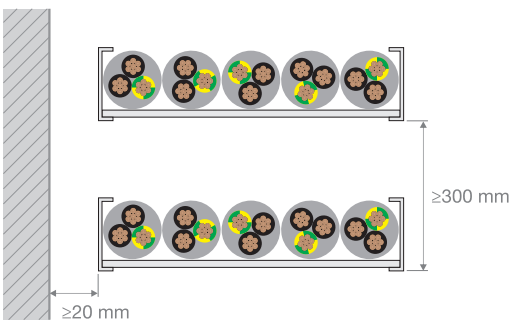
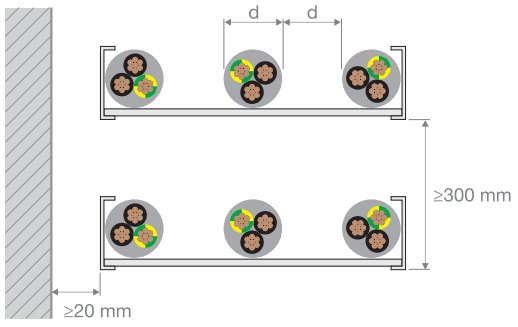
Metodo di installazione <i>Installation method</i>	Numero di canaline <i>Number of cable trays</i>	Numero di cavi multipolari <i>Number of multicore cables</i>					
		1	2	3	4	6	9
		Fattore di correzione <i>Correction factor</i>					
<p>Singolo strato ad una distanza pari al valore del diametro esterno "d" e posa in canaline ventilate disposta verticalmente. <i>Single layer with a clearance equal to the external diameter "d" in ventilated cable trays in a vertical plane arrangement.</i></p> 	1	1,00	0,91	0,89	0,88	0,87	-
<p>Singolo strato in contatto tra loro e posa in canaline a scaletta disposta orizzontalmente. <i>Single layer between each other in cable ladders in a horizontal plane arrangement.</i></p> 	1	1,00	0,87	0,82	0,80	0,79	0,78
	2	1,00	0,86	0,81	0,78	0,76	0,73
	3	1,00	0,85	0,79	0,76	0,73	0,70
	6	1,00	0,83	0,76	0,73	0,69	0,66
<p>Singolo strato ad una distanza pari al valore del diametro esterno "d" e posa in canaline a scaletta disposta orizzontalmente. <i>Single layer with a clearance equal to the external diameter "d" in cable ladders in a horizontal plane arrangement.</i></p> 	1	1,00	1,00	1,00	1,00	1,00	-
	2	1,00	0,99	0,98	0,97	0,96	-
	3	1,00	0,98	0,97	0,96	0,93	-

Nota 1. Quando i cavi sono posati su più strati o quando la distanza non è in accordo a quanto indicato in tabella è necessario applicare ulteriori fattori di correzione, per esempio quelli indicati in tabella B.8f.
 Note 1. If the cables are lying on top to each other as well as if minimum distance required is not guaranteed, extra correction factors must be applied, i.e. correction factors of table B.8f.

B.9 Portate dei conduttori secondo IEC 60364-5-52/CEI UNEL 35024-1/CEI 64-8 Ampacities of conductors according to IEC 60364-5-52/CEI UNEL 35024-1/CEI 64-8

Le tabelle mostrano le portate dei conduttori pubblicate nella norma alla quale si deve fare sempre riferimento.
The tables show the ampacities of the conductors published in the standard to which reference must always be made.

Tabella B.9a. Portate di cavi unipolari con isolamento termoplastico in ambiente a 30°C secondo IEC 60364-5-52/CEI UNEL 35024-1/CEI 64-8
Table B.9a. Ampacities of single-core cables with thermoplastic insulation at 30°C ambient temperature according to IEC 60364-5-52/CEI UNEL 35024-1/CEI 64-8

Sezione del conduttore Conductor's size [mm ²]	Tipo di cavo Type of cable									
	Cavi unipolari con isolamento termoplastico tipo PVC 60°C, PVC 75°C, PVC 80°C con tensioni fino a 1000V a.c. e 1500V d.c. – temperatura ambiente 30°C Single core cables with thermoplastic insulation such as PVC 60°C, PVC 75°C and PVC 80°C with voltage rating up to 1000V a.c. or 1500V d.c. – ambient temperature 30°C									
	Metodo di installazione base Base method of installation									
	Cavi a trifoglio in aria Trefoil cables in air	Cavi in tubazione posta in aria Cables in conduit in air		Cavi in piano a contatto tra loro in aria Cables on a surface in contact with each other in air		Cavi in piano orizzontale a distanza tra loro in aria Cables on a horizontal surface at a distance between them in air		Cavi in piano verticale a distanza tra loro in aria Cables on a vertical surface at a distance between them in air		
	Riferimento ai metodi di installazione indicati nelle norme Reference to the installation methods indicated in the standards									
	UNEL 35024-1/CEI 64-8 Met. 11, 12, 21, 25, 43, 52, 53	UNEL 35024-1/CEI 64-8 Met. 3, 4, 5, 22, 23, 24, 31, 32, 33, 34, 41, 42, 72		UNEL 35024-1/CEI 64-8 Met. 13, 14, 15, 16, 17		UNEL 35024-1/CEI 64-8 Met. 14, 15, 16		UNEL 35024-1/CEI 64-8 Met. 13, 14, 15, 16		
	IEC 60364-5-52 Met. F Tab. B.52.10 (5)	IEC 60364-5-52 Met. B1 Tab. B.52.2 (4), B.52.4 (4)		IEC 60364-5-52 Met. F Tab. B.52.10 (4), B.52.10 (6)		IEC 60364-5-52 Met. G Tab. B.52.10 (7)		IEC 60364-5-52 Met. G Tab. B.52.10 (8)		
	Riferimento ad altri metodi di installazione ¹⁾ Reference to other installation methods ¹⁾									
	Schemi U1-3 Diagrams U1-3	Schemi U2-2 Diagrams U2-2	Schemi U2-3 Diagrams U2-3	Schemi U3-2 Diagrams U3-2	Schemi U3-3 Diagrams U3-3	Schemi U4-2 Diagrams U4-2	Schemi U4-3 Diagrams U4-3	Schemi U5-2 Diagrams U5-2	Schemi U5-3 Diagrams U5-3	
Numero di conduttori alimentati Number of current carrying conductors										
3		2		3		2		3		
Portata massima [A] ²⁾ Allowable ampacity [A] ²⁾										
0,5	8	9	8	11	9	12	12	10	10	
0,75	11	11	10	14	11	16	16	13	13	
1	13	13,5	12	17	14	19	19	16	16	
1,5	19,5	17,5	15,5	22	19,5	24	24	21	21	
2,5	26	24	21	30	26	34	34	29	29	
4	35	32	28	40	35	45	45	39	39	
6	46	41	36	52	46	59	59	51	51	
10	63	57	50	71	63	81	81	71	71	
16	85	76	68	96	85	110	110	97	97	
25	110	101	89	131	114	146	146	130	130	
35	137	125	110	162	143	181	181	162	162	
50	167	151	134	196	174	219	219	197	197	
70	216	192	171	251	225	281	281	254	254	
95	264	232	207	304	275	341	341	311	311	
120	308	269	239	352	321	396	396	362	362	
150	356	309	275	406	372	456	456	419	419	
185	409	353	314	463	427	521	521	480	480	
240	485	415	369	546	507	615	615	569	569	
300	561	477	426	629	587	709	709	659	659	
400	656	571	510	754	689	852	852	795	795	
500	759	656	587	868	789	982	982	920	920	
630	855	758	678	1005	905	1138	1138	1070	1070	

¹⁾ Si faccia riferimento alla tabella Tabella B.9c e alle norme per maggiori dettagli. / Refer to Table B.9c and to the standards for more details.

²⁾ I valori non pubblicati nelle norme di riferimento sono stati calcolati mediante le curve di interpolazione suggerite dalla norma IEC 60364-5-52. / The values not published in the Standards have been calculated using the interpolation curves suggested by the IEC 60364-5-52 norm.

Tabella B.9b. Portate di cavi unipolari con isolamento elastomerico in ambiente a 30°C secondo IEC 60364-5-52/CEI UNEL 35024-1/CEI 64-8

Table B.9b. Ampacities of single-core cables with elastomeric insulation at 30°C ambient temperature according to IEC 60364-5-52/CEI UNEL 35024-1/CEI 64-8

Sezione del conduttore Conductor's size [mm ²]	Tipo di cavo Type of cable									
	Cavi unipolari con isolamento elastomerico tipo XLPE, TPE, PUR, Silicone, Gomma oppure PVC 90°C con tensioni fino a 1000V a.c. e 1500V d.c. temperatura ambiente 30°C Single-core cables with thermoplastic insulation such as XLPE, TPE, PUR, Silicon, Rubber or PVC 90°C with voltage rating up to 1000V a.c. or 1500V d.c. ambient temperature 30°C									
	Metodo di installazione base Base method of installation									
	Cavi a trifoglio in aria Trefoil cables in air	Cavi in tubazione posta in aria Cables in conduit in air		Cavi in piano a contatto tra loro in aria Cables on a surface in contact with each other in air		Cavi in piano orizzontale a distanza tra loro in aria Cables on a horizontal surface at a distance between them in air		Cavi in piano verticale a distanza tra loro in aria Cables on a vertical surface at a distance between them in air		
	Riferimento ai metodi di installazione indicati nelle norme Reference to the installation methods indicated in the standards									
	UNEL 35024-1/CEI 64-8 Met. 11, 12, 21, 25, 43, 52, 53	UNEL 35024-1/CEI 64-8 Met. 3, 4, 5, 22, 23, 24, 31, 32, 33, 34, 41, 42, 72		UNEL 35024-1/CEI 64-8 Met. 13, 14, 15, 16, 17		UNEL 35024-1/CEI 64-8 Met. 14, 15, 16		UNEL 35024-1/CEI 64-8 Met. 13, 14, 15, 16		
	IEC 60364-5-52 Met. F Tab. B.52.12 (5)	IEC 60364-5-52 Met. B1 Tab. B.52.3 (4), B.52.5 (4)		IEC 60364-5-52 Met. F Tab. B.52.12 (4), B.52.12 (6)		IEC 60364-5-52 Met. G Tab. B.52.12 (7)		IEC 60364-5-52 Met. G Tab. B.52.12 (8)		
	Riferimento ad altri metodi di installazione ⁽¹⁾ Reference to other installation methods ⁽¹⁾									
	Schemi U1-3 Diagrams U1-3	Schemi U2-2 Diagrams U2-2	Schemi U2-3 Diagrams U2-3	Schemi U3-2 Diagrams U3-2	Schemi U3-3 Diagrams U3-3	Schemi U4-2 Diagrams U4-2	Schemi U4-3 Diagrams U4-3	Schemi U5-2 Diagrams U5-2	Schemi U5-3 Diagrams U5-3	
Numero di conduttori alimentati Number of current carrying conductors										
3	2	3	2	3	2	3	2	3		
Portata massima [A] ⁽²⁾ Allowable ampacity [A] ⁽²⁾										
0,5	10	12	10	13	10	15	15	12	12	
0,75	13	15	13	17	14	19	19	16	16	
1	16	17	15	21	17	23	23	19	19	
1,5	24	23	20	27	24	30	30	25	25	
2,5	33	31	28	37	33	41	41	35	35	
4	45	42	37	50	45	56	56	48	48	
6	58	54	48	64	58	73	73	63	63	
10	80	75	66	88	80	101	101	88	88	
16	107	100	88	119	107	137	137	120	120	
25	135	133	117	161	141	182	182	161	161	
35	169	164	144	200	176	226	226	201	201	
50	207	198	175	242	216	275	275	246	246	
70	268	253	222	310	279	353	353	318	318	
95	328	306	269	377	342	430	430	389	389	
120	383	354	312	437	400	500	500	454	454	
150	444	402	355	504	464	577	577	527	527	
185	510	472	417	575	533	661	661	605	605	
240	607	555	490	679	634	781	781	719	719	
300	703	628	553	783	736	902	902	833	833	
400	823	751	661	940	868	1085	1085	1008	1008	
500	946	864	760	1083	998	1253	1253	1169	1169	
630	1088	998	879	1254	1151	1454	1454	1362	1362	

⁽¹⁾ Si faccia riferimento alla tabella Tabella B.9c e alle norme per maggiori dettagli. / Refer to Table B.9c and to the standards for more details.

⁽²⁾ I valori non pubblicati nelle norme di riferimento sono stati calcolati mediante le curve di interpolazione suggerite dalla norma IEC 60364-5-52. / The values not published in the Standards have been calculated using the interpolation curves suggested by the IEC 60364-5-52 norm.

Tabella B.9c. Altri metodi di installazione per cavi unipolari secondo IEC 60364-5-52/CEI UNEL 35024-1/CEI 64-8

Table B.9c. Other methods of installation of single-core cables according to IEC 60364-5-52/CEI UNEL 35024-1/CEI 64-8

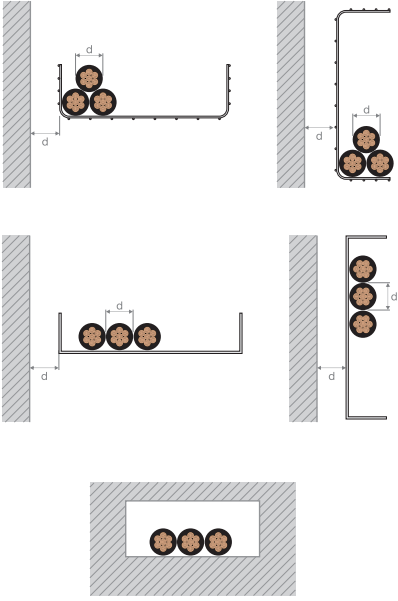
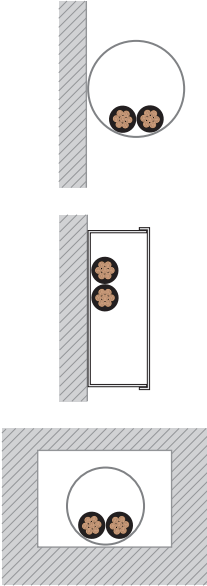
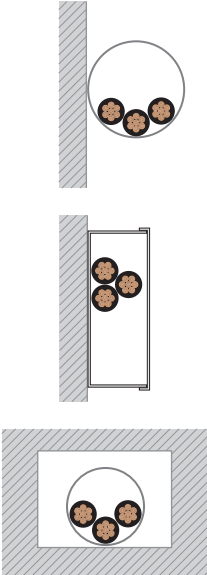
Schema Diagram	Immagini rappresentative Representative images	Note Note
U1-3		<p>Installazione a trifoglio su canaline aperte (a filo, asolate o a scaletta) in posizione verticale o orizzontale. <i>Trefoil installation on open cable trays (wire mesh, ventilated or ladder) in vertical or horizontal position.</i></p> <p>Installazione non a trifoglio su canaline non asolate e senza coperchio in posizione verticale o orizzontale. <i>Installation on non-ventilated cable trays without cover in vertical or horizontal position.</i></p> <p>Installazione in cavità di strutture o in cunicoli aperti o ventilati con percorso orizzontale o verticale per lunghezze massime di 0,5 m per cavi fino a 10 mm², 1 m per cavi fino a 95 mm² e 1,5 m per cavi oltre i 95 mm². <i>Installation in cavities of structures or in open or ventilated tunnels with horizontal or vertical path for maximum lengths of 0.5 m for cables up to 10 mm², 1 m for cables up to 95 mm² and 1.5 m for cables over 95 mm².</i></p>
U2-2		<p>Installazione in tubi protettivi posati su o distanziati da pareti. <i>Installation in conduits laid on or spaced from walls.</i></p> <p>Installazione in canali posati su parete in posizione verticale o orizzontale. <i>Installation in cable trunking on a wall in vertical or horizontal position.</i></p> <p>Installazione in tubi protettivi circolari o non circolari posati in cavità di strutture. <i>Installation in circular or non-circular conduits laid in cavities of structures.</i></p>
U2-3		<p>Installazione in tubi protettivi posati su o distanziati da pareti. <i>Installation in conduits laid on or spaced from walls.</i></p> <p>Installazione in canali posati su parete in posizione verticale o orizzontale. <i>Installation in cable trunking on a wall in vertical or horizontal position.</i></p> <p>Installazione in tubi protettivi circolari o non circolari posati in cavità di strutture. <i>Installation in circular or non-circular conduits laid in cavities of structures.</i></p>

Schema Diagram	Immagini rappresentative Representative images	Note Note
U3-2		<p>Installazione non a trifoglio su canaline aperte (a filo, asolate o a scaletta) in posizione verticale o orizzontale. <i>Installation on open cable trays (wire mesh, ventilated or ladder) in vertical or horizontal position.</i></p>
U3-3		<p>Installazione non a trifoglio su canaline aperte (a filo, asolate o a scaletta) in posizione verticale o orizzontale. <i>Installation on open cable trays (wire mesh, ventilated or ladder) in vertical or horizontal position.</i></p>
U4-2		<p>Installazione distanziata su canaline aperte (a filo, asolate o a scaletta) in posizione orizzontale. <i>Installation at a distance on open cable trays (wire mesh, ventilated or ladder) in horizontal position.</i></p>
U4-3		<p>Installazione distanziata su canaline aperte (a filo, asolate o a scaletta) in posizione orizzontale. <i>Installation at a distance on open cable trays (wire mesh, ventilated or ladder) in horizontal position.</i></p>
U5-2		<p>Installazione distanziata su canaline aperte (a filo, asolate o a scaletta) in posizione verticale. <i>Installation at a distance on open cable trays (wire mesh, ventilated or ladder) in vertical position.</i></p>
U5-3		<p>Installazione distanziata su canaline aperte (a filo, asolate o a scaletta) in posizione verticale. <i>Installation at a distance on open cable trays (wire mesh, ventilated or ladder) in vertical position.</i></p>

Tabella B.9d. Portate di cavi multipolari con isolamento termoplastico in ambiente a 30°C secondo IEC 60364-5-52/CEI UNEL 35024-1/CEI 64-8

Table B.9d. Ampacities of multi-core cables with thermoplastic insulation at 30°C ambient temperature according to IEC 60364-5-52/CEI UNEL 35024-1/CEI 64-8

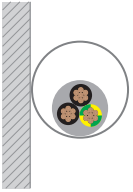
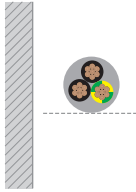
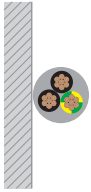
Sezione del conduttore Conductor's size [mm ²]	Tipo di cavo Type of cable					
	Cavi multipolari con isolamento termoplastico tipo PVC 60°C, PVC 75°C, PVC 80°C con tensioni fino a 1000V a.c. e 1500V d.c. – temperatura ambiente 30°C Multi-core cables with thermoplastic insulation such as PVC 60°C, PVC 75°C and PVC 80°C with voltage rating up to 1000V a.c. or 1500V d.c. – ambient temperature 30°C					
	Metodo di installazione base Base method of installation					
	Cavi in tubazione posta in aria Cables in conduit in air		Cavi in piano in aria Cables on a surface in air		Cavi a parete/soffitto in aria Cables on wall/ceiling in air	
						
	Riferimento ai metodi di installazione indicati nelle norme Reference to the installation methods indicated in the standards					
	UNEL 35024-1/CEI 64-8 Met. 3A, 4A, 5A, 21, 22A, 24A, 25, 31, 32, 33A, 34A, 43		UNEL 35024-1/CEI 64-8 Met. 13, 14, 15, 16, 17		UNEL 35024-1/CEI 64-8 Met. 11, 11A, 12, 52, 53	
	IEC 60364-5-52 Met. B2 Tab. B.52.2 (5), B.52.4 (5)		IEC 60364-5-52 Met. E Tab. B.52.10 (2), B.52.10 (3)		IEC 60364-5-52 Met. C Tab. B.52.2 (6), B.52.4 (6)	
	Riferimento ad altri metodi di installazione ⁽¹⁾ Reference to other installation methods ⁽¹⁾					
	Schemi M1-2 Diagrams M1-2		Schemi M1-3 Diagrams M1-3		Schemi M3-3 Diagrams M3-3	
		Schemi M2-2 Diagrams M2-2		Schemi M2-3 Diagrams M2-3		
				Schemi M3-2 Diagrams M3-2		
Numero di conduttori alimentati Number of current carrying conductors						
2		3		3		
		2		2		
Portata massima [A] ⁽²⁾ Allowable ampacity [A] ⁽²⁾						
0,5	9	8	11	9	10	9
0,75	11	10	14	12	13	11
1	13,5	12	15	13,6	15	13,5
1,5	16,5	15	22	18,5	19,5	17,5
2,5	23	20	30	25	27	24
4	30	27	40	34	36	32
6	38	34	51	43	46	41
10	52	46	70	60	63	57
16	69	62	94	80	85	76
25	90	80	119	101	112	96
35	111	99	148	126	138	119
50	133	118	180	153	168	144
70	168	149	232	196	213	184
95	201	179	282	238	258	223
120	232	206	328	276	299	259
150	258	225	379	319	344	299
185	294	255	434	364	392	341
240	344	297	514	430	461	403
300	394	339	593	497	530	464
400	477	425	715	597	634	557
500	545	486	826	689	729	642
630	626	559	958	798	843	743

⁽¹⁾ Si faccia riferimento alla tabella Tabella B.9f e alle norme per maggiori dettagli. / Refer to Table B.9f and to the standards for more details.

⁽²⁾ I valori non pubblicati nelle norme di riferimento sono stati calcolati mediante le curve di interpolazione suggerite dalla norma IEC 60364-5-52. / The values not published in the Standards have been calculated using the interpolation curves suggested by the IEC 60364-5-52 norm.

Tabella B.9e. Portate di cavi multipolari con isolamento elastomerico in ambiente a 30°C secondo IEC 60364-5-52/CEI UNEL 35024-1/CEI 64-8

Table B.9e. Ampacities of multi-core cables with elastomeric insulation at 30°C ambient temperature according to IEC 60364-5-52/CEI UNEL 35024-1/CEI 64-8

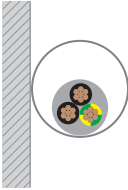
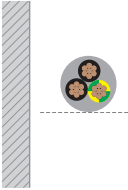
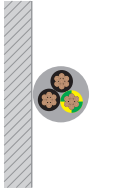
Sezione del conduttore Conductor's size [mm ²]	Tipo di cavo Type of cable					
	Cavi multipolari con isolamento elastomerico tipo XLPE, TPE, PUR, Silicone, Gomma oppure PVC 90°C con tensioni fino a 1000V a.c. e 1500V d.c. temperatura ambiente 30°C Multi-core cables with thermoplastic insulation such as XLPE, TPE, PUR, Silicon, Rubber or PVC 90°C with voltage rating up to 1000V a.c. or 1500V d.c. ambient temperature 30°C					
	Metodo di installazione base Base method of installation					
	Cavi in tubazione posta in aria Cables in conduit in air		Cavi in piano in aria Cables on a surface in air		Cavi a parete/soffitto in aria Cables on wall/ceiling in air	
						
	Riferimento ai metodi di installazione indicati nelle norme Reference to the installation methods indicated in the standards					
	UNEL 35024-1/CEI 64-8 Met. 3A, 4A, 5A, 21, 22A, 24A, 25, 31, 32, 33A, 34A, 43		UNEL 35024-1/CEI 64-8 Met. 13, 14, 15, 16, 17		UNEL 35024-1/CEI 64-8 Met. 11, 11A, 12, 52, 53	
	IEC 60364-5-52 Met. B2 Tab. B.52.3 (5), B.52.5 (5)		IEC 60364-5-52 Met. E Tab. B.52.12 (2), B.52.12 (3)		IEC 60364-5-52 Met. C Tab. B.52.3 (6), B.52.5 (6)	
	Riferimento ad altri metodi di installazione ⁽¹⁾ Reference to other installation methods ⁽¹⁾					
	Schemi M1-2 Diagrams M1-2		Schemi M1-3 Diagrams M1-3		Schemi M3-2 Diagrams M3-2	
				Schemi M2-2 Diagrams M2-2		
				Schemi M2-3 Diagrams M2-3		
				Schemi M3-3 Diagrams M3-3		
Numero di conduttori alimentati Number of current carrying conductors						
2		3		3		
				2		
				3		
Portata massima [A] ⁽²⁾ Allowable ampacity [A] ⁽²⁾						
0,5	11	10	13	12	11	
0,75	15	13	17	15	14	
1	17	15	19	17	17	
1,5	22	19,5	26	23	22	
2,5	30	26	36	32	30	
4	40	35	49	42	40	
6	51	44	63	54	52	
10	69	60	86	75	71	
16	91	80	115	100	96	
25	119	105	149	127	119	
35	146	128	185	158	147	
50	175	154	225	192	179	
70	221	194	289	246	229	
95	265	233	352	298	278	
120	305	268	410	346	322	
150	334	300	473	399	371	
185	384	340	542	456	424	
240	459	398	641	538	500	
300	532	455	741	621	576	
400	628	552	892	745	710	
500	718	631	1030	859	816	
630	825	725	1196	995	943	

⁽¹⁾ Si faccia riferimento alla tabella Tabella B.9f e alle norme per maggiori dettagli. / Refer to Table B.9f and to the standards for more details.

⁽²⁾ I valori non pubblicati nelle norme di riferimento sono stati calcolati mediante le curve di interpolazione suggerite dalla norma IEC 60364-5-52. / The values not published in the Standards have been calculated using the interpolation curves suggested by the IEC 60364-5-52 norm.

Tabella B.9f. Altri metodi di installazione per cavi unipolari secondo IEC 60364-5-52/CEI UNEL 35024-1/CEI 64-8
 Table B.9f. Other methods of installation of single-core cables according to IEC 60364-5-52/CEI UNEL 35024-1/CEI 64-8

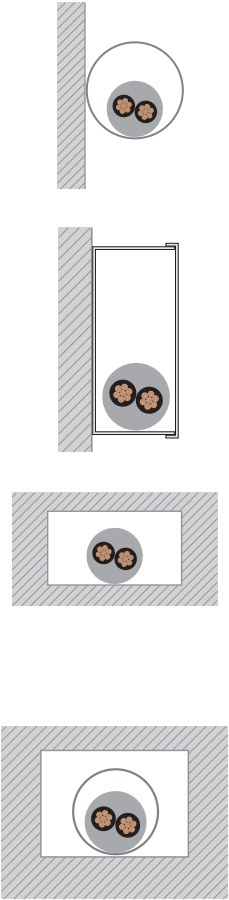
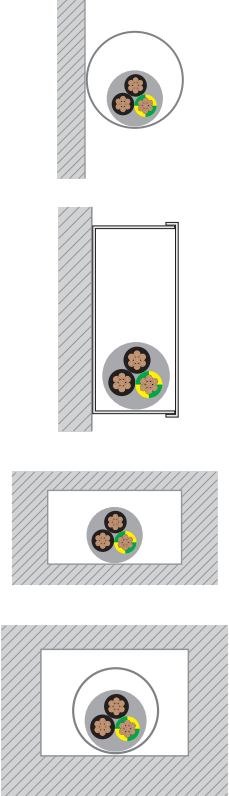
Schema Diagram	Immagini rappresentative Representative images	Note Note
M1-2		<p>Installazione in tubi protettivi posati su o distanziati da pareti. <i>Installation in conduits laid on or spaced from walls.</i></p> <p>Installazione in canali posati su parete in posizione verticale o orizzontale <i>Installation in cable trunking on a wall in vertical or horizontal position.</i></p> <p>Installazione in cavità di strutture o in cunicoli aperti o ventilati con percorso orizzontale o verticale per lunghezze massime di 0,5 m per cavi fino a 10 mm², 1 m per cavi fino a 95 mm² e 1,5 m per cavi oltre i 95 mm². <i>Installation in cavities of structures or in open or ventilated tunnels with horizontal or vertical path for maximum lengths of 0.5 m for cables up to 10 mm², 1 m for cables up to 95 mm² and 1.5 m for cables over 95 mm².</i></p> <p>Installazione in tubi protettivi in cavità di strutture o in cunicoli aperti o ventilati con percorso orizzontale o verticale per lunghezze massime di 0,5 m per cavi fino a 10 mm², 1 m per cavi fino a 95 mm² e 1,5 m per cavi oltre i 95 mm². <i>Installation in conduits laid in cavities of structures or in open or ventilated tunnels with horizontal or vertical path for maximum lengths of 0.5 m for cables up to 10 mm², 1 m for cables up to 95 mm² and 1.5 m for cables over 95 mm².</i></p>
M1-3		<p>Installazione in tubi protettivi posati su o distanziati da pareti. <i>Installation in conduits laid on or spaced from walls.</i></p> <p>Installazione in canali posati su parete in posizione verticale o orizzontale. <i>Installation in cable trunking on a wall in vertical or horizontal position.</i></p> <p>Installazione in cavità di strutture o in cunicoli aperti o ventilati con percorso orizzontale o verticale per lunghezze massime di 0,5 m per cavi fino a 10 mm², 1 m per cavi fino a 95 mm² e 1,5 m per cavi oltre i 95 mm². <i>Installation in cavities of structures or in open or ventilated tunnels with horizontal or vertical path for maximum lengths of 0.5 m for cables up to 10 mm², 1 m for cables up to 95 mm² and 1.5 m for cables over 95 mm².</i></p> <p>Installazione in tubi protettivi in cavità di strutture o in cunicoli aperti o ventilati con percorso orizzontale o verticale per lunghezze massime di 0,5 m per cavi fino a 10 mm², 1 m per cavi fino a 95 mm² e 1,5 m per cavi oltre i 95 mm². <i>Installation in conduits laid in cavities of structures or in open or ventilated tunnels with horizontal or vertical path for maximum lengths of 0.5 m for cables up to 10 mm², 1 m for cables up to 95 mm² and 1.5 m for cables over 95 mm².</i></p>

Schema Diagram	Immagini rappresentative Representative images	Note Note
M2-2		<p>Installazione su canaline aperte (a filo, asolate o a scaletta) in posizione verticale o orizzontale. <i>Installation on open cable trays (wire mesh, ventilated or ladder) in vertical or horizontal position.</i></p>
M2-3		<p>Installazione su canaline aperte (a filo, asolate o a scaletta) in posizione verticale o orizzontale. <i>Installation on open cable trays (wire mesh, ventilated or ladder) in vertical or horizontal position.</i></p>
M3-2		<p>Installazione su o distanziati da pareti. <i>Installation on or spaced from walls.</i></p> <p>Installazione su canaline non asolate e senza coperchio in posizione verticale o orizzontale. <i>Installation on non-ventilated cable trays without cover in vertical or horizontal position.</i></p>
M3-3		<p>Installazione su o distanziati da pareti. <i>Installation on or spaced from walls.</i></p> <p>Installazione su canaline non asolate e senza coperchio in posizione verticale o orizzontale. <i>Installation on non-ventilated cable trays without cover in vertical or horizontal position.</i></p>

Ai valori di portata indicati nelle tabelle precedenti è necessario applicare i fattori correttivi che tengono conto delle condizioni di posa ed in particolare della temperatura ambiente e del numero di circuiti presenti. Per circuito si intende un cavo tripolare o bipolare oppure tre cavi unipolari in un sistema trifase oppure due cavi unipolari in un sistema fase-fase o fase-terra. Per temperature ambiente diverse da 30°C si utilizzi la tabella B.9g.

Per installazioni di più circuiti di cavi unipolari o multipolari su pareti, pavimenti, soffitti, canaline non ventilate o in tubi si utilizzi la Tabella B.8f.

Per installazioni di circuiti di cavi unipolari su canaline si utilizzi la Tabella B.8g.

Per installazioni di circuiti di cavi multipolari su canaline si utilizzi la Tabella B.8h.

To the ampacities indicated in the previous tables it is necessary to apply the correction factors that take into account the installation configuration and in particular the ambient temperature and the number of circuits. By circuit we mean a three-core or two-core cable or three single-core cables in a three-phase system or two single-core cables in a phase-phase or phase-ground system.

For ambient temperatures other than 30°C use Table B.9g.

For installations of single-core or multi-core cable circuits on walls, floors, ceilings, non-ventilated cable trays or conduits use Table B.8f.

For installations of single-core cable circuits in cable trays use Table B.8g.

For installations of multi-core cables in cable trays use Table B.8h.

Tabella B.9g. Fattori di correzione delle portate in funzione della temperatura ambiente e della temperatura dell'isolamento

Table B.9g. Correction factors for the ampacities for different ambient temperatures and different insulation temperatures of cables

Temperatura ambiente <i>Ambient temperature</i>	Temperatura dell'isolamento <i>Insulation temperature</i>				
	60°C	70°C	75°C	80°C	90°C
	Fattore di correzione <i>Correction factor</i>				
10	1,29	1,22	1,20	1,18	1,15
15	1,22	1,17	1,15	1,14	1,12
20	1,15	1,12	1,11	1,10	1,08
25	1,08	1,06	1,05	1,05	1,04
30	1,00	1,00	1,00	1,00	1,00
35	0,91	0,94	0,94	0,95	0,96
40	0,82	0,87	0,88	0,89	0,91
45	0,71	0,79	0,82	0,84	0,87
50	0,58	0,71	0,75	0,77	0,82
55	0,41	0,61	0,67	0,71	0,76
60	-	0,50	0,58	0,63	0,71
65	-	0,35	0,47	0,55	0,65
70	-	-	0,33	0,45	0,58
75	-	-	-	0,32	0,50
80	-	-	-	-	0,41
85	-	-	-	-	0,29

Tabella B.9h. Fattori di correzione per circuiti di cavi unipolari e multipolari installati su pareti, pavimenti, soffitti, canaline non ventilate o in tubi
Table B.9h. Correction factors for single-core and multicore cables' circuits on surfaces, walls, ceiling, non-ventilated cable trays or in conduits

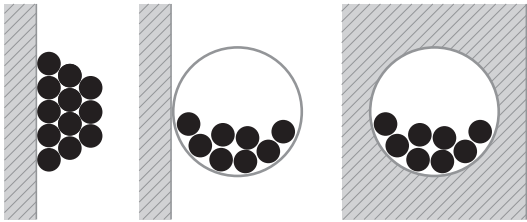
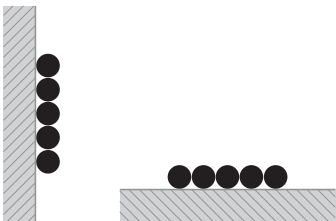
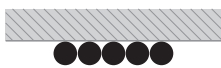
Metodo di installazione <i>Installation method</i>	Numero di cavi multipolari o numero di circuiti costituiti da cavi unipolari (2 o 3 conduttori alimentati) <i>Number of multi-core cables or number of circuits of single-core cables (2 or 3 current-carrying conductors)</i>														
	1	2	3	4	5	6	7	8	9	10	12	14	16	18	20
	Fattore di correzione <i>Correction factor</i>														
<p>Raggruppati e in contatto tra loro e posati su pavimento, su parete, in condotto o tubo anche all'interno della parete. <i>Bunched directly and in touch between each other on floors, on walls, in conduits or in wireways or in the wall.</i></p> 	1,00	0,80	0,70	0,65	0,60	0,57	0,54	0,52	0,50	0,48	0,45	0,43	0,41	0,39	0,38
<p>In singolo strato a contatto tra loro e posati su pavimento o su parete. <i>In one layer in touch between each other on floors or attached to walls.</i></p> 	1,00	0,85	0,79	0,75	0,73	0,72	0,72	0,71	0,70	0,70	0,70	0,70	0,70	0,70	0,70
<p>In singolo strato a contatto tra loro e posati a soffitto. <i>In one layer in touch between each other under the ceiling.</i></p> 	0,95	0,81	0,72	0,68	0,66	0,64	0,63	0,62	0,61	0,61	0,61	0,61	0,61	0,61	0,61

Nota 1. I fattori di correzione possono essere applicati solo a cavi caricati in modo simile, con la stessa modalità di installazione e quando le sezioni nominali differiscono solo di un livello.

Nota 2. Se la distanza tra cavi supera di 2 volte il loro diametro esterno, non è necessario applicare alcun fattore di correzione.

Nota 3. Per un sistema costituito da cavi multipolari si deve considerare il numero totale dei circuiti costituiti da cavi multipolari. Il fattore di correzione deve essere applicato alla portata del cavo in relazione al numero di conduttori alimentati (2 o 3).

Nota 4. Per un sistema costituito da n cavi unipolari, il fattore di correzione da applicare alla portata del cavo è in relazione al numero di circuiti pari a n/2 oppure n/3 a seconda del numero dei conduttori alimentati nel circuito.

Note 1. Correction factors can be applied only to similar loaded cables of a similar type of installation and nominal cross sections differ one step only.

Note 2. If the actual horizontal-space between adjacent cables is more than double of the outer diameter, no correction factor is necessary.

Note 3. For a system consisting of multicore cables, the number of circuits have to be considered. The correction factor has to be applied to the ampacity of the two or three current carrying conductors in the cables.

Note 4. If the grouping of single core cables consists of n loaded single core cables, the correction factor shall be determinate for n/2 or n/3 circuits depending on the number of current-carrying conductors.

Tabella B.9i. Fattori di correzione per circuiti di cavi unipolari installati in canaline
 Table B.9i. Correction factors for single-core cables' circuits installed in cable trays

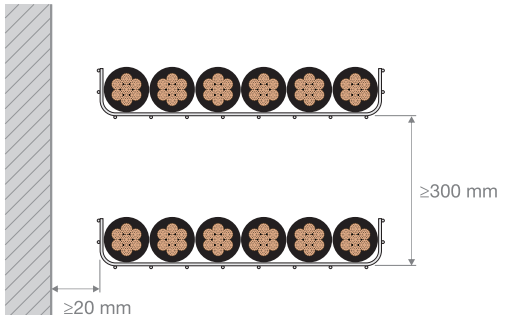
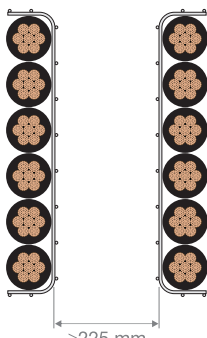
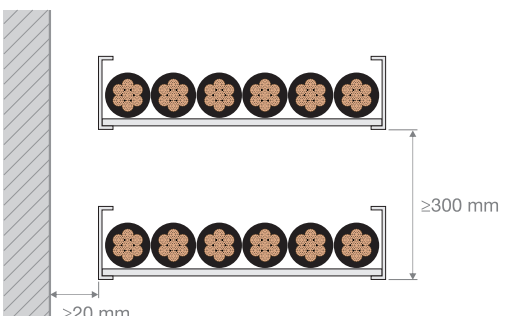
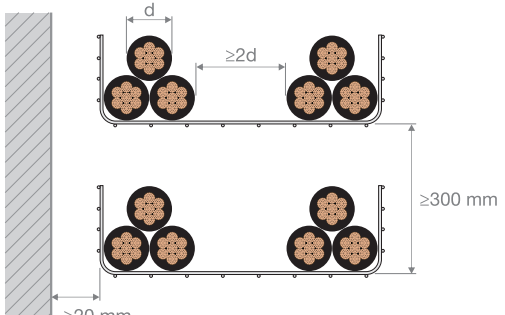
Metodo di installazione <i>Installation method</i>	Numero di canaline <i>Number of cable trays</i>	Numero di circuiti trifase costituiti da cavi unipolari <i>Number of three-phase circuits of single-core cables</i>		
		1	2	3
		Fattore di correzione <i>Correction factor</i>		
Singolo strato in contatto tra loro e posa in canaline ventilate disposte orizzontalmente. <i>Single layer in touch between each other in ventilated cable trays in a horizontal plane arrangement.</i> 	1	0,98	0,91	0,87
	2	0,96	0,87	0,81
	3	0,95	0,85	0,78
Singolo strato in contatto tra loro e posa in canaline ventilate disposte verticalmente. <i>Single layer between each other in ventilated cable trays in a vertical plane arrangement.</i> 	1	0,96	0,86	-
	2	0,95	0,84	-
Singolo strato in contatto tra loro e posa in canaline a scaletta disposte orizzontalmente. <i>Single layer between each other in cable ladders in a horizontal plane arrangement.</i> 	1	1,00	0,97	0,96
	2	0,98	0,93	0,89
	3	0,97	0,90	0,86
Configurazione a triangolo e posa in canaline ventilate disposte orizzontalmente. <i>Delta configuration in ventilated cable trays in a horizontal plane arrangement.</i> 	1	1,00	0,98	0,96
	2	0,97	0,93	0,89
	3	0,96	0,92	0,86

Metodo di installazione <i>Installation method</i>	Numero di canaline <i>Number of cable trays</i>	Numero di circuiti trifase costituiti da cavi unipolari <i>Number of three-phase circuits of single-core cables</i>		
		1	2	3
		Fattore di correzione <i>Correction factor</i>		
<p>Configurazione a triangolo e posa in canaline ventilate disposte verticalmente. <i>Delta configuration in ventilated cable trays in a vertical plane arrangement.</i></p> 	1	1,00	0,91	0,89
2	1,00	0,90	0,86	
<p>Configurazione a triangolo e posa in canaline a scaletta disposte orizzontalmente. <i>Delta configuration in cable ladders in a horizontal plane arrangement.</i></p> 	1	1,00	1,00	1,00
2	0,97	0,95	0,93	
3	0,96	0,94	0,90	

Tabella B.9I. Fattori di correzione per cavi multipolari installati in canaline
 Table B.9I. Correction factors for multicore cables installed in cable trays

Metodo di installazione <i>Installation method</i>	Numero di canaline <i>Number of cable trays</i>	Numero di cavi multipolari <i>Number of multicore cables</i>					
		1	2	3	4	6	9
		Fattore di correzione <i>Correction factor</i>					
Singolo strato in contatto tra loro e posa in canaline ventilate disposte orizzontalmente. <i>Single layer in touch between each other in ventilated cable trays in a horizontal plane arrangement.</i> 	1	1,00	0,88	0,82	0,79	0,76	0,73
	2	1,00	0,87	0,80	0,77	0,73	0,68
	3	1,00	0,86	0,79	0,76	0,71	0,66
	6	1,00	0,84	0,77	0,73	0,68	0,64
Singolo strato ad una distanza pari al valore del diametro esterno "d" e posa in canaline ventilate disposte orizzontalmente. <i>Single layer with a clearance equal to the external diameter "d" in ventilated cable trays in a horizontal plane arrangement.</i> 	1	1,00	1,00	0,98	0,95	0,91	-
	2	1,00	0,99	0,96	0,92	0,87	-
	3	1,00	0,98	0,95	0,91	0,85	-
Singolo strato in contatto tra loro e posa in canaline ventilate disposta verticalmente. <i>Single layer between each other in ventilated cable trays in a vertical plane arrangement.</i> 	1	1,00	0,88	0,82	0,78	0,73	0,72
	2	1,00	0,88	0,81	0,76	0,71	0,70

Metodo di installazione <i>Installation method</i>	Numero di canaline <i>Number of cable trays</i>	Numero di cavi multipolari <i>Number of multicore cables</i>					
		1	2	3	4	6	9
		Fattore di correzione <i>Correction factor</i>					
<p>Singolo strato ad una distanza pari al valore del diametro esterno "d" e posa in canaline ventilate disposta verticalmente. <i>Single layer with a clearance equal to the external diameter "d" in ventilated cable trays in a vertical plane arrangement.</i></p> 	1	1,00	0,91	0,89	0,88	0,87	-
<p>Singolo strato in contatto tra loro e posa in canaline a scaletta disposta orizzontalmente. <i>Single layer between each other in cable ladders in a horizontal plane arrangement.</i></p> 	1	1,00	0,87	0,82	0,80	0,79	0,78
	2	1,00	0,86	0,81	0,78	0,76	0,73
	3	1,00	0,85	0,79	0,76	0,73	0,70
	6	1,00	0,83	0,76	0,73	0,69	0,66
<p>Singolo strato ad una distanza pari al valore del diametro esterno "d" e posa in canaline a scaletta disposta orizzontalmente. <i>Single layer with a clearance equal to the external diameter "d" in cable ladders in a horizontal plane arrangement.</i></p> 	1	1,00	1,00	1,00	1,00	1,00	-
	2	1,00	0,99	0,98	0,97	0,96	-
	3	1,00	0,98	0,97	0,96	0,93	-

Appendice C. Spazi di cablaggio all'interno dei quadri elettrici

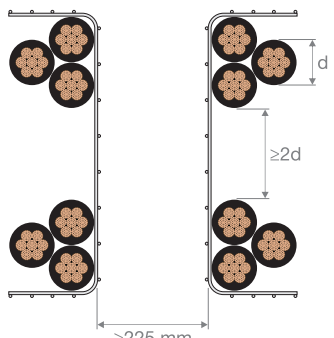
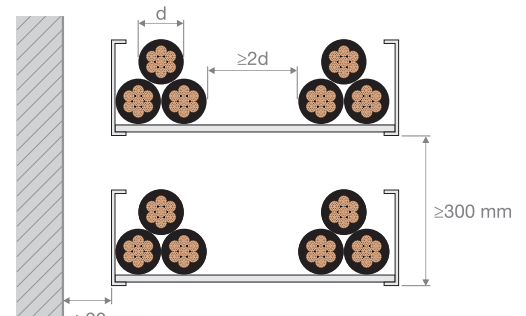
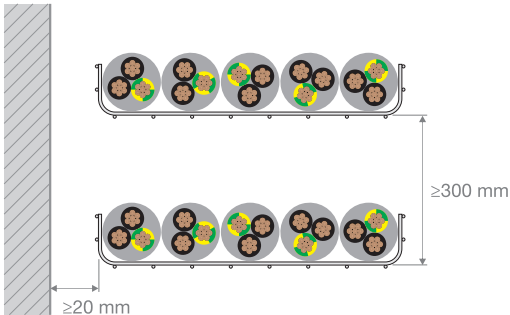
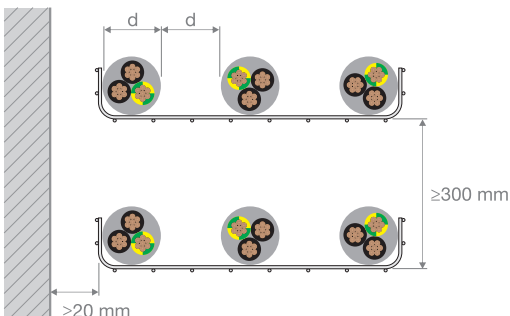
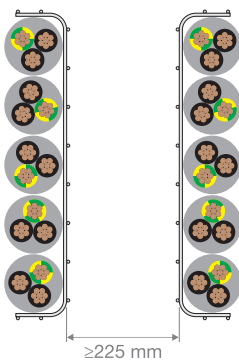
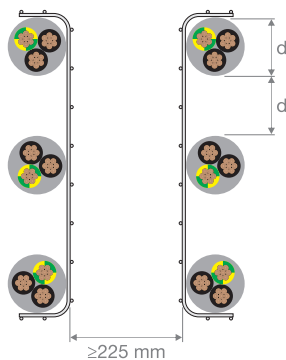
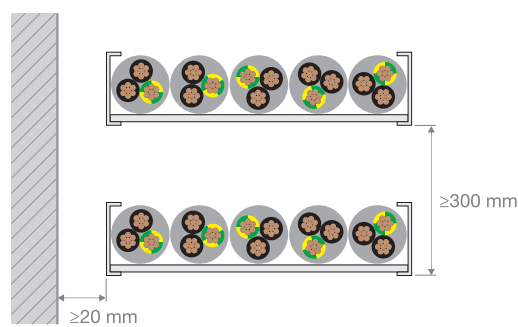
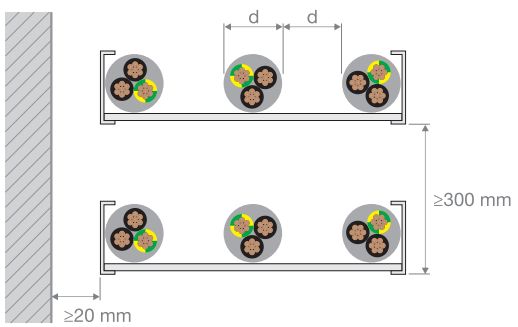
Appendix C. Wire bending space at filed wiring terminals

Tabella C.1. Spazi minimi per il cablaggio interno ai quadri elettrici secondo UL 508a – Rev. 2007-2018 (25 Wire Bending Space)

Table C.1. Minimum bending space, terminal to wall, according to UL 508a – Rev. 2007-2018 (25 Wire Bending Space)

Sezione del conduttore Wire Size		Spazio minimo di cablaggio d*							
[AWG/kcmil]	[mm ²]	1 conduttore 1 wire		2 conduttori 2 wires		3 conduttori 3 wires		4 o più conduttori 4 or more wires	
		Non specificato Not specified		**		**		**	
14 ÷ 10 AWG	2,1 ÷ 5,3			**		**		**	
8 ÷ 6	8,4 ÷ 13,3	1-1/2	38	**		**		**	
4 ÷ 3	21,2 ÷ 26,7	2	51	**		**		**	
2	33,6	2-1/2	64	**		**		**	
1	42,4	3	76	**		**		**	
1/0	53,5	5	127	5	127	7	178	n.a.	
2/0	67,4	6	152	6	152	7-1/2	191	n.a.	
3/0	85	7	178	7	178	8	203	n.a.	
4/0	107,2	7	178	7	178	8-1/2	216	n.a.	
250 kcmil	127	8	203	8	203	9	229	10	254
300	152	10	254	10	254	11	279	12	305
350	177	12	305	12	305	13	330	14	356
400	203	12	305	12	305	14	356	15	381
500	253	12	305	12	305	15	381	16	406
600	304	14	356	16	406	18	457	19	483
700	355	14	356	16	406	20	508	22	559
750 ÷ 800	380 ÷ 405	18	457	19	483	22	559	24	610
900	456	18	457	19	483	24	610	24	610
1000	506	20	508	n.a.		n.a.		n.a.	
1250	633	22	559	n.a.		n.a.		n.a.	
1500 ÷ 2000	760 ÷ 1013	24	610	n.a.		n.a.		n.a.	

* È la distanza tra il terminale di connessione e la parete dell'involucro. Essa è misurata in linea retta a partire dal punto di connessione del terminale e perpendicolarmente alla parete dell'involucro nella direzione verso la quale il conduttore è diretto all'uscita del terminale stesso.

** Conduttori con sezioni inferiori a 1/0 AWG non possono essere cablati in parallelo.

n.a. Valori non disponibili.

* The distance between the end of a pressure wire connector or terminal block for connection of a field installed wire, and the wall of the enclosure toward which the wire is to be directed.

** Conductors smaller than 1/0 AWG shall not be connected in parallel.

n.a. Values not available.



Figura C.1. Definizione dello spazio di cablaggio
Figure C.1. Definition of bending space

Appendice D. Tabelle di assorbimento dei motori

Appendix D. Motors' full-load currents

D.1 Assorbimento dei motori in corrente alternata secondo UL 508a Motors' full-load currents with alternate current according to UL 508a

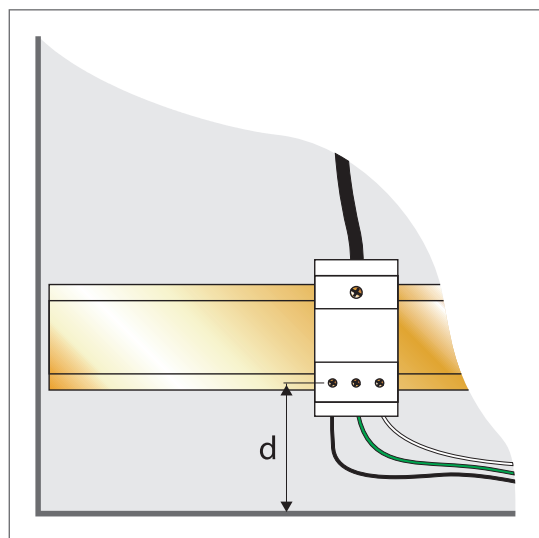
Tabella D.1. Assorbimento dei motori in corrente alternata in funzione della potenza secondo UL 508a – Rev. 2018 (50 Individual Load Ratings)

Table D.1. Motors' full-load currents with alternate current related to the power in according to UL 508a – Rev. 2018 (50 Individual Load Ratings)

Potenza Power [HP]	110 – 120 V		200 V		208 V		220 – 240 V		380 – 415 V		440 – 480 V		550 – 600 V	
	Fasi: 1 Phase: 1	Fasi: 3 Phase: 3	Fasi: 1 Phase: 1	Fasi: 3 Phase: 3	Fasi: 1 Phase: 1	Fasi: 3 Phase: 3	Fasi: 1 Phase: 1	Fasi: 3 Phase: 3	Fasi: 1 Phase: 1	Fasi: 3 Phase: 3	Fasi: 1 Phase: 1	Fasi: 3 Phase: 3	Fasi: 1 Phase: 1	Fasi: 3 Phase: 3
1/10	3,0	–	–	–	–	–	1,5	–	1	–	–	–	–	–
1/8	3,8	–	–	–	–	–	1,9	–	1,2	–	–	–	–	–
1/6	4,4	–	2,5	–	2,4	–	2,2	–	1,4	–	–	–	–	–
1/4	5,8	–	3,3	–	3,2	–	2,9	–	1,8	–	–	–	–	–
1/3	7,2	–	4,1	–	4,0	–	3,6	–	2,3	–	–	–	–	–
1/2	9,8	4,4	5,6	2,5	5,4	2,4	4,9	2,2	3,2	1,3	2,5	1,1	2	0,9
3/4	13,8	6,4	7,9	3,7	7,6	3,5	6,9	3,2	4,5	1,8	3,5	1,6	2,8	1,3
1	16,0	8,4	9,2	4,8	8,8	4,6	8	4,2	5,1	2,3	4	2,1	3,2	1,7
1-1/2	20,0	12	11,5	6,9	11,0	6,6	10	6	6,4	3,3	5	3	4	2,4
2	24,0	13,6	13,8	7,8	13,2	7,5	12	6,8	7,7	4,3	6	3,4	4,8	2,7
3	34,0	19,2	19,6	11,0	18,7	10,6	17	9,6	10,9	6,1	8,5	4,8	6,8	3,9
5	56,0	30,4	32,2	17,5	30,8	16,7	28	15,2	17,9	9,7	14	7,6	11,2	6,1
7-1/2	80,0	44,0	46,0	25,3	44,0	24,2	40	22	27	14	21	11	16	9
10	100,0	56,0	57,5	32,2	55,0	30,8	50	28	33	18	26	14	20	11
15	135,0	84,0	–	48,3	–	46,2	56	42	44	27	34	21	27	17
20	–	108,0	–	62,1	–	59,4	88	54	56	34	44	27	35	22
25	–	136,0	–	78,2	–	74,8	110	68	70	44	55	34	44	27
30	–	160,0	–	92,0	–	88,0	136	80	87	51	68	40	54	32
40	–	208,0	–	120,0	–	114,0	176	104	112	66	88	52	70	41
50	–	260,0	–	150,0	–	143,0	216	130	139	83	108	65	86	52
60	–	–	–	177,0	–	169,0	–	154	–	103	–	77	–	62
75	–	–	–	221,0	–	211,0	–	192	–	128	–	96	–	77
100	–	–	–	285,0	–	273,0	–	248	–	165	–	124	–	99
125	–	–	–	359,0	–	343,0	–	312	–	208	–	156	–	125
150	–	–	–	414,0	–	396,0	–	360	–	240	–	180	–	144
200	–	–	–	552,0	–	528,0	–	480	–	320	–	240	–	192
250	–	–	–	–	–	–	–	604	–	403	–	302	–	242
300	–	–	–	–	–	–	–	722	–	482	–	361	–	289
350	–	–	–	–	–	–	–	828	–	560	–	414	–	336
400	–	–	–	–	–	–	–	954	–	636	–	477	–	382
450	–	–	–	–	–	–	–	1030	–	–	–	515	–	412
500	–	–	–	–	–	–	–	1180	–	786	–	590	–	472

* L'assorbimento per i motori da 265 V e 277 V è determinato riducendo i valori corrispondenti ai motori da 220 – 240 V del 13% e 17% rispettivamente.

* To obtain full-load currents for 265 V and 277 V motors, decrease corresponding 220 – 240 volt ratings by 13% and 17% respectively.

D.2 Assorbimento dei motori in corrente continua secondo UL 508a

Motors' full-load currents with direct current according to UL 508a

Tabella D.2. Assorbimento dei motori in corrente continua in funzione della potenza secondo UL 508a – Rev. 2018 (50 Individual Load Ratings)

Table D.2. Motors' full-load currents with direct current related to the power in according to UL 508a – Rev. 2018 (50 Individual Load Ratings)

Potenza Power [HP]	90 V	110 – 120 V	180 V	220 – 240 V	500 V	550 – 600 V
1/10	–	2,0	–	1,0	–	–
1/8	–	2,2	–	1,1	–	–
1/6	–	2,4	–	1,2	–	–
1/4*	4,0	3,1	2,0	1,6	–	–
1/3	5,2	4,1	2,6	2,0	–	–
1/2	6,8	5,4	3,4	2,7	–	–
3/4	9,6	7,6	4,8	3,8	–	1,6
1	12,2	9,5	6,1	4,7	–	2,0
1-1/2	–	13,2	8,3	6,6	–	2,7
2	–	17,0	10,8	8,5	–	3,6
3	–	25,0	16,0	12,2	–	5,2
5	–	40,0	27,0	20,0	–	8,3
7-1/2	–	58,0	–	29,0	13,6	12,2
10	–	76,0	–	38,0	18,0	16,0
15	–	110,0	–	55,0	27,0	24,0
20	–	148,0	–	72,0	34,0	31,0
25	–	184,0	–	89,0	43,0	38,0
30	–	220,0	–	106,0	51,0	46,0
40	–	292,0	–	140,0	67,0	61,0
50	–	360,0	–	173,0	83,0	75,0
60	–	–	–	206,0	99,0	90,0
75	–	–	–	255,0	123,0	111,0
100	–	–	–	341,0	164,0	148,0
125	–	–	–	425,0	205,0	185,0
150	–	–	–	506,0	246,0	222,0
200	–	–	–	675,0	330,0	294,0

* L'assorbimento di motori da 32 Vdc e potenza di 1/4 HP è di 8,6 A.

* The full-load current for a 1/4 HP, 32 Vdc motor is 8.6 A.

Appendice E. Specifiche dei conduttori per cavi secondo NFPA 70

Appendix E. Conductors for general wiring according to NFPA 70

Nella tabella che segue vengono definite le caratteristiche ed i limiti di impiego dei conduttori per cavi.
 In the table below types and applications for conductors for general wiring are specified.

Tabella E.1. Specifiche dei conduttori per cavi secondo Art. 310 del NFPA 70 (NEC) – Ed. 2020 - Tabella 310.4(A)
 Table E.1. Conductors for general wiring according to Art. 310 of NFPA 70 (NEC) – Ed. 2020 - Table 310.4(A)

Nome commerciale Trade Name	Tipo Type	Massima temperatura di esercizio Maximum operating temperature	Applicazione Application	Insolamento Insulation	Sezione Size [AWG/kcmil]	Copertura esterna Outer Covering
Fluorinated ethylene propylene	FEP or FEPB	90°C	Luoghi asciutti e umidi <i>Dry and damp locations</i>	Fluorinated ethylene propylene	14÷2	None
		200°C	Luoghi asciutti applicazioni speciali <i>Dry locations special applications</i>	Fluorinated ethylene propylene	14÷8 6÷2	Glass braid Glass or other suitable braid material
Mineral insulation (metal sheathed)	MI	90°C	Luoghi asciutti e bagnati <i>Dry and wet locations</i>	Magnesium oxide	18÷500	Copper or alloy steel
		250°C	Applicazioni speciali <i>For special applications</i>			
Moisture-, heat-, and oil-resistant thermoplastic	MTW	60°C	Cablaggio di macchine in luoghi bagnati <i>Machine tool wiring in wet locations</i>	Flame-retardant, moisture-, heat-, and oil-resistant thermoplastic	22÷1000	None or Nylon jacket or equivalent
		90°C	Cablaggio di macchine in luoghi asciutti <i>Machine tool wiring in dry locations</i> Nota informativa: vedere NFPA 79. <i>Informational Note: See NFPA 79.</i>			
Paper		85°C	Per conduttori di servizi sotterranei, o per autorizzazione speciale <i>For underground service conductors, or by special permission</i>	Paper		Lead sheath
Perfluoro-alkoxy	PFA	90°C	Luoghi asciutti e umidi <i>Dry and damp locations</i>	Perfluoro-alkoxy	14÷4/0	None
		200°C	Luoghi asciutti applicazioni speciali <i>Dry locations special applications</i>			
Perfluoro-alkoxy	PFAH	250°C	Solo luoghi asciutti. Solo per conduttori all'interno di apparecchiature o all'interno condotti collegati ad apparecchiature (solo nichel o rame nichelato) <i>Dry locations only. Only for leads within apparatus or within raceways connected to apparatus (nickel or nickel-coated copper only)</i>	Perfluoro-alkoxy	14÷4/0	None
Thermoset	RHH	90°C	Luoghi asciutti e umidi <i>Dry and damp locations</i>		14÷2000	Moisture-resistant, flame-retardant, nonme- tallic covering
Moisture-resistant thermoset	RHW	75°C	Luoghi asciutti e bagnati <i>Dry and wet locations</i>	Flame-retardant, moisture-resistant thermoset	14÷2000	Moisture-resistant, flame-retardant, nonme- tallic covering
	RHW-2	90°C				

Nome commerciale Trade Name	Tipo Type	Massima temperatura di esercizio Maximum operating temperature	Applicazione Application	Insolamento Insulation	Sezione Size [AWG/kcmil]	Copertura esterna Outer Covering
Silicone	SA	90°C	Luoghi asciutti e umidi <i>Dry and damp locations</i>	Silicone rubber	14÷2000	Glass or other suitable braid material
		200°C	Per applicazioni speciali <i>For special application</i>			
Thermoset	SIS	90°C	Pannelli di comando e controllo a bassa ed alta tensione. <i>Switchboard and switchgear wiring only</i>	Flame-retardant thermoset	14÷4/0	None
Thermoplastic and fibrous outer braid	TBS	90°C	Pannelli di comando e controllo a bassa ed alta tensione. <i>Switchboard and switchgear wiring only</i>	Thermoplastic	14÷4/0	Flame-retardant, nonmetallic covering
Extended polytetra- fluoro-ethylene	TFE	250°C	Solo luoghi asciutti. Solo per conduttori all'interno di apparecchiature o all'interno condotti collegati ad apparecchiature (solo nichel o rame nichelato) <i>Dry locations only. Only for leads within apparatus or within raceways connected to apparatus, or as open wiring (nickel or nickel-coated copper only)</i>	Extruded polytetra-fluoro- ethylene	14÷4/0	None
Heat-resistant thermoplastic	THHN	90°C	Luoghi asciutti e umidi <i>Dry and damp locations</i>	Flame-retardant, heat- resistant thermoplastic	14÷1000	Nylon jacket or equivalent
Moisture- and heat- resistant thermoplastic	THHW	75°C	Luoghi umidi <i>Wet location</i>	Flame-retardant, moi- sture- and heat-resistant thermoplastic	14÷2000	None
		90°C	Luoghi asciutti <i>Dry location</i>			
Moisture- and heat- resistant thermoplastic	THW	75°C	Luoghi asciutti e bagnati <i>Dry and wet locations</i>	Flame-retardant, moisture- and heat-resistant thermoplastic	14÷2000	None
		90°C	Applicazioni speciali in apparecchiature di illuminazione a scarica elettrica. Limitati a 1000V a circuito aperto o inferiore (Dimensioni solo 14÷8 come permesso da 410.68) <i>Special applications within electric discharge lighting equipment. Limited to 1000 open-circuit volts or less. (Size 14-8 only as permitted in 410.68.)</i>			
	THW-2	90°C	Luoghi asciutti e bagnati <i>Dry and wet locations</i>			
Moisture- and heat- resistant thermoplastic	THWN	75°C	Luoghi asciutti e bagnati <i>Dry and wet locations</i>	Flame-retardant, moisture- and heat-resistant thermoplasti	14÷1000	Nylon jacket or equivalent
		90°C				
Moisture-resistant thermoplastic	TW	60°C	Luoghi asciutti e bagnati <i>Dry and wet locations</i>	Flame-retardant, moisture- resistant thermoplastic	14÷2000	None
Underground feeder and branch-circuit cable - single conductor (for Type UF cable employing more than one conduc- tor, see Article 340).	UF	60°C	Vedi articolo 340. <i>See Article 340.</i>	Moisture-resistant	14÷4/0	Integral with insulation
		75°C		Moisture- and heat-resistant		

Nome commerciale <i>Trade Name</i>	Tipo <i>Type</i>	Massima temperatura di esercizio <i>Maximum operating temperature</i>	Applicazione <i>Application</i>	Insolamento <i>Insulation</i>	Sezione Size [AWG/kcmil]	Copertura esterna <i>Outer Covering</i>
Underground service- entrance cable - single conductor (for Type USE cable employing more than one conductor, see Article 338).	USE	75°C	Vedi articolo 338. <i>See Article 338.</i>	Heat- and moisture-resistant	14÷2000	Moisture-resistant nonmetallic covering (See 338.2.)
	USE-2	90°C	Luoghi asciutti e bagnati <i>Dry and wet locations</i>			
Thermoset	XHH	90°C	Luoghi asciutti e umidi <i>Dry and damp locations</i>	Flame-retardant thermoset	14÷2000	None
Thermoset	XHHN	90°C	Luoghi asciutti e umidi <i>Dry and damp locations</i>	Flame-retardant thermoset	14÷1000	Nylon jacket or equivalent
Moisture-resistant thermoset	XHHW	90°C	Luoghi asciutti e umidi <i>Dry and damp locations</i>	Flame-retardant, moisture- resistant thermoset	14÷2000	None
		75°C	Luoghi bagnati <i>Wet locations</i>			
Moisture-resistant thermoset	XHHW-2	90°C	Luoghi asciutti e bagnati <i>Dry and wet locations</i>	Flame-retardant, moisture- resistant thermoset	14÷2000	None
Moisture-resistant thermoset	XHWN	75°C	Luoghi asciutti e -bagnati <i>Dry and wet locations</i>	Flame-retardant, moisture- resistant thermoset	14÷1000	Nylon jacket or equivalent
	XHWN-2	90°C				
Modified ethylene tetrafluoro-ethylene	Z	90°C	Luoghi asciutti e umidi <i>Dry and damp locations</i>	Modified ethylene tetrafluoro-ethylene	14÷4/0	None
		150°C	Luoghi asciutti applicazioni speciali <i>Dry locations special applications</i>			
Modified ethylene tetrafluoro-ethylene	ZW	75°C	Luoghi bagnati <i>Wet locations</i>	Modified ethylene tetrafluoro- ethylene	14÷2	None
		90°C	Luoghi asciutti e umidi <i>Dry and damp locations</i>			
		150°C	Luoghi asciutti – applicazioni speciali <i>Dry locations — special applications</i>			
	ZW-2	90°C	Luoghi asciutti e bagnati <i>Dry and wet locations</i>			

Appendice F. Specifiche Flexible cords and cables secondo NFPA 70

Appendix F. Flexible cords and cables according to NFPA 70

Nella tabella che segue vengono definite le sigle utilizzate per definire le tipologie dei Flexible cords and cables mentre nella tabella successiva sono definite le caratteristiche ed i limiti di impiego.
In the tables below identification letters for coding and types for Flexible cords and cables are specified.

Tabella F.1. Sigle utilizzate per definire i Flexible cords and cables specificati nell'Art. 400 del NFPA 70 (NEC)

Table F.1. Letters used for Flexible cords and cables coding specified in the Art. 400 of NFPA 70 (NEC)

Tipo Letter	Descrizione Description
E	As first letter: Elevator cable.
E	After first letter: Thermoplastic elastomer insulation.
H	Heater cord.
NI	"Non-integral" used for parallel cords such as Type NISPT-1 to denote insulated conductors and jacket are separate.
O	The jacket is oil resistant.
OO	The jacket and the conductor insulation are oil resistant.
P	Parallel conductor cord.
S	Extra hard usage Flexible Cord.
SJ	Hard usage Flexible Cord.
SV	Not hard usage Flexible Cord.
T	As first letter: Tinsel cord. Single flattened No. 27 AWG conductor wound around insulating core, for very low current, highly flexible application.
T	After first letter: Thermoplastic insulation.
-1, -2, -3	Insulation thickness for parallel cords, thinnest to thickest. Actual insulation thickness varies with cord type and AWG size.
XTW	Parallel cord for decorative lighting strings.
CXTW	Twisted pair cord or single conductor for decorative lighting strings.
W	As last letter: Moisture and sunlight resistant.
W	As the only letter: Portable Power Cable.

Esempi - *Examples*

SOOW – Extra hard usage, jacket and conductor insulation are oil resistant, moisture and sunlight resistant

SJTO – Hard usage, thermoplastic insulation, jacket is oil resistant

Tabella F2. Specifiche dei Flexible cords and cables secondo Art. 400 del NFPA 70 (NEC) - Ed. 2020 - Tabella 400.4
Table F2. Flexible cords and cables according to Art. 400 of NFPA 70 (NEC) - Ed. 2020 - Table 400.4

Descrizione Trade name	Tipo Type	Codice famiglia Family code TEKIMA	Uso Use	Tensione Voltage [V]	Sezione Size [AWG/kcmil]	Numero di conduttori Number of conductors	Materiale dell'isolamento Insulation	Guaina Outer covering
Lamp cord	C	80160	Pendant or portable. Dry locations. Not hard usage.	300 600	18÷16 15÷10	min. 2	Termoindurente o termoplastico Thermoset or thermoplastic	Nessuna None
Elevator cable	E	80170	Elevator lighting and control. Unclassified locations.	300 o 600	20÷2	min. 2	Termoindurente Thermoset	Tre strati di cotone, il più esterno resistente alla fiamma e all'umidità Three cotton, Outer one flame-retardant & moisture-resistant
Elevator cable	E0	80180	Elevator lighting and control. Unclassified locations.	300 o 600	20÷2	min. 2	Termoindurente Thermoset	Tre strati di cotone, il più esterno resistente alla fiamma e all'umidità Three cotton, Outer one flame-retardant & moisture-resistant
Elevator cable	E0	80190	Elevator lighting and control. Hazardous (classified) locations.	300 o 600	20÷2	min. 2	Termoindurente Thermoset	Cotone e guaina in neoprene One cotton and a neoprene jacket.
Elevator cable	ETP	80200	Hazardous (classified) locations.	300 o 600	-	-	-	Termoplastico Thermoplastic
Elevator cable	ETT	80210	Hazardous (classified) locations.	300 o 600	-	-	-	Cotone o equivalente e guaina termoplastica One cotton or equivalent and a thermoplastic jacket
Electric vehicle cable	EV	80220	Electric vehicle charging. Wet location. Extra hard usage.	1000	18÷500	min. 2 plus grounding conductor(s), plus optional hybrid data, signal communications, and optical fiber cables.	Termoindurente con nylon opzionale Thermoset with optional nylon	Termoindurente Thermoset
	EVJ	80230	Electric vehicle charging. Wet location. Hard usage.	300	18÷12	-	-	-
Electric vehicle cable	EVE	80240	Electric vehicle charging. Wet location. Extra hard usage.	1000	18÷500	min. 2 plus grounding conductor(s), plus optional hybrid data, signal communications, and optical fiber cables.	Elastomero termoplastico con nylon opzionale Thermoplastic elastomer with optional nylon	Elastomero termoplastico Thermoplastic elastomer
	EVJE	80250	Electric vehicle charging. Wet location. Hard usage.	300	18÷12	-	-	-
Portable power cable	EVT	80260	Electric vehicle charging. Wet location. Extra hard usage.	1000	18÷500	min. 2 plus grounding conductor(s), plus optional hybrid data, signal communications, and optical fiber cables.	Termoplastico con nylon opzionale Thermoplastic with optional nylon	Termoplastico Thermoplastic
	EVJT	80270	Electric vehicle charging. Wet location. Hard usage.	300	18÷12	-	-	-
Portable power cable	G	80155	Portable and extra hard usage.	2000	12÷500	2÷6 plus grounding conductor(s)	Termoindurente Thermoset	Termoindurente, oil-resistant Oil-resistant thermoset
	G-GC	80150	Portable and extra hard usage.	2000	12÷500	3÷6 plus grounding conductors and 1 ground check conductor	Termoindurente Thermoset	Termoindurente, oil-resistant Oil-resistant thermoset
Heater cord	HPD	80280	Portable heaters. Dry locations. Not hard usage.	300	18÷12	2, 3 or 4	Termoindurente Thermoset	Cotone o rayon Cotton or rayon

Descrizione Trade name	Tipo Type	Codice famiglia Family code TEKIMA	Usò Use	Tensione Voltage [V]	Sezione Size [AWG/kcmil]	Numero di conduttori Number of conductors	Materiale dell'isolamento Insulation	Guaina Outer covering
Parallel heater cord	HPN	80290	Portable. Damp locations. Not hard usage.	300	18÷12	2 or 3	Termoindurente, oil-resistant Oil-resistant thermoset	Termoindurente, oil-resistant Oil-resistant thermoset
	HSJ	80300		300	18÷12		Termoindurente Thermoset	Cotone e termoindurente Cotton and thermoset
Thermoset jacketed heater cords	HSJO	80310	Portable or portable heater. Damp locations. Hard usage.	300	18÷12	2, 3 or 4	Termoindurente Thermoset	Cotone e termoindurente, oil-resistant Cotton and oil-resistant thermoset
	HSJ00	80320		300	18÷12		Termoindurente, oil-resistant Oil-resistant thermoset	
Nonintegral parallel cords	NISP-1	80330		300	20÷18		Termoindurente Thermoset	Termoindurente Thermoset
	NISP-2	80340		300	18÷16			
	NISPE-1	80350	Pendant or portable. Damp locations.	300	20÷18	2 or 3	Elastomero termoplastico Thermoplastic elastomer	Elastomero termoplastico Thermoplastic elastomer
	NISPE-2	80360	Not hard usage.	300	18÷16			
	NISPT-1	80370		300	20÷18		Termoplastico Thermoplastic	Termoplastico Thermoplastic
	NISPT-2	80380		300	18÷16			
Twisted portable cord	PD	80390	Pendant or portable. Dry locations. Not hard usage.	300	18÷16	min. 2	Termoindurente o termoplastico Thermoset or thermoplastic	Cotone o rayon Cotton or rayon
				600	14÷10			
Portable power cable	PPE	80400	Portable, extra hard usage.	2000	12÷500	1÷6 plus optional grounding conductor(s)	Elastomero termoplastico Thermoplastic elastomer	Elastomero termoplastico, oil- resistant Oil-resistant thermoplastic elastomer
Hard service cord	S	80010	Pendant or portable. Damp locations. Extra hard usage.	600	18÷12	min. 2	Termoindurente Thermoset	Termoindurente Thermoset
	SC	80410		600			Termoindurente Thermoset	Termoindurente Thermoset
Flexible stage and lighting power cable	SCE	80420	Portable, extra hard usage.	600	8÷250	min. 1	Elastomero termoplastico Thermoplastic elastomer	Elastomero termoplastico Thermoplastic elastomer
	SCT	80430		600			Termoplastico Thermoplastic	Termoplastico Thermoplastic
Hard service cord	SE	80440	Pendant or portable. Damp locations. Extra hard usage.	600				Elastomero termoplastico Thermoplastic elastomer
	SEW	80450	Pendant or portable. Damp locations and wet locations. Extra hard usage.	600			Elastomero termoplastico Thermoplastic elastomer	
	SEO	80460	Pendant or portable. Damp locations. Extra hard usage	600				Elastomero termoplastico oil resistant Oil-resistant thermoplastic elastomer
	SEOW	80470	Pendant or portable. Damp locations and wet locations. Extra hard usage.	600	18÷2	min. 2		
	SE00	80480	Pendant or portable. Damp locations. Extra hard usage.	600			Elastomero termoplastico oil resistant Oil-resistant thermoplastic elastomer	
	SE00W	80490	Pendant or portable. Damp locations and wet locations. Extra hard usage.	600				

Descrizione Trade name	Tipo Type	Codice famiglia Family code TEKIMA	Usò Use	Tensione Voltage [V]	Sezione Size [AWG/kcmil]	Numero di conduttori Number of conductors	Materiale dell'isolamento Insulation	Guaina Outer covering
	SJ	80020	Pendant or portable. Damp locations.	300			Termoindurente Thermoset	Termoindurente Thermoset
	SJE	80500	Hard usage.	300				
	SJEW	80510	Pendant or portable. Damp and wet locations.	300			Elastomero termoplastico Thermoplastic elastomer	Elastomero termoplastico Thermoplastic elastomer
	SJEO	80520	Pendant or portable. Damp locations.	300				
	SJEW	80530	Pendant or portable. Damp and wet locations.	300				
	SJEO	80540	Pendant or portable. Damp locations.	300			Elastomero termoplastico, oil-resistant Oil-resistant thermoplastic elastomer	Elastomero termoplastico, oil-resistant Oil-resistant thermoplastic elastomer
	SJEO	80550	Pendant or portable. Damp and wet locations.	300				
	SJO	80030	Pendant or portable. Damp locations.	300			Termoindurente Thermoset	
	SJOW	80560	Pendant or portable. Damp and wet locations.	300	18÷10	2÷6		Termoindurente, oil-resistant Oil-resistant thermoset
	SJO	80570	Pendant or portable. Damp locations.	300				
	SJOW	80140	Pendant or portable. Damp and wet locations.	300			Termoindurente, oil-resistant Oil-resistant thermoset	Termoindurente, oil-resistant Oil-resistant thermoset
	SJT	80050	Pendant or portable. Damp locations.	300				
	SJT	80580	Pendant or portable. Damp and wet locations.	300			Termoplastico Thermoplastic	Termoplastico Thermoplastic
	SJTO	80590	Pendant or portable. Damp locations.	300				
	SJTOW	80060	Pendant or portable. Damp and wet locations.	300				
	SJTOW	80600	Pendant or portable. Damp locations.	300			Termoplastico, oil-resistant Oil-resistant thermoplastic	Termoplastico, oil-resistant Oil-resistant thermoplastic
	SJTOW	80610	Pendant or portable. Damp and wet locations.	300				
	SO	80070	Pendant or portable. Damp locations.	600			Termoindurente Thermoset	
	SOW	80620	Pendant or portable. Damp and wet locations. Extra hard usage.	600				
	SOW	80630	Pendant or portable. Damp locations.	600	18÷2	min. 2	Termoindurente, oil-resistant Oil-resistant thermoset	Termoindurente, oil-resistant Oil-resistant thermoset
	SOW	80120	Pendant or portable. Damp and wet locations. Extra hard usage.	600				
	SP-1	80640	Pendant or portable. Damp locations.	300	20÷18			
	SP-2	80650	Not hard usage.	300	18÷16	2 or 3	Termoindurente Thermoset	Nessuna None
	SP-3	80660	Refrigerators, room air conditioners, and as permitted in 422.16(B). Damp locations. Not hard usage.	300	18÷10			

Descrizione <i>Trade name</i>	Tipo <i>Type</i>	Codice famiglia <i>Family code</i> TEKIMA	Uso <i>Use</i>	Tensione <i>Voltage [V]</i>	Sezione <i>Size [AWG/kcmil]</i>	Numero di conduttori <i>Number of conductors</i>	Materiale dell'isolamento <i>Insulation</i>	Guaina <i>Outer covering</i>
All elastomer (thermoplastic) parallel cord	SPE-1	80670	Pendant or portable. Damp locations. Not hard usage.	300	20÷18			
	SPE-2	80680	Refrigerators, room air conditioners, and as permitted in 422.16(B). Damp locations. Not hard usage.	300	18÷16	2 or 3	Elastomero termoplastico <i>Thermoplastic elastomer</i>	Nessuna <i>None</i>
	SPE-3	80690		300	18÷10			
All plastic parallel cord	SPT-1	80700	Pendant or portable. Damp locations. Not hard usage.	300	20÷18	2 or 3		
	SPT-1W	80710	Pendant or portable. Damp and wet locations. Not hard usage.	300		2		
	SPT-2	80720	Pendant or portable. Damp locations. Not hard usage.	300	18÷16	2 or 3	Termoplastico <i>Thermoplastic</i>	Nessuna <i>None</i>
Range, dryer cable	SPT-2W	80730	Pendant or portable. Damp and wet locations. Not hard usage.	300		2		
	SPT-3	80740	Refrigerators, room air conditioners, and as permitted in 422.16(B). Damp locations. Not hard usage.	300	18÷10	2 or 3		
	SFD	80750		300	10÷4	3 or 4	Termoindurente <i>Thermoset</i>	Termoindurente <i>Thermoset</i>
Hard service cord	SRDE	80760	Portable. Damp locations. Ranges, dryers.	300	10÷4	3 or 4	Elastomero termoplastico <i>Thermoplastic elastomer</i>	Elastomero termoplastico <i>Thermoplastic elastomer</i>
	SRDT	80770		300	10÷4	3 or 4	Termoplastico <i>Thermoplastic</i>	Termoplastico <i>Thermoplastic</i>
	ST	80780	Pendant or portable. Damp locations. Extra hard usage.	600				Termoplastico <i>Thermoplastic</i>
Hard service cord	STW	80790	Pendant or portable. Damp and wet locations. Extra hard usage.	600			Termoplastico <i>Thermoplastic</i>	
	STO	80800	Pendant or portable. Damp locations. Extra hard usage.	600	18÷2	min. 2		
	STOW	80080	Pendant or portable. Damp and wet locations. Extra hard usage.	600				Termoplastico, oil-resistant <i>Oil-resistant thermoplastic</i>
	STOO	80810	Pendant or portable. Damp locations. Extra hard usage.	600				
	STOOW	80820	Pendant or portable. Damp and wet locations. Extra hard usage.	600				Termoplastico, oil-resistant <i>Oil-resistant thermoplastic</i>

Descrizione <i>Trade name</i>	Tipo <i>Type</i>	Codice famiglia <i>Family code</i> TEKIMA	Uso <i>Use</i>	Tensione <i>Voltage [V]</i>	Sezione <i>Size [AWG/kcmil]</i>	Numero di conduttori <i>Number of conductors</i>	Materiale dell'isolamento <i>Insulation</i>	Guaina <i>Outer covering</i>
Vacuum cleaner cord	SV	80090		300			Termoindurente <i>Thermoset</i>	Termoindurente <i>Thermoset</i>
	SVE	80830		300			Elastomero termoplastico <i>Thermoplastic elastomer</i>	Elastomero termoplastico <i>Thermoplastic elastomer</i>
	SVEO	80840		300			Elastomero termoplastico, oil-resistant <i>Oil-resistant thermoplastic elastomer</i>	Elastomero termoplastico, oil-resistant <i>Oil-resistant thermoplastic elastomer</i>
	SV0	80850	Pendant or portable. Damp locations. Not hard usage.	300	18÷16	2 0 3	Termoindurente <i>Thermoset</i>	Termoindurente, oil-resistant <i>Oil-resistant thermoset</i>
	SVE00	80860		300			Termoindurente, oil-resistant <i>Oil-resistant thermoset</i>	Termoindurente, oil-resistant <i>Oil-resistant thermoset</i>
	SV00	80870		300			Termoplastico <i>Thermoplastic</i>	Termoplastico <i>Thermoplastic</i>
	SVT	80100		300			Termoplastico <i>Thermoplastic</i>	Termoplastico <i>Thermoplastic</i>
	SVT0	80880		300			Termoplastico, oil-resistant <i>Oil-resistant thermoplastic</i>	Termoplastico, oil-resistant <i>Oil-resistant thermoplastic</i>
SVT00	80890		300					
Parallel tinsel cord	TPT	80900	Attached to an appliance. Damp locations. Not hard usage.	300	27	2	Termoplastico <i>Thermoplastic</i>	Termoplastico <i>Thermoplastic</i>
Jacketed tinsel cord	TST	80910	Attached to an appliance. Damp locations. Not hard usage.	300	27	2	Termoplastico <i>Thermoplastic</i>	Termoplastico <i>Thermoplastic</i>
Portable power- cable	W	80130	Portable, extra hard usage.	2000	12÷500	1÷6	Termoindurente <i>Thermoset</i>	Termoindurente, oil-resistant <i>Oil-resistant thermoset</i>
					501÷1000	1	Termoindurente <i>Thermoset</i>	Termoindurente, oil-resistant <i>Oil-resistant thermoset</i>

Appendice G. Marcatura di cavi e conduttori secondo UL

Appendix G. Wires and cables marking according to UL

Note utilizzate nella Tabella G.1

Notes used in Table G.1

- (A) CCN è il Category Control Number così come definito da UL.
- (B) Si intende il marchio UL Listed ("UL" nel cerchio): R = richiesto sul prodotto, O = opzionale, P = proibito sul prodotto.
- (C) E' la temperatura di impiego quando il conduttore o il cavo è esposto all'acqua o all'umidità.
- (3) Flexible Cords aventi resistenza all'acqua hanno la lettera "W" nella sigla di designazione (esempio: SJTW) possono integrare la marcatura con "water resistant" oppure "water resistant 60°C".
- (4) Conduttori o cavi che sono stati esaminati per il range di temperature marcato sul prodotto, sull'etichetta, sulla bobina o sul contenitore.
- (6) Cavi adatti ad ambienti umidi sono marcati "WET-LOCATIONS CABLE" oppure "WET_LOCS CABLE". Cavi contenenti conduttori adatti ad ambienti umidi possono non essere marcati.
- (7) Temperatura di 250°C per applicazioni speciali in luoghi dove le condizioni ambientali richiedono temperature operative superiori ai 90°C. Le temperature operative per i raccordi sono limitate a 85°C in ambienti asciutti e a 60°C in ambienti umidi.
- (8) Conduttori o cavi adatti per ambienti umidi sono marcati "60°C WET" oppure "75°C WET".
- (9) La temperatura di impiego può essere indicata sul prodotto mediante dei filamenti colorati posizionati sotto l'isolamento o il separatore.
- (10) Il cavo è marcato con range di temperature predefinite o con un codice identificativo di tali range (esempio: marcatura "60°C dry 60°C wet" oppure marcatura con codice "BC-1W1").
- (12) Temperatura di 90°C per ambienti umidi. Temperatura di 150°C in ambienti asciutti per applicazioni speciali dove le condizioni ambientali richiedono temperature operative dei conduttori superiori a 90°C.
- (13) Temperatura di 200°C in ambienti asciutti per applicazioni speciali.
- (14) Il range di temperature del cavo è marcato sul cavo stesso o è definito dal tipo di conduttore presente nel cavo.
- (15) Indica il range minimo di temperatura. È possibile l'impiego a temperature più alte se tali temperature sono marcate sul cavo. Temperature più alte (oltre ai 60°C) sono applicabili solo per applicazioni in ambienti asciutti.
- (16) Il voltaggio può essere di 600 V quando viene utilizzato un isolamento di 45 mil.
- (17) Il cavo adatto in ambienti umidi è marcato "wet" o "wet location".
- (22) Il tipo di cavo indica l'idoneità all'uso in accordo con l'articolo appropriato del NEC con riferimento alle limitazioni di tensione e potenza.
- (24) La tensione di impiego è indicata nella sigla di designazione mediante un suffisso, "-1" specifica 300V, "-2" specifica 600V.
- (27) Alcuni Mineral-Insulated cable possono essere marcati 300 V per usi in Classe 1 remote control and signaling circuits non eccedenti 300 V.
- (30) Un prodotto adatto per impieghi all'esterno è caratterizzato dalla lettera "W" nella sigla di designazione (esempio: SJTW).
- (32) Il cavo adatto per impieghi all'esterno è marcato "outdoor" oppure "outdoor use".
- (33) Il cavo adatto ad impieghi all'esterno è marcato "SUNLIGHT RESISTANT" oppure "SUN. RES." unitamente a "60°C WET" o "75°C WET".
- (35) Un prodotto adatto ad impieghi caratterizzati da esposizione ai raggi solari è marcato "SUNLIGHT RESISTANT", "SUN. RES." oppure "SR."
- (40) Quanto un cavo è adatto all'uso in canaline aperte (cable trays), il prodotto è marcato "for cable tray use", "for CT use" oppure "for use in cable trays."
- (45) Un prodotto valutato resistente agli olii a 60°C è marcato "OIL RESISTANT I", "OIL RES I", "OIL RESISTANT" oppure "PR1.". Un prodotto valutato resistente agli olii a 75°C è marcato "OIL RESISTANT II", "OIL RES II" oppure "PR2."
- (46) Un prodotto valutato resistente agli olii e alla benzina a 60°C è marcato "GASOLINE AND OIL RESISTANT I" oppure "GR1.". Un prodotto valutato resistente agli olii e alla benzina a 75°C è marcato "GASOLINE AND OIL RESISTANT II" oppure "GR2."
- (47) Quando un conduttore isolato è valutato resistente alla sola benzina è marcato "GASOLINE RESISTANT". Se la marcatura appare sulla guaina esterna del cavo, "GASOLINE RESISTANT" è seguito da "CDRS", "CONDS" oppure "CONDUCTORS".
- (50) Quando il prodotto è adatto all'uso interrato è marcato "FOR DIRECT BURIAL", "DIRECT BURIAL", "DIR BUR" oppure "DIR BURIAL".
- (51) Quando adatto all'applicazione per pompe sommerse il prodotto è marcato "PUMP CABLE" oppure "SUBMERSIBLE PUMP CABLE".
- (70) La sigla "OO" indica che sia la guaina che l'isolamento sono resistenti agli olii. La sigla "O" indica che la sola guaina è resistente agli olii.

- (A) CCN is the Category Control Number as defined by UL.
- (B) Indicates whether the UL Mark ("UL" in a circle) is required (R), optional (O) or prohibited (P) on the product.
- (C) Temperature rating for the wire and cable when exposed to water or moisture such as in wet and damp locations.
- (3) Flexible Cords evaluated for water resistance have a "W" in the Type designation, i.e. Type SJTW. The terms "water resistant" or "water resistant 60°C" may also be marked in addition to the "W" designation.
- (4) The wire or cable has been investigated for the temperature rating marked on the product, tag, reel or smallest unit container.
- (6) Cable evaluated for wet-location use is marked "WET-LOCATIONS CABLE" or "WET-LOCS CABLE.". Cable containing conductors evaluated for wet-location use may be marked, but such marking is not required.
- (7) 250°C for special applications in locations where environmental conditions require operation at above 90°C temperature. Temperatures of fittings are limited to 85°C in dry locations and 60°C in wet locations.
- (8) Wire or cable evaluated for wet-location use is marked "60°C WET" or "75°C WET".
- (9) Temperature rating may be indicated on the product by colored marker threads located under either the insulation or separator.
- (10) The cable is marked with predefined temperature ratings or codes (example: marking with temperature rating "60°C dry 60°C wet" or marking with code "BC-1W1").
- (12) 90°C dry and damp location. 150°C dry locations for special applications in locations where environmental conditions require maximum conductor operating temperature ranges above 90°C.
- (13) 200°C in dry locations for special applications.
- (14) The temperature rating of the cable is the rating marked on the cable or implied by the conductor type in the cable.
- (15) Indicates minimum temperature rating. Suitable for use at higher temperatures if marked on the cable or cord. The higher temperatures (above 60°C) only apply to dry applications.
- (16) May be rated 600 volts when employing 45-mil insulation.
- (17) Cable evaluated for wet location use is marked "wet" or "wet location".
- (22) Type designation indicates suitability for use in accordance with the appropriate NEC Article, with respect to voltage and power limitations.
- (24) Rating is indicated by number in the Type designations, "-1" defines 300V, "-2" defines 600V.
- (27) Some Mineral-Insulated cable may be rated 300V for use in Class 1 remote control and signaling circuits not exceeding 300V.
- (30) A product evaluated for outdoor use has a "W" in its Type designation (example: SJTW).
- (32) Cable evaluated for outdoor use is marked "outdoor" or "outdoor use".
- (33) Cable evaluated for outdoor use is marked "SUNLIGHT RESISTANT" or "SUN. RES." plus "60°C WET" or "75°C WET".
- (35) A product evaluated for sunlight resistance is marked "SUNLIGHT RESISTANT", "SUN. RES.", or "SR."
- (40) When evaluated for use in cable trays, the product is marked "for cable tray use," "for CT use" or "for use in cable trays".
- (45) A product evaluated for 60°C oil resistance is marked "OIL RESISTANT I", "OIL RES I", "OIL RESISTANT", or "PR1". A product evaluated for 75°C oil resistance is marked "OIL RESISTANT II", "OIL RES II", or "PR2".
- (46) A product evaluated for 60°C oil resistance and for gasoline resistance is marked "GASOLINE AND OIL RESISTANT I", or "GR1". Similarly, for 75°C oil and for gasoline resistance, the product is marked "GASOLINE AND OIL RESISTANT II" or "GR2".
- (47) When evaluated for gasoline resistance only, the insulated conductors are marked "GASOLINE RESISTANT". If this marking appears on the outer covering of the cable, "GASOLINE RESISTANT" is followed by "CDRS," "CONDS" or "CONDUCTORS".
- (50) When evaluated for direct burial use, the product is marked "FOR DIRECT BURIAL," "DIRECT BURIAL," "DIR BUR" or "DIR BURIAL".
- (51) When evaluated, the product is marked "PUMP CABLE" or "SUBMERSIBLE PUMP CABLE".
- (70) "OO" indicates oil resistant insulation and jacket. "O" indicates oil resistant jacket only.

Tabella G.1. Marcatura di cavi e conduttori secondo UL
Table G.1. Wires and cables marking according to UL

Caratteristica <i>Characteristic</i>	Tipo <i>Type</i>	Articolo del NEC <i>NEC article</i>	CCN ^(A) <i>CCN^(A)</i>	Marchio UL ^(B) <i>UL Mark^(B)</i>	Temperatura in ambiente asciutto <i>Temperature Dry [°C]</i>	Temperatura in ambiente umido ^(C) <i>Temperature Wet^(C) [°C]</i>	Tensione Voltage [V]	Impiego all'esterno <i>Outdoor use</i>	Resistenza alla luce solare <i>Sunlight Resistance</i>	Impiego in canaline aperte <i>Cable Tray Use</i>	Resistente agli oli <i>Oil Resistance</i>	Resistente alla benzina <i>Gasoline Resistance</i>	Interra- mento <i>Direct Burial</i>	Impiego per pompe sommese <i>Submersible Pump Use</i>
Isol. termoindurente <i>Thermoset insulation</i>	RHH	310	ZKST	R	90	-	600/2000	-	(35)	(40)	(45)	(46)	-	-
Isol. termoindurente <i>Thermoset insulation</i>	RHW	310	ZKST	R	75	75	600/2000	-	(35)	(40)	(45)	(46)	-	(51)
Isol. termoindurente <i>Thermoset insulation</i>	RHW	310	ZKST	R	90	90	600/2000	-	(35)	(40)	(45)	(46)	-	(51)
Isol. termoindurente <i>Thermoset insulation</i>	RHW-2	310	ZKST	R	90 ⁽¹³⁾	-	600	-	-	(40)	-	-	-	-
Isol. termoindurente <i>Thermoset insulation</i>	SA, SF	310	ZKST	O	90	-	600	-	-	-	-	-	-	-
Isol. termoindurente <i>Thermoset insulation</i>	SIS	310	ZKST	R	90	-	600	-	(35)	(40)	(45)	(46)	-	-
Isol. termoindurente <i>Thermoset insulation</i>	XHH	310	ZKST	R	90	75	600	-	(35)	(40)	(45)	(46)	-	(51)
Isol. termoindurente <i>Thermoset insulation</i>	XHHW	310	ZKST	R	90	90	600	-	(35)	(40)	(45)	(46)	-	(51)
Isol. termoindurente <i>Thermoset insulation</i>	XHHW-2	310	ZKST	R	90	-	600	-	-	-	-	-	-	-
Isol. termoplastico <i>Thermoplastic insulation</i>	FEP, FEPB	310	ZLGR	R	90 ⁽¹³⁾	-	600	-	-	-	-	-	-	-
Isol. termoplastico <i>Thermoplastic insulation</i>	PFA	310	ZLGR	R	90 ⁽¹³⁾	-	600	-	-	-	-	-	-	-
Isol. termoplastico <i>Thermoplastic insulation</i>	PFAH	310	ZLGR	R	250	-	600	-	-	-	-	-	-	-
Isol. termoplastico <i>Thermoplastic insulation</i>	TBS	310	ZLGR	O	90	-	600	-	-	-	-	-	-	-
Isol. termoplastico <i>Thermoplastic insulation</i>	TFE	310	ZLGR	R	250	-	600	-	-	-	-	-	-	-
Isol. termoplastico <i>Thermoplastic insulation</i>	THHN	310	ZLGR	R	90	-	600	-	(35)	(40)	(45)	-	-	-
Isol. termoplastico <i>Thermoplastic insulation</i>	THHW	310	ZLGR	R	90	75	600	-	(35)	(40)	(45)	-	-	(51)
Isol. termoplastico <i>Thermoplastic insulation</i>	THW	310	ZLGR	R	75	75	600	-	(35)	(40)	(45)	-	-	(51)
Isol. termoplastico <i>Thermoplastic insulation</i>	THW-2	310	ZLGR	R	90	90	600	-	(35)	(40)	(45)	-	-	(51)
Isol. termoplastico <i>Thermoplastic insulation</i>	THWN	310	ZLGR	R	75	75	600	-	(35)	(40)	(45)	(46)	-	(51)
Isol. termoplastico <i>Thermoplastic insulation</i>	THWN-2	310	ZLGR	R	90	90	600	-	(35)	(40)	(45)	(46)	-	(51)
Isol. termoplastico <i>Thermoplastic insulation</i>	TW	310	ZLGR	R	60	60	600	-	(35)	(40)	(45)	(46)	-	(51)

BUILDING WIRES

Caratteristica <i>Characteristic</i>	Tipo <i>Type</i>	Articolo del NEC <i>NEC article</i>	CCN ⁽⁴⁾ <i>CCN⁽⁴⁾</i>	Marchio UL ⁽⁶⁾ <i>UL Mark⁽⁶⁾</i>	Temperatura in ambiente asciutto <i>Temperature Dry [°C]</i>	Temperatura in ambiente umido ⁽⁶⁾ <i>Temperature Wet⁽⁶⁾ [°C]</i>	Tensione Voltage [V]	Impiego all'esterno <i>Outdoor use</i>	Resistenza alla luce solare <i>Sunlight Resistance</i>	Impiego in canaline aperte <i>Cable Tray Use</i>	Resistente agli oli <i>Oil Resistance</i>	Resistente alla benzina <i>Gasoline Resistance</i>	Interra- mento <i>Direct Burial</i>	Impiego per pompe sommese <i>Submersible Pump Use</i>
Isol. termoplastico <i>Thermoplastic insulation</i>	Z	310	ZLGR	R	90 ⁽¹²⁾	-	600	-	-	-	-	-	-	-
Isol. termoplastico <i>Thermoplastic insulation</i>	ZW	310	ZLGR	R	90 ⁽¹²⁾	75	600	-	(35)	-	-	-	-	(51)
Armato <i>Armored</i>	ACTH	320	AWEZ	O	75	-	600	-	-	(40)	-	-	-	-
Armato <i>Armored</i>	ACHH, ACTHH	320	AWEZ	O	90	-	600	-	-	-	-	-	-	-
Piatto <i>Flat cable</i>	FC	322	GOKT	R	75 ⁽³⁾	-	300	-	-	-	-	-	-	-
Conduttore piatto <i>Flat conductor</i>	FCC	324	IKKT	R	(4)	-	300/600	-	-	-	-	-	-	-
Instrumentation Tray Cable <i>Instrumentation Tray Cable</i>	ITC	727	NYTT	R	(4)	(17)	(2)	-	SI - Yes	SI - Yes	-	-	(50)	-
Metal-Clad	MC	330	PJAZ	R	(14)	(6)	600 / 2000	SI - Yes	SI - Yes	SI - Yes	SI - Yes	SI - Yes	SI - Yes	-
Metal-Clad Hazardous Location	MC-HL	330	PJPP	R	(14)	(6)	600 / 2000	SI - Yes	SI - Yes	SI - Yes	SI - Yes	SI - Yes	SI - Yes	-
Mineral Insulated Metal Sheathed Cable	MI	332	PPKV	O	90 ⁽⁷⁾	90 ⁽⁷⁾	600 ⁽²⁷⁾	SI - Yes	(35)	(40)	SI - Yes	SI - Yes	SI - Yes	-
Power and Control Tray Cable	TC	336	QPOR	R	(14)	(6)	600 / 2000	-	(35)	SI - Yes	(45)	(46)	(50)	-
Flexible Cords	C, PD	400	ZJCZ	R	(4)	-	300 ⁽¹⁶⁾	-	-	-	-	-	-	-
Flexible Cords	E, ETP, ETT	400	ZJCZ	R	(4)	-	300	-	-	-	-	-	-	-
Flexible Cords	E0	400	ZJCZ	R	(4)	-	300	-	-	-	SI - Yes	-	-	-
Flexible Cords	HPD	400	ZJCZ	R	(4)	-	300	-	-	-	-	-	-	-
Flexible Cords	HPN	400	ZJCZ	R	(4)	-	300	-	-	-	SI - Yes	-	-	-
Flexible Cords	HS, HSJ	400	ZJCZ	R	(4)	-	300	-	-	-	-	-	-	-
Flexible Cords	HSO, HSJO	400	ZJCZ	R	(4)	-	300	-	-	-	SI - Yes	-	-	-
Flexible Cords	NISP-1, NISP-2	400	ZJCZ	R	(4)	-	300	-	-	-	-	-	-	-
Flexible Cords	NISPE-1, NISPE-2	400	ZJCZ	R	(4)	-	300	-	-	-	-	-	-	-
Flexible Cords	NISPT-1, NISPT-2	400	ZJCZ	R	(4)	-	300	-	-	-	-	-	-	-
Flexible Cords	S, ST	400	ZJCZ	R	(4)	(3)	600	(30)	-	-	-	-	-	-
Flexible Cords	SE	400	ZJCZ	R	(4)	(3)	600	(30)	-	-	-	-	-	-

LOW VOLTAGE CABLES, FLEXIBLE CORD AND FIXTURE CABLES

BUILDING CABLES

BUILDING WIRES

Caratteristica Characteristic	Tipo Type	Articolo del NEC NEC article	CCN ^(A) CCN ^(A)	Marchio UL ^(B) UL Mark ^(B)	Temperatura in ambiente asciutto Temperature Dry [°C]	Temperatura in ambiente umido ^(C) Temperature Wet ^(C) [°C]	Tensione Voltage [V]	Impiego all'esterno Outdoor use	Resistenza alla luce solare Sunlight Resistance	Impiego in canaline aperte Cable Tray Use	Resistente agli olii Oil Resistance	Resistente alla benzina Gasoline Resistance	Interra- mento Direct Burial	Impiego per pompe sommese Submersible Pump Use
Flexible Cords	SEO	400	ZJ CZ	R	(4)	(3)	600	(30)	-	-	Si - Yes	-	-	-
Flexible Cords	SJ, SJT	400	ZJ CZ	R	(4)	(3)	300	(30)	-	-	-	-	-	-
Flexible Cords	SJE	400	ZJ CZ	R	(4)	(3)	300	(30)	-	-	-	-	-	-
Flexible Cords	SJEO	400	ZJ CZ	R	(4)	(3)	300	(30)	-	-	Si - Yes	-	-	-
Flexible Cords	SJO, SJO0, SJTO, SJTO0	400	ZJ CZ	R	(4)	(3)	300	(30)	-	-	Si - Yes ⁽⁷⁰⁾	-	-	-
Flexible Cords	SO, SO0, STO, STO0	400	ZJ CZ	R	(4)	(3)	600	(30)	-	-	Si - Yes ⁽⁷⁰⁾	-	-	-
Flexible Cords	SP-1, SP-2, SP- 3, SRD, SRDT	400	ZJ CZ	R	(4)	-	300	-	-	-	-	-	-	-
Flexible Cords	SPE-1, SPE-2, SPE-3, SRDE	400	ZJ CZ	R	(4)	-	300	-	-	-	-	-	-	-
Flexible Cords	SPT-1, SPT-2, SPT-3	400	ZJ CZ	R	(4)	-	600	(30)	-	-	-	-	-	-
Flexible Cords	SV, SVT	400	ZJ CZ	R	(4)	-	300	-	-	-	-	-	-	-
Flexible Cords	SVE	400	ZJ CZ	R	(4)	-	300	-	-	-	-	-	-	-
Flexible Cords	SVE0	400	ZJ CZ	R	(4)	-	300	-	-	-	Si - Yes	-	-	-
Flexible Cords	SVO, SVO0, SVTO, SVTO0	400	ZJ CZ	R	(4)	-	300	-	-	-	Si - Yes ⁽⁷⁰⁾	-	-	-
Flexible Cords	TPT, TS, TST	400	ZJ CZ	R	(4)	-	300	-	-	-	-	-	-	-
Fixture Wire	KF-1, KF- 2, KFF-1, KFF-2	402	ZIPR	O	200 ⁽⁹⁾	-	(24)	-	-	-	-	-	-	-
Fixture Wire	PAF	402	ZIPR	R	250 ⁽⁹⁾	-	600	-	-	-	-	-	-	-
Fixture Wire	PAFF	402	ZIPR	R	150 ⁽⁹⁾	-	600	-	-	-	-	-	-	-
Fixture Wire	PF, PGF	402	ZIPR	O	200 ⁽⁹⁾	-	600	-	-	-	-	-	-	-
Fixture Wire	PFF, PGFF	402	ZIPR	O	150 ⁽⁹⁾	-	600	-	-	-	-	-	-	-
Fixture Wire	PTF	402	ZIPR	R	250	-	600	-	-	-	-	-	-	-
Fixture Wire	PTFF	402	ZIPR	R	150	-	600	-	-	-	-	-	-	-
Fixture Wire	RFH-2, FFH-2	402	ZIPR	O	75 ⁽⁹⁾	-	600	-	-	-	-	-	-	-

LOW VOLTAGE CABLES, FLEXIBLE CORD AND FIXTURE CABLES

Caratteristica <i>Characteristic</i>	Tipo <i>Type</i>	Articolo del NEC <i>NEC article</i>	CCN ^(A) <i>CCN^(A)</i>	Marchio UL ^(B) <i>UL Mark^(B)</i>	Temperatura in ambiente asciutto <i>Temperature Dry [°C]</i>	Temperatura in ambiente umido ^(C) <i>Temperature Wet^(C) [°C]</i>	Tensione Voltage [V]	Impiego all'esterno <i>Outdoor use</i>	Resistenza alla luce solare <i>Sunlight Resistance</i>	Impiego in canaline aperte <i>Cable Tray Use</i>	Resistente agli oli <i>Oil Resistance</i>	Resistente alla benzina <i>Gasoline Resistance</i>	Interra- mento <i>Direct Burial</i>	Impiego per pompe sommese <i>Submersible Pump Use</i>
Fixture Wire	SF-1, SF-2	402	ZIPR	0	200 ^(B)	-	^(2A)	-	-	-	-	-	-	-
Fixture Wire	SFF-1, SFF-2	402	ZIPR	0	150 ^(B)	-	^(2A)	-	-	-	-	-	-	-
Fixture Wire	TF, TFF	402	ZIPR	R	60	-	600	-	-	-	⁽⁴⁵⁾	⁽⁴⁶⁾	-	-
Fixture Wire	RFHH-2, RFHH-3	402	ZIPR	R	90 ^(B)	-	600	-	-	-	-	-	-	-
Fixture Wire	TFN, TFFN	402	ZIPR	R	90 ^(B)	-	600	-	-	-	⁽⁴⁵⁾	⁽⁴⁶⁾	-	-
Fixture Wire	XF, XFF	402	ZIPR	R	150 ^(B)	-	300	-	-	-	-	-	-	-
Fixture Wire	ZF, ZFF	402	ZIPR	R	150 ^(B)	-	600	-	-	-	-	-	-	-
Fixture Wire	ZHF	402	ZIPR	R	200 ^(B)	-	600	-	-	-	-	-	-	-
Boat Cable	-	-	BDFX	R	⁽¹⁰⁾	-	⁽²⁵⁾	-	-	-	-	⁽⁴⁵⁾	-	-
Bus Drop Cable	-	368	ZIMX	R	60 ⁽¹⁵⁾	⁽⁸⁾	600	⁽³²⁾	-	-	⁽⁴⁵⁾	-	-	-
Festoon Cable	-	610	ZIPF	R	60 ⁽¹⁵⁾	-	600	⁽³²⁾	-	-	⁽⁴⁵⁾	-	-	-
Flexible Motor Supply Cable	-	-	ZJFH	R	90	-	1000/2000	-	⁽³⁵⁾	Si - Yes	⁽⁴⁵⁾	⁽⁴⁷⁾	⁽⁵⁰⁾	-
Heat-Resistant Wire	TGT, TGS, TMGT, KGS, KGT, TGGT, ITFL	-	ZNNA	0	⁽⁴⁾	-	300	-	⁽³⁵⁾	⁽⁴⁰⁾	Si - Yes	⁽⁴⁶⁾	-	-
Machine Tool Wires	MTW	670	ZKHZ	R	90	60	600	-	-	-	-	-	-	-
Pendant Cable	-	610	ZKKA	0	60	-	300/600	⁽³²⁾	-	-	⁽⁴⁵⁾	-	-	-
Photovoltaic Wire	-	690	ZKLA	R	90/150	90	600/2000	Si - Yes	Si - Yes	-	-	-	-	-
Portable Power Cables	W, G, G-GC, PPE	400	QPMU	R	75	⁽⁸⁾	2000	⁽³³⁾	⁽³⁵⁾	-	Si - Yes	-	-	-
Submersible Pump Cable (TPE Insulation)	-	-	ZMHX	R	⁽⁴⁾	60	600	-	-	-	-	-	Si - Yes	-

LOW VOLTAGE CABLES, FLEXIBLE CORD AND FIXTURE CABLES

SPECIAL PURPOSE WIRES AND CABLES

Appendice H. Style, definizione e riferimenti

Appendix H. Style, definition and reference

La costruzione di ogni conduttore è definita da uno "style number" che identifica una scheda contenente gli aspetti costruttivi del conduttore. La scheda include le temperature e le tensioni ammesse, le dimensioni del conduttore ed il materiale, il materiale e lo spessore dell'isolamento, il materiale e lo spessore dell'eventuale guaina, eventuali rivestimenti e schermi, la norma base di riferimento e l'impiego.

Underwriters Laboratories Inc. suddivide gli "style number" in 5 sezioni dalla 1 alla 5 all'interno delle quali suddivide gli Appliance Wiring Material (conduttori x applicazioni di cablaggio). Le sezioni 1 e 2 sono costituite da prodotti realizzati con isolamento e guaina in materiale termoplastico quale il polivinile di coloruro PVC, il polietilene PE, il polipropilene PP, le sezioni 3 e 4 sono costituite da prodotti realizzati in materiale termoindurente quale la gomma, il polietilene reticolato XLPE. La sezione 5 è costituita da prodotti che possono essere unipolari o multipolari e l'isolamento e la guaina possono essere realizzate in materiali composti o con nastri di ricopertura.

The manufacture of each wire is specified by a "style number" identifying a chart with all the manufacturing aspects of the wire. The chart includes the allowed temperatures and voltages, the wiring dimensions and material, the insulation material and thickness, the material and thickness of the possible conduit, possible jackets and shields, the reference standard and the use. Underwriters Laboratories Inc. divides the "style numbers" in 5 sections from 1 to 5. Inside them are classified the Appliance Wiring Materials.

Sections 1 and 2 include products manufactured with insulation and conduit made of a thermoplastic material such as the polyvinyl chloride PVC, the polyethylene PE, the polypropylene PP; sections 3 and 4 include products manufactured with thermosetting material such as the rubber, the cross-linked polyethylene XLPE. Section 5 includes products which can be either single core or multicore, while insulation and conduit can be made of composite materials or with protection bands.

Tabella H.1. Classificazione degli style

Table H.1. Classification of styles

Style	Sezione Size	Tipologia Type
1000 – 1999 e 10000	1	Singolo conduttore, isolamento in materiale termoplastico <i>Single conductor, thermoplastic - insulated wire</i>
2000 – 2999 e 20000	2	Multi-conduttore, isolamento e guaina termoplastica <i>Multi-conductor, thermoplastic - insulated and jacketed wire</i>
3000 – 3999	3	Singolo conduttore, isolamento termoindurente <i>Single conductor, thermosetting - insulated wire</i>
4000 – 4999	4	Multi-conduttore, isolamento e guaina termoindurente <i>Multi-conductor, thermosetting - insulated and jacketed wire</i>
5000 – 5999	5	Singolo conduttore e multi-conduttore speciali <i>Single and multiple conductor specialty items</i>

Di seguito vengono riassunte in tabella le principali caratteristiche costruttive definite nei relativi "style number" dei cavi elettrici trattati nel presente documento.

Here are resumed the main manufacturing characteristics specified in the respective "style numbers" of the electrical cables described in this document.

Tabella H.2. Aspetti costruttivi richiamati dagli style
Table H.2. Manufacturing aspects recalled by the styles

Style	Prodotto Product	Temperatura Tensione Temperature Voltage	Sezione conduttore Isolamento Conductor's section Insulation	Assemblaggio Assembly	Ricopertura Schermo Jacket Shield	Nastratura Guaina Braid Conduit	Impiego Use
1015	PVC Insulated Wire	80°C, 90°C or 105°C 600Vac, 750Vdc	30 AWG ÷ 2000 kcmil. PVC insulation.	-	-	-	Internal Wiring of Appliances; or Internal Wiring of Appliances where exposed to oil at a temperature not exceeding 60°C or 80°C (whichever is applicable). Tags may also indicate the following: 2,500 V peak - for electronic use only.
1284	Thermoplastic (PVC) - Insulated Wire for Appliance Hook-Up Use	105°C 600V	8 AWG ÷ 1000 MCM. Tinned or bare copper. PVC Insulation.	-	-	-	Internal wiring of appliances; or internal wiring of appliances where exposed to oil at a temperature not exceeding 60°C or 80°C (whichever is applicable).
2464	PVC Jacketed Cable	80°C 300 V	- Labeled or complying with manufacturer's AWM Procedure having a minimum rating of 80°C and 300 V	Two or more singles, twisted pairs of groups of twisted singles twisted together or singles or groups of singles may be laid parallel to form flat, oval or round cable. Lay not specified. Barrier layer and/or fillers optional. Manufacturer shall maintain a complete description of each assembly. May use same or mixed AWG size.	Optional	Optional	Internal wiring or external interconnection of electronic equipment (such as desk-type calculators, dictating machines, or x-ray equipment).
2570	PVC Jacketed Cable	80°C 600 or 1000V	40 AWG minimum Labeled or complying with Manufacturer's AWM Procedure having a minimum rating of 80°C, 600 or 1000V.	Consists of two or more conductors, twisted pairs or groups of twisted conductors twisted together. The conductors or groups of conductors may be laid parallel forming a flat, oval or round cable. The lay of the conductors is not specified. A barrier layer and/or fillers are optional. Manufacturer shall maintain a complete description of each assembly. May use same or mixed AWG size.	Optional Optional	PVC, Class 43	External interconnection or internal wiring of electronic equipment.
2587	PVC Jacketed Cable	90°C 600V	40 AWG minimum Labeled or complying with Manufacturer's AWM Procedure having a minimum rating of 90°C, 600V.	Consists of two or more conductors, twisted pairs or groups of twisted conductors twisted together. The conductors or groups of conductors may be laid parallel forming a flat, oval or round cable. The lay of the conductors is not specified. A barrier layer and/or fillers are optional. Manufacturer shall maintain a complete description of each assembly. May use same or mixed AWG size.	Optional: a 6 mil or heavier PVC covering may be extruded over the conductor assembly. Optional	PVC, Class 43	External interconnection or internal wiring of electronic equipment.
2919	Low Voltage Computer Cable	80°C 30V	40 AWG minimum Labeled or complying with Manufacturer's AWM Procedure having a minimum rating of 80°C, 30V.	Consists of two or more conductors, twisted pairs or groups of twisted conductors twisted together. The conductors or groups of conductors may be laid parallel forming a flat, oval or round cable. The lay of the conductors is not specified. A barrier layer and/or fillers are optional. Manufacturer shall maintain a complete description of each assembly. May use same or mixed AWG size.	Optional: a 6 mil or heavier PVC covering may be extruded over the conductor assembly Optional	Optional PVC, Class 43	As internal wiring or external interconnection in Class 2 Circuits of electronic computers and electric business machines.

Style	Prodotto Product	Temperatura Tensione Temperature Voltage	Sezione conduttore Isolamento Conductor's section Insulation	Assemblaggio Assembly	Ricopertura Schermo Jacket Shield	Nastratura Guaina Braid Conduit	Impiego Use
20233	Multi-Conductor Jacketed Cable	80°C	36 AWG minimum. Solid or Stranded.	Two or more individually insulated conductors or groups of insulated conductors cabled together to form a round cable. A flat or oval cable may also be constructed with not more than three rows of single conductors or groups of conductors. The length of lay of the twisted conductors or groups is not specified. Fillers may be used in a cable but are not required. A barrier layer, if employed, may be a fibrous wrap serving, or braid, paper, nylon, oriented polyethylene terephthalate, or thermoplastic-tape wrap. Such a barrier layer would serve to protect the cable during further processing and would be applied immediately over the twisted assembly of individual conductors or groups of conductors.	Optional	Optional	External interconnection of electronic equipment.
		300V	Labeled or complying with manufacturer's AWM Procedure and Having a min rating of 80°C and 300V. The designations of all styles of individual conductors used in making up the cable assembly shall be available.	Optional	Poly-urethane		
20234	Thermoplastic Polyurethane Jacketed Cable	80°C	36 AWG minimum. Solid or stranded	Two or more individually insulated conductors or groups of insulated conductors cabled together to form a round cable. A flat or oval cable may also be constructed with not more than three rows of single conductors or groups of conductors. The length of lay of the twisted conductors or groups is not specified. Fillers may be used in a cable but are not required. A barrier layer, if employed, may be a fibrous wrap serving, or braid; paper; nylon; oriented polyethylene terephthalate; or thermoplastic-tape wrap. Such a barrier layer would serve to protect the cable during further processing and would be applied immediately over the twisted assembly of individual conductors or groups of conductors.	Optional	Optional	External interconnection of electronic equipment.
		600 or 1000V	Labeled or complying with manufacturer's AWM Procedure and having a minimum rating of 80°C and 600V or 1000V respectively.	Optional	Poly-urethane		
20236	Polyurethane Jacketed Cable	80°C	36 AWG minimum. Solid or stranded	Two or more individually insulated conductors or groups of insulated conductors cabled together to form a round cable. A flat or oval cable may also be constructed with not more than three rows of single conductors or groups of conductors. The length of lay of the twisted conductors or groups is not specified. Fillers may be used in a cable but are not required. A barrier layer, if employed, may be a fibrous wrap serving, or braid; paper; nylon; oriented polyethylene terephthalate; or thermoplastic-tape wrap. Such a barrier layer would serve to protect the cable during further processing and would be applied immediately over the twisted assembly of individual conductors or groups of conductors.	Optional: 4 mil or heavier wall of PVC or other thermoplastic covering may be extruded over the conductor assembly or groups of conductors (with or without shields)		Internal wiring or external interconnection of electronic equipment.
		30V	Labeled or complying with manufacturer's AWM Procedure and having a min rating of 80°C and 30V. The designations of all styles of individual conductors used in making up the cable assembly shall be available.	Optional	Poly-urethane		
20554	Polyurethane Jacketed Cable	80°C	40 AWG minimum	Consists of two or more conductors, twisted pairs or groups of twisted conductors twisted together. The conductors or groups of conductors may be laid parallel forming a flat, oval or round cable. The lay of the conductor is not specified. A barrier layer and/or fillers are optional. Manufacturer shall maintain a complete description of each assembly. May use same or mixed AWG size.	Optional: a 6 mil or heavier covering may be extruded over the conductor assembly		Internal wiring of electronic equipment and appliances.
		30V	Labeled or complying with Manufacturer's AWM Procedure having a minimum rating of 80°C, 30V.	Optional	Poly-urethane		
20886	PVC Jacketed Cable	80°C, 90°C or 105°C	40 AWG minimum	Consists of two or more conductors, twisted pairs or groups of twisted conductors twisted together. The conductors or groups of conductors may be laid parallel forming a flat, oval or round cable. The lay of the conductors is not specified. A barrier layer and/or fillers are optional. May use same or mixed AWG size.	Optional: a 6 mil or heavier PVC covering may be extruded over the conductor assembly		External interconnection or internal wiring of electronic equipment.
		1000Vac, 1200Vdc	Labeled or complying with 1000Vac, 1200Vdc and a temperature rating equaling or exceeding the rating of the cable.	Optional	PVC, Class 43		

Appendice I. Nomenclatura dei cavi Ethernet

Appendix I. Ethernet cables' naming

In tabella è riportata la nomenclatura dei cavi Ethernet ed il significato delle sigle impiegate.
The table shows the nomenclature of the Ethernet cables and the meaning of the abbreviations used.

Tabella I.1. Nomenclatura dei cavi Ethernet

Table I.1. Ethernet cables' naming

Nomenclatura <i>Naming</i>	Schermo su cavo <i>Shield on cable</i>	Schermo su coppie <i>Shield on pairs</i>
U/UTP	Nessuno <i>None</i>	Nessuno <i>None</i>
U/FTP	Nessuno <i>None</i>	Schermo a foglio <i>Foil shield</i>
F/UTP	Schermo a foglio <i>Foil shield</i>	Nessuno <i>None</i>
S/UTP	Schermo a treccia <i>Braid shield</i>	Nessuno <i>None</i>
SF/UTP	Schermo a foglio e a treccia <i>Foil and braid shield</i>	Nessuno <i>None</i>
F/FTP	Schermo a foglio <i>Foil shield</i>	Schermo a foglio <i>Foil shield</i>
S/FTP	Schermo a treccia <i>Braid shield</i>	Schermo a foglio <i>Foil shield</i>
SF/FTP	Schermo a foglio e a treccia <i>Foil and braid shield</i>	Schermo a foglio <i>Foil shield</i>

TP = Twisted Pair (coppia twistata)

U = Unshielded (senza schermo)

F = Foiled (schermo a foglio)

S = Shielded (schermo a treccia)

Appendice J. Prodotti Listed o prodotti Recognized

Appendix J. Listed or Recognized products

Nella ricerca quotidiana di componenti da installare negli impianti di automazione, ci si trova molto spesso di fronte a componenti che differiscono tra loro per la tipologia di omologazione. Alcuni prodotti sono classificati come Recognized ed altri come Listed; vediamo di seguito quali sono le differenze.

During the daily research of components to be installed in the automation systems, we often find various components which differ as concerns standard approvals. Some products are classified as "Recognized" and others as "Listed"; here are the differences as follows:

J.1 I prodotti Listed Listed products

Il marchio UL Listed, è sicuramente il marchio più comunemente adottato per le apparecchiature destinate agli utenti finali ma non dimentichiamo che non è l'unico che possiamo trovare sul mercato, ne esistono degli altri quali ad esempio il marchio ETL Listed e CSA Listed che hanno eguale valore dal punto di vista normativo. Se un prodotto riporta questi marchi, significa che esso risponde ai requisiti di sicurezza che sono in primo luogo basati sugli Standards di Sicurezza pubblicati dall'ANSI (American National Standard Institute) ossia l'Istituto Nazionale Americano di normazione che a sua volta recepisce le prescrizioni emesse dai vari enti quali UL, ETL, CSA, NEMA o altri organismi accreditati. Significa inoltre che il prodotto è stato verificato attraverso una serie di test ed analisi eseguite nei laboratori di prova NRTL (National Recognized Testing Laboratories) quali UL, CSA, TUV, ETL che a loro volta sono Istituti riconosciuti dall'OSHA (Occupational Safety and Health Administration) ovvero l'Istituto Nazionale Americano che si occupa di sicurezza negli ambienti di lavoro.

Questo marchio è visibile comunemente su prodotti finiti destinati all'utente utilizzatore e sono prodotti quali elettrodomestici, apparecchiature per computer, forni, rilevatori di fumo e di monossido di carbonio, estintori, giubbotti salvagente, vetri antiproiettile e migliaia di altri prodotti.

Tipici esempi del settore dell'automazione industriale sono i computer industriali, gli azionamenti per motori elettrici, i fusibili ed i portafusibili oppure le guaine flessibili metalliche ed i relativi raccordi destinate alla protezione di cavi per il collegamento dei motori o di apparecchiature in genere. Oppure ancora i tray cable che sono cavi realizzati per le connessioni tra le canaline posa cavi (cable tray) e l'apparecchiatura; sono, in sostanza, tutti prodotti il cui impiego o la destinazione d'uso è ben specificata da normative di riferimento.

Il marchio UL Listed su un prodotto è riconoscibile attraverso un elemento fondamentale: il marchio circolare UL ed il nome del produttore, il nome commerciale o un numero che identifica il produttore e possono essere seguiti da altri due elementi: la parola "LISTED" in lettere maiuscole e il nome del prodotto (es. "lampada portatile", "portafusibile", ecc.).

Il marchio UL Listed preceduto dalla lettera "C" indica che il prodotto è specifico per il mercato Canadese. I prodotti con questo tipo di marchio sono stati valutati e verificati secondo i requisiti di sicurezza Canadesi che possono essere, per alcuni aspetti, diversi da quelli adattati negli Stati Uniti.

Il marchio UL Listed preceduto dalla lettera "C" e seguito dalla sigla "US" indica la conformità del prodotto sia ai requisiti normativi Canadesi che a quelli degli Stati Uniti. Una struttura di marchi simile è emessa dall'istituto di certificazione canadese CSA.

UL Listed mark is for sure the most commonly used mark for the equipment assigned to final users, but it is not the only one available on the market. There are other marks such as ETL Listed and CSA Listed, having the same value from the normative point of view. If a product has one of these marks, it means that it complies with the safety requirements based on the Safety Standards published by ANSI (American National Standard Institute), that is, the American national standard institute which acknowledges, in its turn, the rules of various institutes such as UL, ETL, CSA, NEMA or other reliable authorities. Furthermore, it means that the product has been verified through a series of tests and analysis carried out at NRTL (National Recognized Testing Laboratories) laboratories, such as UL, CSA, TUV, ETL, which are institutes recognized by OSHA (Occupational Safety and Health Administration), the American national institute dealing with safety at work. This mark can be seen usually on finished products addressed to the users, such as electric household appliances, equipment for computers, ovens, smoke and carbon monoxide alarms, fire extinguishers, life jackets, bullet-proof glass and thousands of other products.

Typical examples of products belonging to the industrial automation sector are the industrial computers, the actuators for electrical motors, fuses and fuseholders, or the flexible metal conduits and pertinent fittings intended to protect the cables for the connection of motors or equipment. Besides, there are tray cables, which are cables made for the connection of cable trays with the equipment; they are all products whose use is specified by reference standards.

The UL Listed mark on a product can be recognized through a fundamental feature: the round UL mark and the name of the manufacturer, the trade name or a number identifying the manufacturer, which can be followed by other two elements: the "LISTED" word in capital letters and the name of the product (e.g. "portable lamp", "fuseholders", etc.).

UL Listed mark with before a "C" letter, means that the product is specific for the Canadian market. Products with this kind of mark have been evaluated and tested in compliance with the Canadian safety requirements which, in some respects, can differ from the ones applied in the United States.

UL Listed mark with before a "C" letter and the "US" abbreviation after, indicates the product compliance with both Canadian and United States requirements.

A similar marking structure is issued by the Canadian certification institute CSA.



J.2 I prodotti Recognized

Recognized products

Il marchio UL Recognized è un marchio che l'utente finale difficilmente vede poiché è utilizzato specificatamente per i componenti che costituiscono gli elementi base di prodotti o sistemi più ampi. Questi componenti, proprio perché componenti di base, possono avere delle restrizioni sulle loro funzionalità o possono essere incompleti nella loro costruzione. Essi differiscono nella sostanza dai prodotti Listed perché riportano sempre nella loro stessa certificazione, una "condizione di accettabilità"; significa che la loro idoneità dipende dall'impiego che il costruttore ne fa, da come egli, ad esempio, li dimensiona rispetto al sistema nel quale vengono inseriti.

Questo marchio si trova su numerosissimi prodotti quali alimentatori, interruttori, circuiti stampati e alcune tipologie di attrezzature industriali di controllo e numerosi altri prodotti. Un esempio tipico è quello dei cavi unipolari style 1015/1284 per il cablaggio interno delle apparecchiature o di alcune lampade di illuminazione; prodotti la cui destinazione d'uso non è definita da norme di riferimento e il cui impiego copre un ventaglio piuttosto ampio di possibilità.

Anche nel caso del prodotto Recognized, il marchio UL Recognized è riconoscibile attraverso un elemento fondamentale: il marchio UR, il nome del produttore, il nome commerciale o un numero che identifica il produttore.

I prodotti destinati al mercato Canadese riportano il marchio UL Recognized preceduto dalla lettera "C". Anche per il marchio UL Recognized vi è la possibilità della conformità contemporanea ai requisiti Canadesi e degli Stati Uniti, in questo caso il marchio è preceduto dalla lettera "C" e seguito dalla sigla "US".

Una struttura di marchi simile è emessa dall'istituto di certificazione canadese CSA.

The UL Recognized mark can be hardly seen by the user, as it is used in particular for components being the basic elements of greater products or systems. Being basic components, they can have restricted functional characters or incomplete structure. They differ from the Listed products for the fact that in their own standard a "condition of acceptability" is always reported: that means, that their suitability depends on how the manufacturer uses them, for instance how he measures them as regards the system they are inserted in.

This mark can be found on several products such as feeders, switches, printed circuits and some types of industrial control equipment and other numerous products. A typical example is the one of the single core cables style 1015/1284 for the internal wire harness of equipment or lamps; they are products whose destination is not specified by reference standards and their use covers a wide range of possibilities.

Also in case of a Recognized product, the UL Recognized mark can be recognized through some fundamental elements: the UR mark, the name of the manufacturer, the trade name or a number identifying the manufacturer.

The products for the Canadian markets show the UL Recognized mark with a "C" letter before. Also for the UL Recognized mark there is the possibility of a simultaneous compliance with the Canadian and the United States requirements, and in this case the mark has a "C" letter before and a "US" abbreviation after.

A similar marking structure is issued by the Canadian certification institute CSA.



J.3 Differenza fra prodotti Listed e prodotti Recognized

Difference between Listed products and Recognized products

Come esempio si consideri una vasca idromassaggio; se si individua una etichetta con il marchio UL Listed e le altre informazioni definite precedentemente, allora la vasca idromassaggio, che è il prodotto finale, risponde ai requisiti stabiliti dalla norma UL 1563, Electric Spas, Equipment Assemblies and Associated Equipment.

Se invece non si individua il marchio UL Listed sul prodotto, da una analisi più attenta, si potrebbe rilevare che alcuni componenti della vasca idromassaggio, come la pompa, il sistema di controllo o il filtro hanno il marchio UL Recognized. Alcuni costruttori potrebbero affermare che, poiché i componenti sono UL Recognized, allora il prodotto in cui essi sono installati risponde a tutti i requisiti necessari. Ma questo non sempre è vero poiché il marchio UL Recognized significa che il componente "da solo" risponde ai requisiti per un uso specifico e limitato e solo il marchio UL Listed applicato sul prodotto, in questo caso sulla vasca idromassaggio, indica che il prodotto stesso risponde ai requisiti di una norma specifica.

In conclusione possiamo affermare che il marchio UL Recognized copre la verifica e la valutazione di componenti che sono incompleti o le cui funzionalità sono ristrette. Essi potrebbero essere idonei se utilizzati come componente di una determinata macchina ma non in una esattamente uguale se installata in una zona a pericolo di esplosione od in una zona per la quale esistono delle norme specifiche che ne regolano l'installazione. Questi componenti saranno utilizzati in prodotti completi o sistemi UL Listed. In ogni caso i prodotti finiti possono sempre essere soggetti a valutazione da parte degli AHJs (Authorities Having Jurisdiction) ovvero gli enti Americani di controllo sulle installazioni. Qualora il prodotto finito sia Listed la verifica si limita alla constatazione della presenza del marchio ed alla correttezza dell'installazione, nel caso in cui il prodotto non sia Listed la verifica può spingersi fino al controllo dell'idoneità di ogni singolo componente rispetto alla funzionalità, alla destinazione d'uso ed all'installazione del prodotto finito.

La distinzione fra componente e prodotto finito è il punto critico tra la certificazione di un componente e la certificazione di un prodotto finito nel quale il componente viene utilizzato. Ritornando all'esempio della vasca idromassaggio, l'uso di componenti UL Recognized all'interno di un prodotto finito non significa ne che il prodotto stesso sia UL Listed, ne che risponda alle norme di riferimento per quel tipo di prodotto.

As an example, see a hydromassage tub: if there is a label with a UL Listed mark on it and all the other previously mentioned information, it means that the hydromassage tub, which is the end product, meets the requirements of UL 1563 standard, Electric Spas, Equipment Assemblies and Associated Equipment.

If, otherwise, the UL Listed mark cannot be found on the product, after a careful consideration, it could be possible to find out that some components of the hydromassage tub, such as the pump, the control system or the filter show the UL Recognized mark. Some manufacturers could say that, as the components are UL Recognized marked, the product they are installed in meets the necessary requirements. This is not always true, because the UL Recognized mark means that the single component meets the requirements for a specific and limited use, and just the UL Listed mark applied on the product, in this case on the hydromassage tub, indicates that the product as a whole meets the standard requirements.

To sum up, we can say that the UL Recognized mark covers the check and evaluation of components which are incomplete or have reduced functionalities. They could be suitable if used as components of a certain machine, but they are unfit if that same machine is installed in a burst hazard location or in a place where the installation must follow specific standards. These components will be used with complete finished products or UL Listed systems. In any case, the finished products can be always subject to evaluation by AHJs (Authorities Having Jurisdiction), that is, the American inspection institutions for installations. When the finished product is Listed, the inspection is limited to recognition of the mark presence and right installation; in case the product is not Listed, the inspection can include also the verification of suitability for each single component as regards functionality, use and installation of the end-item.

The distinction between a component and the end-item is the critical point between the certification of one component and the certification of the end-item, where the component is used. So, going back to the example of the hydromassage tub, the use of UL Recognized components within a end-item does not mean neither that the product is UL Listed, nor that it is in compliance with the reference standard regarding that kind of product.

J.4 L'intercambiabilità dei marchi di certificazione Interchangeable product certification marks

Negli USA e in Canada ci sono numerosi organismi di certificazione indipendenti che operano su standard nazionali e che sono in diretta concorrenza tra loro. Le organizzazioni più note* operanti nel settore elettrico che partecipano alla redazione degli standards, testano i prodotti ed emettono certificati di conformità ed omologazione per gli Stati Uniti ed il Canada sono UL "Underwriters Laboratories Inc." in USA e CSA "Canadian Standards Association" in Canada. Queste due organizzazioni, CSA e UL, hanno siglato un Memorandum of Understanding (ultimo aggiornamento: aprile 2006) che definisce il mutuo riconoscimento dei tests, delle ispezioni e dei certificati emessi in accordo alle norme nord americane (sia USA che Canada).







Questo accordo semplifica il processo di certificazione delle aziende che intendono ottenere marchi di qualità per gli USA e/o il Canada. Se una azienda richiede il marchio CSA o il marchio UL, può richiedere l'omologazione sia a CSA "Canadian Standards Association" che a UL "Underwriters Laboratories Inc."

È importante che questi aspetti di mutuo riconoscimento siano chiari. Il marchio di certificazione fornisce prova visiva che il prodotto è stato testato e certificato in accordo ad una norma specifica e per un determinato mercato. Tutti i prodotti certificati per un mercato specifico (quali, per esempio, le lampade, i cavi TC, i fusibili, ecc.) sono stati testati secondo la stessa norma indipendentemente che riportino il marchio UL oppure CSA. Dalla tabella che segue è chiaro come i marchi UL e CSA siano intercambiabili e, oggi, mutuamente riconosciuti.

In USA and Canada there are several independent organizations working on national standards that are sometimes in direct competition. The most known organizations that are working on electrical standards, product approvals and certifications for the American and Canadian markets are UL "Underwriters Laboratories Inc." in U.S. and CSA "Canadian Standards Association" in Canada. Both companies, CSA and UL signed a Memorandum of Understanding (latest update: April 2006) which defines the mutually acceptance for tests and investigations in accordance to defined standards.*

The Memorandum of Understanding agreement between the two organizations simplifies the certification process for companies who desire U.S. and/or Canadian marks. If a company requires the CSA or the UL mark, it can ask for the approval by the CSA "Canadian Standards Association" or by the UL "Underwriters Laboratories Inc."

It is important to demystify the certification marks. The certification mark provides visual evidence that the product has been tested and certified to meet the applicable standard for a specific market. All products (i.e. the luminaires, the tray cables, the fuses, etc.) certified for a specific market have been tested to the same standard, regardless of whether they carry a UL or CSA mark. Hence, as you can see in the following table, UL and CSA marks are interchangeable and are equally accepted today.

		Mercato di destinazione <i>Market of destination</i>		
		USA	Canada	USA+Canada
Organismo di certificazione <i>Certification organization</i>	UL	 <p>Prodotti con questo marchio sono certificati dall'organismo Americano (UL) per il mercato USA in accordo alle norme presenti in USA.</p> <p><i>Products bearing these marks are certified by American Organization (UL) for the U.S. market according to the applicable U.S. standards.</i></p>	 <p>Prodotti con questo marchio sono certificati dall'organismo Americano (UL) per il mercato Canadese ("c" a sinistra del logo) in accordo alle norme presenti in Canada.</p> <p><i>Products bearing this marks are certified by American Organization (UL) for the Canadian ("c" on the left of the logo) market according to the applicable Canadian standards.</i></p>	 <p>Prodotti con questo marchio sono certificati dall'organismo Americano (UL) per i mercati USA ("us") e Canada ("c") in accordo alle norme presenti in USA e Canada.</p> <p><i>Products bearing this marks are certified by American Organization (UL) for both the U.S. ("us" on the right of the logo) and Canadian ("c" on the left of the logo) markets according to the applicable U.S. and Canadian standards.</i></p>
	CSA	 <p>Prodotti con questo marchio sono certificati dall'organismo Canadese (CSA) per il mercato USA ("us" a destra del logo) in accordo alle norme presenti in USA.</p> <p><i>Products bearing this mark are certified by Canadian Organization (CSA) for the U.S. market ("us" on the right of the logo) according to the applicable U.S. standards.</i></p>	 <p>Prodotti con questo marchio sono certificati dall'organismo Canadese (CSA) per il mercato Canadese in accordo alle norme presenti in Canada.</p> <p><i>Products bearing this mark are certified by Canadian Organization (CSA) for the Canadian market according to the applicable Canadian standards.</i></p>	 <p>Prodotti con questo marchio sono certificati dall'organismo Canadese (CSA) per i mercati USA ("us" a destra del logo) e Canada ("c" a sinistra del logo) in accordo alle norme presenti in USA e in Canada.</p> <p><i>Products bearing this mark are certified by Canadian Organization (CSA) for both the U.S. ("us" on the right of the logo) and Canadian ("c" on the left of the logo) markets according to the applicable U.S. and Canadian standards.</i></p>

Sulla base di quanto esposto in tabella due prodotti (uno certificato da UL e l'altro certificato da CSA) possono essere completamente intercambiabili sia rispetto al marchio di certificazione che rispetto al mercato di destinazione, ciò significa che i requisiti sono garantiti da entrambi i prodotti. Attenzione però che, se si osserva esclusivamente il marchio stampato sul prodotto**, non si può avere informazione immediata dell'applicazione per cui il prodotto stato è stato fabbricato e certificato; è sempre opportuno verificare le caratteristiche tecniche e le prestazioni dichiarate dal produttore.

*Based on the table above two products (one certified by UL and one certified by CSA) can be interchangeable from the certification and market-destination point of view, this means that the standard requirements are guaranteed by both the products. However, remember, if you just look at the visual marks that are on the products** you cannot understand which application they are manufactured for. You always have to check the technical characteristics and the performance declared by the producer.*

Alcune delle domande che ci sono state poste più di frequente:

- 1) Il marchio CSA vale solo per i prodotti destinati al mercato Canadese? No, sebbene il CSA sia spesso percepito come un marchio adatto solo al mercato Canadese, questo organismo di certificazione può testare e omologare prodotti sia per il Canada che per gli USA.
- 2) Un Tray Cable marcato c(UL) può essere usato sul mercato Canadese? Sì, questo prodotto è stato fabbricato in accordo alle norme Canadesi (è identificato dalla "c" presente alla sinistra del marchio UL) ed è certificato dall'organismo Americano UL per essere utilizzato sul mercato Canadese.
- 3) Vedo che le vostre corde unipolari della serie 1060 sono marcate c(UR)us ma ho bisogno di un cavo con marchio CSA perché la mia installazione è in Canada! Il nostro prodotto è fabbricato in accordo alle norme presenti in USA (lo si identifica dalla "us" a destra del logo UR) e in Canada (lo si identifica dalla "c" a sinistra del logo UL) ed è certificato dall'organizzazione Americana UL per essere usato sui mercati USA e Canada.
- 4) Leggo sul vostro catalogo che il prodotto è stato testato in accordo ad una norma UL ma riporta il marchio CSA, come è possibile? Se la norma di riferimento è UL, il marchio non deve essere UL? Gli organismi di certificazione quali UL e CSA si occupano sia della redazione delle norme che dei test. È una convinzione errata quella se la norma riporta il nome dell'organismo allora i test e l'omologazione possano essere fatti solo da quell'organismo. La realtà delle cose è che la pubblicazione delle norme e l'esecuzione dei test sono due attività indipendenti che non sono (e non devono) essere in conflitto di interesse tra loro. Le norme sono a disposizione dei produttori per poter eseguire correttamente i processi di progettazione e fabbricazione ma sono anche a disposizione di tutti gli organismi di certificazione accreditati per eseguire i test. Il produttore può scegliere di far certificare il suo prodotto da uno qualunque degli organismi accreditati.

Some frequently asked questions.

- 1) *Isn't the CSA mark only for Canadian products? No, although CSA is often perceived as only for Canadian products, this organization can test and certify products according for both Canada and USA markets.*
- 2) *Tray Cable marked with the c(UL) mark can be used on the Canadian market? Yes, this product has been produced according to Canadian standards (identified by the "c" on the left of UL) and certified by the American Organization (UL) to be used in the Canadian market.*
- 3) *I understand that your Series 1060 single core cable is marked with the c(UR)us mark but I need a cable marked CSA because my installation is in Canada! Our product has been produced according to both U.S. and Canadian standards (identified by "c" on the left and "us" on the right of UR) and certified by the American Organization (UL) to be used in the U.S. and Canadian market.*
- 4) *I understand that your product has been tested to a UL standard but it carries a CSA mark, how can this be possible? If the standard is UL, doesn't the mark also have to come from UL? Certification organization such as UL and CSA are involved in both standards publication and testing. It is a common misperception that because an organization's name appears on a particular standard, that organization must exclusively perform product testing against the standard. The fact is that the standards publication and testing roles must be performed independently in order to avoid a conflict of interest. The standards are available for the manufacturer's use in design and manufacturing process but are also available to all accredited certification organizations for product testing. The manufacturer can choose to certify his product by any of the certification organizations.*

* Altre organizzazioni (NRTL Nationally Recognized Testing Laboratory) riconosciute dall'OSHA (Occupational Safety and Health Administration) sono QPS, CCL, FM, ETL, MET, NSF, TÜV, etc.

** Non necessariamente il marchio è sul prodotto, potrebbe anche essere sulla confezione, dipende dalla tipologia del prodotto stesso e dai requisiti della norma specifica.

* Other Organizations (NRTL Nationally Recognized Testing Laboratory) recognized by OSHA (Occupational Safety and Health Administration) are QPS, CCL, FM, ETL, MET, NSF, TÜV, etc.

** Not necessarily the mark is printed or stamped on the product, it could also be on the packaging, it depends on the type of product and on the requirements of the specific standard.

Appendice K. I gradi di protezione degli involucri

Appendix K. Degrees of protection provided by enclosures

Di seguito vengono analizzate le normative di riferimento che specificano i gradi di protezione degli involucri per materiali ed apparecchiature elettriche sia per il mercato europeo che per quello nord americano con lo scopo di cercare di chiarire la definizione dei gradi di protezione e una correlazione, se possibile, fra i requisiti europei e quelli americani.

Herewith will be analysed all the reference standards specifying the degrees of protection provided by enclosures for electrical equipment and materials both for the European and for the North American markets, with the aim of clarifying the definition of the degrees of protection and a correlation, if possible, between the European and the American requirements.

K.1 Grado di protezione IP Degree of protection IP

La norma europea EN 60529 e la norma tedesca DIN 40050 Parte 9 costituiscono, in combinazione, un documento esaustivo per quel che riguarda i gradi di protezione degli involucri. L'obiettivo di queste norme è quello di:

- 1) Definire i gradi di protezione degli involucri per apparecchiature elettriche in relazione a:
 - a) Protezione di persone contro il contatto con parti pericolose all'interno degli involucri;
 - b) Protezione delle apparecchiature contenute negli involucri contro l'ingresso di corpi solidi;
 - c) Protezione delle apparecchiature contenute negli involucri contro l'ingresso dannoso dell'acqua.
- 2) Designare e classificare i gradi di protezione.
- 3) Stabilire i requisiti per ciascuna designazione.
- 4) Definire le prove di verifica.

Queste norme classificano i gradi di protezione degli involucri attraverso il codice IP. Il codice IP (International Protection oppure Ingress Protection) è costituito da 4 parti caratteristiche che identificano e caratterizzano il grado di protezione di un involucro.

The European EN 60529 standard and the German DIN 40050 standard, part 9, are, combined, an exhaustive document as concerns the degrees of protection provided by enclosures. The object of this standard is to give:

- 1) Definitions for the degrees of protection provided by enclosures for electrical equipment as regards:
 - a) Protection of persons against contact with hazardous parts inside the enclosures;
 - b) Protection of the equipment inside the enclosures against ingress of solid foreign objects;
 - c) Protection of the equipment inside the enclosures against the harmful effects due to the ingress of water.
- 2) Designations and classification for the degrees of protection
- 3) Requirements for each designation
- 4) Tests to be performed

These Standards classify the degree of protection of the enclosures with the IP code. The IP code (International Protection or Ingress Protection) is made by 4 parts which identify and characterize the degree of protection provided by the enclosure.

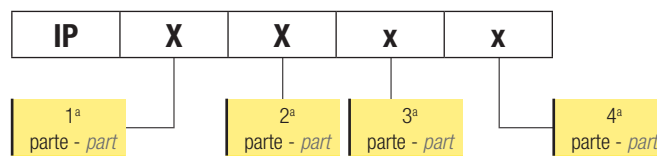

Prima parte, indica la protezione dell'individuo contro la penetrazione di corpi solidi e contro l'accesso anche attraverso attrezzi impugnati da una persona.

First part indicates the protection of the equipment against the ingress of solid foreign objects and the protection against access to hazardous parts also by means of tools in the hands of a person.

Tabella K.1. Definizione della prima parte del codice IP

Table K.1. Definition of the first part of the IP code

Livello Level	Definizione Definition	Effetti Effects
IP0_	Non protetto. <i>Non-protected.</i>	Non protetto. <i>Non-protected.</i>
IP1_	Protetto contro corpi solidi di diametro ≥ 50 mm. <i>Protected against solid foreign objects ≥ 50 mm in diameter.</i>	Protetto contro l'accesso col dorso della mano. <i>Protected against access with the back of hand.</i>
IP2_	Protetto contro corpi solidi di diametro $\geq 12,5$ mm. <i>Protected against solid foreign objects $\geq 12,5$ mm in diameter.</i>	Protetto contro l'accesso con un dito. <i>Protected against access with a finger.</i>
IP3_	Protetto contro corpi solidi di diametro $\geq 2,5$ mm. <i>Protected against solid foreign objects $\geq 2,5$ mm in diameter.</i>	Protetto contro l'accesso con un utensile, per esempio un cacciavite. <i>Protected against access with a tool, for instance with a screwdriver.</i>
IP4_	Protetto contro corpi solidi di diametro ≥ 1 mm. <i>Protected against solid foreign objects ≥ 1 mm in diameter.</i>	Protetto contro l'accesso con un filo. <i>Protected against access with a wire.</i>
IP5_	Protetto parzialmente contro la polvere. La penetrazione non è totalmente esclusa, ma essa non deve inficiare il buon funzionamento dell'apparecchiatura o pregiudicarne la sicurezza. <i>Partially dust-protected. Ingress of dust is not totally prevented, but the dust must not enter in sufficient quantity to interface with satisfactory operation of the equipment or compromise its safety.</i>	Protetto parzialmente contro l'accesso di polvere o di un filo sottile. <i>Ingress of dust is not totally prevented, protected against access with a thin wire.</i>
IP6_	Protetto totalmente contro la polvere. Dust-tight. <i>Protection against ingress of dust.</i>	Totalmente protetto dalla polvere. <i>No ingress of dust, complete protection against contact (dust tight).</i>

Seconda parte, indica il grado di protezione contro gli effetti dannosi sull'apparecchiatura dovuti alla penetrazione di acqua nell'involucro. Se non è prevista protezione contro l'ingresso di acqua la cifra deve essere sostituita dalla lettera X. Questa parte può essere costituita da livelli aggiuntivi presenti nella norma DIN 40050-9.

Second part indicates the degree of protection against the harmful effects due to the ingress of water inside the enclosure. If a protection against the ingress of water is not foreseen, the characteristic numeral must be replaced by letter X. This part may consist of additional levels contained in the DIN 40050-9 standard.

Tabella K.2. Definizione della seconda parte del codice IP

Table K.2. Definition of the second part of the IP code

Livello <i>Level</i>	Definizione <i>Definition</i>	Norma <i>Standard</i>
IP_0	Non protetto. <i>Non-protected.</i>	EN 60529, DIN 40050-9
IP_1	Protetto contro la caduta verticale di gocce d'acqua. <i>Protected against the vertical water dripping.</i>	EN 60529, DIN 40050-9
IP_2	Protetto contro la caduta verticale di gocce d'acqua con inclinazione dell'involucro fino a 15°. <i>Protected against the water dripping when the enclosure is tilted at an angle up to 15°.</i>	EN 60529, DIN 40050-9
IP_3	Protetto contro la pioggia (con inclinazione dell'involucro fino a 60°). <i>Protected against rain (enclosure tilted up to 60°).</i>	EN 60529, DIN 40050-9
IP_4	Protetto contro gli spruzzi d'acqua (acqua spruzzata da tutte le direzioni). <i>Protected against spraying (water sprayed from any direction).</i>	EN 60529, DIN 40050-9
IP_4K	Protetto contro gli spruzzi d'acqua ad alta pressione (da tutte le direzioni). <i>Protected against high-pressure water spray (from any direction).</i>	DIN 40050-9
IP_5	Protetto contro i getti d'acqua (da tutte le direzioni). <i>Protected against water jets (from any direction).</i>	EN 60529, DIN 40050-9
IP_6	Protetto contro i getti d'acqua potenti (da tutte le direzioni). <i>Protected against powerful water jets (from any direction).</i>	EN 60529, DIN 40050-9
IP_6K	Protetto contro i getti d'acqua potenti ad alta pressione (acqua in getto potente da tutte le direzioni). <i>Protected against powerful high-pressure jetting (from any direction).</i>	DIN 40050-9
IP_7	Protetto contro gli effetti dell'immersione temporanea (fino a 1 m). <i>Protected against the effects of temporary immersion (up to 1 m).</i>	EN 60529, DIN 40050-9
IP_8	Protetto contro gli effetti dell'immersione continua (oltre 1 m). <i>Protected against the effects of continuous immersion (beyond 1 m).</i>	EN 60529, DIN 40050-9
IP_9K	Protetto contro getti di lavaggio ad alta pressione o vapore acqueo (da tutte le direzioni). <i>Protected against high-pressure jets or steam (from any direction).</i>	DIN 40050-9

L'integrazione con la norma DIN consente designazioni aggiuntive che permettono di identificare prodotti con elevati standard qualitativi, quali per esempio le guaine plastiche corrugate di protezione per cavi e relativa raccorderia. La prova mediante getto ad alta pressione (circa 80 bar) consente di definire il prodotto conforme al grado di protezione IP 69K (6 = protezione totale contro la polvere e l'accesso mediante un filo, 9K = protezione contro gli effetti dannosi di getti d'acqua di lavaggio ad alta pressione).

The integration with DIN standard allows additional designations which permit to identify the products with high qualitative standards, such as the corrugated plastic conduits for the protection of cables and pertinent fittings. The test with high-pressure jets (about 80 bar) permits to define the product as IP 69K degree of protection (6 = total protection against dust and access with a wire, 9K = Protection against the harmful effects due to the high-pressure jets).

Terza parte, è la prima lettera aggiuntiva ed indica il grado di protezione contro l'accesso umano a parti pericolose. Essa viene utilizzata nel caso in cui la protezione contro l'accesso a parti pericolose da parte delle persone è effettivamente superiore a quella indicata dalla prima parte, quando quindi non vi è corrispondenza tra il grado di protezione delle persone contro l'accesso a parti pericolose e il grado di protezione contro l'ingresso di corpi solidi estranei; oppure quando non è indicato il grado di protezione contro l'ingresso di corpi solidi (quindi la prima parte è sostituita da una X) ma solo il grado di protezione contro l'accesso umano.

Third part is the first additional letter and indicates the degree of protection for persons against the access to hazardous parts. It is used when the protection for persons against access to hazardous parts is higher than the one indicated by the first part, usually when there is no coincidence between the degree of protection for persons and the degree of protection against the ingress of solid foreign objects; when the degree of protection against solid foreign objects is not indicated (the first part is replaced by a X), but only the degree of protection for persons.

Tabella K.3. Definizione della terza parte del codice IP

Table K.3. Definition of the third part of the IP code

Livello <i>Level</i>	Definizione <i>Definition</i>
a	Protetto contro l'accesso col dorso della mano. <i>Protected against access with the back of hand.</i>
b	Protetto contro l'accesso con un dito. <i>Protected against access with a finger.</i>
c	Protetto contro l'accesso con un utensile, per esempio un cacciavite. <i>Protected against access with a tool, for instance with a screwdriver.</i>
d	Protetto contro l'accesso con un filo. <i>Protected against access with a wire.</i>

Quarta parte, dopo la seconda cifra caratteristica o dopo la lettera supplementare, può essere presente una lettera addizionale che fornisce informazioni ulteriori sulla protezione del materiale.
Fourth part, after the second part or after the supplementary letter, an additional letter can be appended to provide further information related to the protection of the device.

Tabella K.4. Definizione della quarta parte del codice IP

Table K.4. Definition of the fourth part of the IP code

Livello <i>Level</i>	Definizione <i>Definition</i>
f	Resistente agli olii. <i>Oil resistant.</i>
H	Apparecchiatura ad alta tensione. <i>High-voltage equipment.</i>
M	Provato contro gli effetti dannosi dovuti all'ingresso di acqua quando le sue parti sono in movimento. <i>Tested against the harmful effects due to the ingress of water when its movable parts are in motion.</i>
S	Provato contro gli effetti dannosi dovuti all'ingresso di acqua quando le sue parti non sono in movimento. <i>Tested against the harmful effects due to the ingress of water when its movable parts are not in motion.</i>
W	Adatto all'uso in condizioni atmosferiche specifiche e dotato di misure o procedimenti protettivi addizionali. <i>Suitable for use under specific atmospheric conditions and provided with additional protective measures or proceedings.</i>

K.2 Grado di protezione NEMA Degree of protection NEMA

Negli Stati Uniti d'America il grado di protezione degli involucri viene definito attraverso il "Type" (tipo di involucro) in accordo alla classificazione NEMA (National Electrical Manufacturers Association). Quest'ultima, a differenza delle prescrizioni delle norme europee, include condizioni specifiche quali la corrosione, la ruggine, il ghiaccio, gli olii e i fluidi refrigeranti; la classificazione NEMA prende inoltre in considerazione usi in ambienti interni, esterni e in zone a pericolo di esplosione. Nelle tabelle che seguono vengono indicati i tipi (Type) di involucri e le condizioni alle quali viene fornita protezione sia per ambienti pericolosi che per ambienti non pericolosi.

On the USA market the enclosures' degrees of protection is defined by the "Type" (type of enclosure) according to NEMA (National Electrical Manufacturers Association) classification. NEMA, unlike the European standards, includes specific conditions such as corrosion, rust, ice, oils and coolants; the NEMA classification takes also into consideration uses for indoor, outdoor and hazardous locations. In the following tables are indicated the Types of Enclosure and the conditions under which they provide protection in nonhazardous and hazardous locations.

Tabella K.5. Tipi (Type) di involucri per uso in ambienti non pericolosi

Table K.5. Type of enclosure for use in nonhazardous locations

Condizioni alle quali viene fornita protezione <i>Provides protection against the following conditions</i>	Tipo di involucro <i>Type of Enclosure</i>															
	1 ^(a)	2 ^(a)	3	3X	3R ^(a)	3RX ^(a)	3S	3SX	4	4X	5	6	6P	12	12K	13
Ambienti interni <i>Indoor</i>	•	•	•	•	•	•	•	•	•	•	•	•	•	•	•	•
Ambienti esterni <i>Outdoor</i>			•	•	•	•	•	•	•	•	•	•	•			
Accesso a parti pericolose <i>Access to hazardous parts</i>	•	•	•	•	•	•	•	•	•	•	•	•	•	•	•	•
Ingresso di corpi solidi estranei (sporcizia che cade) <i>Ingress of solid foreign objects (falling dirt)</i>	•	•							•	•	•	•	•	•	•	•
Ingresso di corpi solidi estranei (deposito di polveri in sospensione, filamenti, fibre e composti volatili ^(b)) <i>Ingress of solid foreign objects (settling airborne dust, lint, fibers, and flyings ^(b))</i>									•	•	•	•	•	•	•	•
Ingresso di corpi solidi estranei (polveri in circolazione, filamenti, fibre e composti volatili ^(b)) <i>Ingress of solid foreign objects (circulating dust, lint, fibers, and flyings ^(b))</i>									•	•	•	•	•	•	•	•
Ingresso di corpi solidi estranei (polveri soffiate dal vento, filamenti, fibre e composti volatili ^(b)) <i>Ingress of solid foreign objects (windblown dust, lint, fibers, and flyings ^(b))</i>			•	•			•	•	•	•		•	•			
Ingresso di acqua (gocce e spruzzi leggeri) <i>Ingress of water (dripping and light splashing)</i>		•							•	•	•	•	•	•	•	•
Ingresso di acqua (pioggia, neve, nevischio ^(c)) <i>Ingress of water (rain, snow, and sleet ^(c))</i>			•	•	•	•	•	•	•	•		•	•			
Ingresso di acqua (lavaggi e spruzzi) <i>Ingress of water (hosedown and splashing water)</i>									•	•		•	•			
Nevischio ^(d) <i>Sleet ^(d)</i>							•	•								
Ingresso d'acqua (immersione temporanea occasionale) <i>Ingress of water (occasional temporary submersion)</i>												•	•			
Ingresso d'acqua (immersione prolungata occasionale) <i>Ingress of water (occasional prolonged submersion)</i>													•			
Infiltrazioni di olii e refrigeranti <i>Oil and coolant seepage</i>														•	•	•
Spruzzi e schizzi di olii e refrigeranti <i>Oil or coolant spraying and splashing</i>																•
Agenti corrosivi <i>Corrosive agents</i>				•		•		•		•			•			

(a) Questi involucri possono essere ventilati.

(b) Queste fibre e composti volatili non sono intesi come materiali e non sono da considerare come fibre e composti volatili in Classe III. Per maggiori informazioni sulle fibre e i composti volatili infiammabili in Classe III fare riferimento all'Articolo 500 del National Electrical Code (NEC).

(c) Non è richiesto che i meccanismi operativi esterni siano funzionanti quando l'involucro è coperto di ghiaccio.

(d) È richiesto che i meccanismi operativi esterni siano funzionanti quando l'involucro è coperto di ghiaccio.

(a) These enclosures may be ventilated.

(b) These fibers and flyings are nonhazardous materials and are not considered Class III type ignitable fibers or combustible flyings. For Class III type ignitable fibers or combustible flyings see the National Electrical Code, Article 500.

(c) External operating mechanisms are not required to be operable when the enclosure is ice covered.

(d) External operating mechanisms are operable when the enclosure is ice covered.

Tabella K.6. Tipi (Type) di involucri per uso in zone pericolose

Table K6. Type of enclosure for use in hazardous locations

Tipo di ambiente e componenti presenti nell'ambiente al quale viene fornita protezione ^(a) <i>Provides protection against the following typical chemicals contained in atmosphere and for the specified ambient type ^(a)</i>	Zona pericolosa corrispondente <i>Related hazardous locations</i>	Tipo di involucro ^(b) <i>Type of Enclosure ^(b)</i>			
		7	8	9	10
Ambienti interni <i>Indoor</i>	-	•	•	•	cfr. ^(d)
Ambienti esterni <i>Outdoor</i>	-		•		cfr. ^(d)
Acetilene <i>Acetylene</i>	Class I Group A	•	•		
Idrogeno, gas manifatturato <i>Hydrogen, manufactured gas</i>	Class I Group B	•	•		
Etere etilico, etilene, ciclopropano <i>Diethyl ether, ethylene, cyclopropane</i>	Class I Group C	•	•		
Benzina, esano, butano, nafta, propano, acetone, toluene, isoprene <i>Gasoline, hexane, butane, naphtha, propane, acetone, toluene, isoprene</i>	Class I Group D	•	•		
Polvere metallica <i>Metal dust</i>	Class I Group E			•	
Nero di carbone, polvere di carbone, polvere di coke <i>Carbon black, coal dust, coke dust</i>	Class II Group F			•	
Farina, amido, polvere di grano <i>Flour, starch, grain dust</i>	Class II Group G			•	
Fibre, composti volatili ^(c) <i>Fibers, flyings ^(c)</i>	Class III Group G			•	
Metano con o senza polvere di carbone <i>Methane with or without coal dust</i>	MSHA ^(d)				•

(a) Se l'installazione dei Type 7, 8, 9 e 10 è all'esterno e/o è richiesta una protezione supplementare per le condizioni di Tabella K.5, è necessario un involucro di tipo combinato.

(b) A causa delle caratteristiche del gas, del vapore o della polvere, un prodotto adatto per una Classe o Gruppo può non essere adatto per un'altra Classe o Gruppo a meno che non sia marcato sul prodotto.

(c) Per le fibre ed i composti volatili infiammabili in Classe III fare riferimento all'Articolo 500 del National Electrical Code (NEC).

(d) Mine Safety and Health Administration, 30 CFR, Part 18.

(a) If the installation of Type 7, 8, 9 and 10 is outdoors and/or additional protection is required by Table K.5, a combination-type enclosure is required.

(b) Due to the characteristics of the gas, vapor, or dust, a product suitable for one Class or Group may not be suitable for another Class or Group unless marked on the product.

(c) For Class III type ignitable fibers or combustible flyings see the National Electrical Code, Article 500.

(d) Mine Safety and Health Administration, 30 CFR, Part 18.

K.3 Correlazione tra gradi di protezione Conversion between degrees of protection

Il documento NEMA n. 250 (appendice A) fornisce una correlazione tra i tipi di involucri riconosciuti ed i gradi di protezione degli involucri secondo la classificazione europea (grado IP). Poiché la norma europea non prevede specifici gradi di protezione contro il danno meccanico delle apparecchiature elettriche, i rischi di esplosione o condizioni particolari quali la condensa, vapori corrosivi, ecc. la correlazione con i gradi di protezione IP non è univoca e vincolante. I gradi di protezione definiti dalle norme IEC sono formati dalle lettere IP seguite da due parti numeriche. La prima parte caratteristica indica il grado di protezione fornito dall'involucro contro l'accesso a parti pericolose e la penetrazione di corpi solidi. La seconda parte caratteristica indica il grado di protezione fornito dall'involucro rispetto agli effetti dannosi prodotti dalla penetrazione di acqua. Le seguenti tabelle forniscono una correlazione degli involucri definiti da NEMA (Type) e la classificazione IEC (IP) e si basa sul concetto che i tipi di involucri NEMA soddisfano o superano i requisiti di prova delle relative classificazioni IEC associate, per questo motivo le tabelle non possono essere usate per operare una conversione da classificazione IEC (IP) al tipo (Type) di involucro NEMA.

The NEMA standard n.250 (Appendix A) gives a correlation among the recognized enclosures and the degrees of protection of the enclosures according to IP classification. As the European standard does not specify degrees of protection against the mechanical damage of equipment, risk of explosion or particular conditions such as moisture, corrosive vapors, etc., the correlation with the IP degrees of protection is not univocal and binding. The IEC designation consists of the letters IP followed by two numerals. The first characteristic numeral indicates the degree of protection provided by the enclosure with respect to persons and solid foreign objects entering the enclosure. The second characteristic numeral indicates the degree of protection provided by the enclosure with respect to the harmful ingress of water.

The following tables provide an equivalent conversion from the enclosure NEMA Type numbers to the IEC enclosure classification designations IP. The enclosure type numbers meet or exceed the test requirements for the associated IEC classification; for this reason the tables cannot be used to convert from IEC classifications to enclosure NEMA Type numbers.

Tabella K.7. Correlazione della classificazione NEMA con la prima parte del codice IP

Table K.7. Conversion of NEMA enclosures with the first part of the IP code.

Prima parte del codice IP First part of the IP code	Tipo (Type) di involucro NEMA NEMA Type of Enclosure															
	1	2	3	3X	3R	3RX	3S	3SX	4	4X	5	6	6P	12	12K	13
IP0_	•	•	•	•	•	•	•	•	•	•	•	•	•	•	•	•
IP1_	•	•	•	•	•	•	•	•	•	•	•	•	•	•	•	•
IP2_	•	•	•	•	•	•	•	•	•	•	•	•	•	•	•	•
IP3_			•	•			•	•	•	•	•	•	•	•	•	•
IP4_			•	•			•	•	•	•	•	•	•	•	•	•
IP5_			•	•			•	•	•	•	•	•	•	•	•	•
IP6_									•	•		•	•			

Tabella K.8. Correlazione della classificazione NEMA con la seconda parte del codice IP

Table K.8. Conversion of NEMA enclosures with the second part of the IP code.

Seconda parte del codice IP Second part of the IP code	Tipo di involucro NEMA NEMA Type of Enclosure															
	1	2	3	3X	3R	3RX	3S	3SX	4	4X	5	6	6P	12	12K	13
IP_0	•	•	•	•	•	•	•	•	•	•	•	•	•	•	•	•
IP_1		•	•	•	•	•	•	•	•	•	•	•	•	•	•	•
IP_2		•	•	•	•	•	•	•	•	•	•	•	•	•	•	•
IP_3			•	•	•	•	•	•	•	•	•	•	•	•	•	•
IP_4			•	•	•	•	•	•	•		•	•	•	•	•	•
IP_5			•	•			•	•	•	•		•	•			
IP_6									•	•		•	•			
IP_7												•	•			
IP_8												•	•			

Per comodità si riportano in tabella i tipi di involucri NEMA ed i relativi massimi gradi di protezione IP corrispondenti.

For convenience, the table below sets the NEMA Types of enclosures and the correspondent maximum degree of protection IP.

Tabella K.9. Correlazione della classificazione NEMA con il massimo grado di protezione IP corrispondente.

Table K.9. Conversion of NEMA enclosures with the correspondent maximum degree of protection IP.

Tipo di involucro NEMA NEMA Type of Enclosure	1	2	3	3X	3R	3RX	3S	3SX	4	4X	5	6	6P	12	12K	13
Grado di protezione IP IP Degree of protection	IP20	IP22	IP55	IP55	IP24	IP24	IP55	IP55	IP66	IP66	IP53	IP67	IP68	IP54	IP54	IP54

Esempio

È specificato il grado di protezione IP65 per un involucro, quali sono i tipi (Type) di involucri NEMA che soddisfano o superano i requisiti per questo grado di protezione?

Example

A IP65 degree of protection is defined, what are the types (Type) of NEMA enclosures that meet or exceed the requirements for this degree of protection?

Utilizzando la tabella K.7 si individuano i tipi di involucri NEMA che soddisfano la prima parte del codice IP mentre con la tabella K.8 quelli che soddisfano la seconda parte del codice IP.

Using table K.7 identifies the NEMA types of enclosures that satisfy the first part of the IP code, with table K.8 those which satisfy the second part of the IP code.

Correlazione Conversion	1	2	3	3X	3R	3RX	3S	3SX	4	4X	5	6	6P	12	12K	13
IP6_									•	•		•	•			
IP_5			•	•			•	•	•	•		•	•			
Nella riga sotto si indicano i tipi di involucri in comune. On the row below only the common type of enclosures are listed																
IP65									•	•		•	•			

Quindi i tipi (Type) 4, 4X, 6 e 6P soddisfano o superano i requisiti richiesti per il grado di protezione IP65.

Finally the NEMA types 4, 4X, 6 and 6P meet or exceed the requirements for the degree of protection IP65.

Appendice L. Hazardous locations

Appendix L. Hazardous locations

L'ANSI/NFPA 70 "National Electrical Code" (NEC) definisce le aree pericolose (hazardous locations) come quelle aree dove può sussistere il pericolo di incendio o di esplosione a causa di gas infiammabili, vapori infiammabili, liquidi infiammabili, polveri combustibili o fibre o volatili combustibili. Il NEC dedica molta attenzione alle hazardous locations perchè le apparecchiature elettriche possono diventare origine di incendi all'interno di queste aree. Gli articoli dal 500 al 504 e dal 510 al 517 forniscono una classificazione e le regole di installazione per l'uso di apparecchiature elettriche all'interno delle hazardous locations.

Il sistema di classificazione delle hazardous locations avviene su tre livelli: tipo di area, condizione del pericolo e natura del materiale presente nell'area.

I tipi di hazardous locations sono tre.

Il primo tipo di area, definita Class I, è quella in cui vi è la presenza di gas o vapori in atmosfera in quantità tali da far sussistere il rischio di esplosione che può essere innescata dalla presenza di apparecchiature elettriche o di altra natura.

Il secondo tipo di area, definita Class II, è quella in cui vi sono polveri combustibili, eventualmente anche in sospensione nell'aria, che possono causare un'esplosione.

Il terzo tipo di area, definita Class III, è quella in cui vi è la presenza di fibre o volatili facilmente combustibili generate in seguito al trattamento, immagazzinamento o la trasformazione di alcune tipologie di materiali. In questo caso le fibre o i volatili possono raccogliersi intorno al macchinario e, una volta riscaldate, possono incendiarsi a causa di una scintilla o di parti metalliche eccessivamente calde.

Oltre al tipo il NEC definisce le condizioni per cui sussiste il pericolo. I materiali presenti nell'area possono essere pericolosi sotto differenti condizioni, per semplicità il NEC suddivide queste condizioni in condizioni normali, definite Division 1, e condizioni anormali, definite Division 2. In condizioni normali il pericolo sussiste costantemente durante la produzione o durante frequenti attività di riparazione o di manutenzione. Quando invece il materiale pericoloso è confinato all'interno di sistemi chiusi (per esempio dei contenitori) ed è presente in atmosfera solo a causa di una rottura, una perdita o una operazione errata allora la condizione viene definita anormale.

Infine il NEC definisce la natura dei materiali pericolosi presenti nell'area raggruppandoli in funzione della temperatura di combustione, della pressione di esplosione o di altre caratteristiche di infiammabilità (Group A, B, C, D, E, F, G).

Immaginiamo di dover classificare un'area in cui viene immagazzinato del GPL in serbatoi chiusi. Il GPL è un gas e quindi la zona di immagazzinamento rientra nel tipo definito Class I; il gas può essere presente in atmosfera solo in seguito ad una perdita o ad una rottura accidentale di uno o più serbatoi e quindi si tratta di una condizione anormale definita Division 2. Infine il materiale, gas di petrolio liquefatto, rientra nel Group D come si può facilmente individuare dalla tabella che segue.

In Europa le aree pericolose vengono classificate dalla norma EN 60079-10 ed in Canada dal Canadian Electrical Code.

The ANSI/NFPA 70 "National Electrical Code" (NEC) defines the Hazardous Locations as locations where fire or explosion hazards may exist due to flammable gases or vapors, flammable liquids, combustible dust, or ignitable fibers or flyings. The NEC pays attention to the hazardous locations because the electrical equipment can become source of ignition in these volatile areas. Articles 500 through 504, and 510 through 517 provide classification and installation standards for the use of electrical equipment in these locations.

Hazardous locations are classified in three ways: location types, danger condition and nature of the material in the location.

There are three types of hazardous locations.

The first type of location, Class I, is an area where flammable gases or vapours in the air are present in concentrations suitable to produce, which could be ignited if an electrical or other source of ignition is present.

The second type of location, Class II, is the area made hazardous by the presence of combustible dust, suspended in the atmosphere, which can cause an explosion.

The third type of location, Class III, is the area where there are easily-ignitable fibers or flyings present, due to the types of materials being handled, stored or processed. In this case the fibers or the flyings can collect around machinery where heat, a spark or hot metals parts can ignite them.

In addition to the types of hazardous locations, the NEC concerns itself with the kind of conditions under which the hazard is present. The hazardous materials may exist in several different kinds of conditions which, for simplicity, the NEC describe as normal conditions, Division 1, and abnormal conditions, Division 2. In the normal condition, the hazard would be expected to be present in everyday production operations or during frequent repair and maintenance activity. While, when the hazardous material is expected to be confined within closed systems (e.g. containers) and is present in the atmosphere only through accidental rupture, breakage or unusual faulty operation, the situation could be called abnormal.

Finally, the NEC defines the nature of the hazardous materials which are present in the location, grouping them according to the ignition temperature, the explosion pressure and other flammable characteristics (Group A, B, C, D, E, F, G).

An example: how would we classify a storage area where LP gas is contained in closed containers? LP gas is a Class I substance; the gas would be present in the atmosphere only if a leakage or an accidental rupture of one or more containers occurred, so it is an abnormal condition, Division 2. Finally, the material, liquid petroleum gas, belongs to Group D material, as shown in the following table.

In Europe the hazardous locations are classified by EN 60079-10 standard, and in Canada by the Canadian Electrical Code.

Tabella L.1. Hazardous locations secondo l'Art. 500 del NFPA 70 (NEC) - Ed. 2008/2011

Table L.1. Hazardous locations according to Art. 500 of NFPA 70 (NEC) - Ed. 2008/2011

Tipo di area <i>Type of location</i>	Condizione del pericolo <i>Hazardous condition</i>	Natura del materiale <i>Nature of the material</i>	Esempi <i>Examples</i>
<p>Class I (Art. 501 del NEC) Sono aree in cui la presenza di gas o vapori infiammabili in aria è (o può essere) tale da produrre miscele esplosive o infiammabili.</p> <p>Class I (Art. 501 of NEC) <i>Locations in which flammable gases or vapors are or may be present in the air in quantities sufficient to produce explosive or ignitable mixtures.</i></p>	<p>Division 1 Sono aree in cui, in condizioni normali, la concentrazione pericolosa di gas o vapori infiammabili è presente in modo continuo, intermittente o periodico. Oppure sono aree in cui la concentrazione pericolosa di gas o vapori infiammabili può essere presente frequentemente a causa di operazioni di riparazione, manutenzione o a causa di una perdita. Oppure sono aree in cui un guasto o un difetto nell'operatività della macchina o del processo può rilasciare concentrazioni pericolose di gas o vapori infiammabili.</p> <p>Division 2 Sono aree in cui liquidi volatili infiammabili o gas infiammabili sono trattati, processati o usati ma sono normalmente tenuti in contenitori chiusi e possono fuoriuscire solo per una rottura accidentale. Oppure sono aree in cui la concentrazione pericolosa di gas o vapori sono normalmente soggetti a sistemi di ventilazione meccanica e possono diventare pericolosi in seguito al guasto del sistema di ventilazione. Oppure sono aree adiacenti alle aree Class I, Division 1.</p> <p>Division 1 <i>Locations in which ignitable concentrations of flammable gases or vapors can exist under normal operating conditions. Or in which ignitable concentrations of such gases or vapors may exist frequently because of repair or maintenance operations or because of leakage. Or in which breakdown or faulty operation of equipment or processes might release ignitable concentrations of flammable gases or vapors and might also cause simultaneous failure of electrical equipment in such a way as to directly cause the electrical equipment to become a source of ignition.</i></p> <p>Division 2 <i>Locations in which volatile flammable liquids or flammable gases are handled, processed, or used, but in which the liquids, vapors, or gases will normally be confined within closed containers or closed systems from which they can escape only in case of accidental rupture or breakdown of such containers or systems or in case of abnormal operation of equipment. Or in which ignitable concentrations of gases or vapors are normally prevented by positive mechanical ventilation and which might become hazardous through failure or abnormal operation of the ventilating equipment. Or that is adjacent to a Class I, Division 1 location, and to which ignitable concentrations of gases or vapors might occasionally be communicated unless such communication is prevented by adequate positive-pressure ventilation from a source of clean air and effective safeguards against ventilation failure are provided.</i></p>	<p>Group A Atmosfere contenenti acetilene.</p> <p>Group B Atmosfere contenenti idrogeno o materiali dalle caratteristiche simili.</p> <p>Group C Atmosfere contenenti etilene o materiali dalle caratteristiche simili.</p> <p>Group D Atmosfere contenenti butano, benzina, gas naturale, propano.</p> <p>Group A <i>Atmospheres containing acetylene.</i></p> <p>Group B <i>Atmospheres containing hydrogen or other materials with similar characteristics.</i></p> <p>Group C <i>Atmospheres containing ethylene or other materials with similar characteristics.</i></p> <p>Group D <i>Atmospheres containing butane, gasoline, natural gas and propane.</i></p>	<p>All'interno di questa classificazione vi sono le raffinerie di petrolio, i depositi e i distributori di benzina; gli stabilimenti per la pulizia a secco dove possono essere presenti vapori provenienti dai fluidi di pulizia; gli hangar per aerei e le aree per i rifornimenti; le aree per il deposito e la distribuzione di GPL o gas naturale.</p> <p>Tutte queste aree richiedono attrezzature e componenti speciali omologati in Class I.</p> <p><i>Within this classifications there are the petroleum refineries, petrol pumps and storages; plants for dry cleaning where could be present vapours coming out from the cleaning fluids; hangars for airplanes and petrol stations; areas for the stowage and distribution of LP gas or natural gas.</i></p> <p><i>All these areas require special equipments and components homologated in Class I.</i></p>

Tipo di area <i>Type of location</i>	Condizione del pericolo <i>Hazardous condition</i>	Natura del materiale <i>Nature of the material</i>	Esempi <i>Examples</i>
<p>Class II (Art. 502 del NEC) Sono aree in cui sono presenti miscele esplosive di aria e polveri combustibili.</p> <p>Class II (Art. 502 of NEC) <i>Locations hazardous because of the presence of combustible dust.</i></p>	<p>Division 1 Sono aree in cui, in condizioni normali, le polveri combustibili in quantità esplosive o infiammabili sono o possono essere in sospensione in modo continuo, intermittente o periodico. Oppure sono aree dove guasti meccanici o operazioni errate di macchine o attrezzature possono generare miscele esplosive o infiammabili. Oppure sono aree in cui sono presenti polveri combustibili elettricamente conduttive.</p> <p>Division 2 Sono aree dove esistono depositi di polveri combustibili che non sono in sospensione nell'aria ma sono sufficientemente pesanti da interferire con i sistemi di dissipazione del calore delle attrezzature elettriche. Oppure sono aree dove esistono depositi di polveri combustibili che possono prendere fuoco a causa di scariche elettriche, scintille o materiali che bruciano dovuti alle apparecchiature elettriche.</p> <p>Division 1 <i>Locations in which combustible dust is in the air under normal operating conditions in quantities sufficient to produce explosive or ignitable mixtures.</i> <i>Or where mechanical failure or abnormal operation of machinery or equipment might cause such explosive or ignitable mixtures to be produced, and might also provide a source of ignition through simultaneous failure of electric equipment, through operation of protection devices, or from other causes.</i> <i>Or in which Group E combustible dusts may be present in quantities sufficient to be hazardous.</i></p> <p>Division 2 <i>Locations in which combustible dust due to abnormal operations may be present in the air in quantities sufficient to produce explosive or ignitable mixtures.</i> <i>Or where combustible dust accumulations are present but are normally insufficient to interfere with the normal operation of electrical equipment or other apparatus, but could as a result of infrequent malfunctioning of handling or processing equipment become suspended in the air.</i> <i>Or in which combustible dust accumulations on, in, or in the vicinity of the electrical equipment could be sufficient to interfere with the safe dissipation of heat from electrical equipment, or could be ignitable by abnormal operation or failure of electrical equipment.</i></p>	<p>Group E Atmosfere contenenti polveri metalliche quali quelle di alluminio o magnasio.</p> <p>Group F Atmosfere contenenti combustibili quali il carbone.</p> <p>Group G Atmosfere contenenti polveri di cereali, farina, amido e materiali simili. Nessun raggruppamento.</p> <p>Group E <i>Atmospheres containing metal dusts such as aluminium or magnesium dust.</i></p> <p>Group F <i>Atmospheres containing explosive dusts such as carbon dust.</i></p> <p>Group G <i>Atmospheres containing flour, starch, grain and similar materials.</i></p>	<p>All'interno di questa classificazione vi sono impianti di trasporto di cereali, mulini, impianti per la produzione di farina; impianti per la produzione, l'impiego o l'immagazzinamento di polveri di alluminio o magnesio; macchine per la produzione di plastiche, medicinali e fuochi di artificio; impianti per la produzione di caramelle e la lavorazione dello zucchero; stabilimenti per il trattamento o la trasformazione del carbone. All'interno di questa classificazione rientrano gli impianti per la produzione di tessuti o la lavorazione del cotone; macchine per la lavorazione o il taglio del legno e la produzione di segatura o fibra di vetro.</p> <p><i>Within this classification are transport systems for grain, mills, system for flour production; systems for the production, the use of the storage of aluminium or magnesium dusts; machinery for the manufacturing of plastics, medicinal, fireworks; systems for sweets production and sugar processing; plants for carbon treatment and transformation.</i></p>

Tipo di area <i>Type of location</i>	Condizione del pericolo <i>Hazardous condition</i>	Natura del materiale <i>Nature of the material</i>	Esempi <i>Examples</i>
<p>Class III (Art. 503 del NEC) Sono aree in cui c'è la presenza di fibre o volatili facilmente infiammabili ma che non sono in sospensione nell'aria in quantità tali da produrre miscele infiammabili.</p> <p>Class III (Art. 503 of NEC) <i>Locations hazardous because of the presence of easily ignitable fibers or flyings, but in which such fibers or flyings are not likely to be in suspension in the air in quantities sufficient to produce ignitable mixtures.</i></p>	<p>Division 1 Sono aree nelle quali fibre facilmente infiammabili o materiali che generano volatili sono trattati, prodotti o usati.</p> <p>Division 2 Sono aree nelle quali fibre facilmente infiammabili sono immagazzinate o trattate (eccetto che nel processo di produzione).</p> <p>Division 1 <i>Locations in which easily ignitable fibers or materials producing combustible flyings are handled, manufactured, or used.</i></p> <p>Division 2 <i>Locations in which easily ignitable fibers are stored or handled other than in the process of manufacture.</i></p>	<p>Nessun raggruppamento.</p> <p><i>No group.</i></p>	<p>All'interno di questa classificazione rientrano gli impianti per la produzione di tessuti o la lavorazione del cotone; macchine per la lavorazione o il taglio del legno e la produzione di segatura o fibra di vetro.</p> <p><i>Within this classification are included the systems for the production of fabrics or for cotton processing; machinery for wood processing or cutting and for the production of sawdust or fiber glass.</i></p>

Con esplicito riferimento a quanto esposto nel capitolo relativo ai gradi di protezione degli involucri, gli standard relativi alle hazardous locations definiscono i TYPE degli involucri che possono essere utilizzati per dette aree.

With explicit reference to the chapter concerning the degrees of protection of the enclosures, the standards concerning the hazardous locations define the TYPE of enclosures which can be used for such locations.

Tabella L.2. Classificazione NEMA degli involucri da impiegare nelle hazardous locations

Table L.2. NEMA classification of enclosures to be used in the hazardous locations

Type	Tipo di involucri per indoor use in hazardous locations <i>Type of enclosures for indoor use in hazardous locations</i>
NEMA 7	Involucri costruiti per uso interno in zone classificate come Class I, Division 1, Group A, B, C o D. Sono involucri costruiti per contenere esplosioni interne senza causare danni esterni. <i>Enclosures for indoor use in locations classified as Class I, Division 1, Group A, B, C or D. Enclosures constructed to contain internal explosions without causing external damages.</i>
NEMA 8	Involucri costruiti per uso interno o esterno in zone classificate come Class I, Division 1, Group A, B, C o D. Sono involucri costruiti per prevenire la combustione attraverso l'uso di apparecchiature immerse in olio. <i>Enclosures for indoor or outdoor use in locations classified as Class I, Division 1, Group A, B, C or D. Enclosures constructed to prevent the combustion through the use of oil-immersed equipment.</i>
NEMA 9	Involucri costruiti per uso interno in zone classificate come Class II, Division 1, Group E, F o G. Sono involucri costruiti per prevenire l'innesco di polveri combustibili. <i>Enclosures for indoor or outdoor use in locations classified as Class I, Division 1, Group A, B, C or D. Enclosures constructed to prevent the combustion through the use of oil-immersed equipment.</i>
NEMA 10	Involucri costruiti per rispondere ai requisiti delle Mine Safety and Health Administration, 30 CFR, Part. 18. Sono involucri costruiti per contenere esplosioni interne senza causare danni esterni. <i>Enclosures meeting the requirements of the Mine Safety and Health Administration, 30 CFR, Part. 18. Enclosures constructed to contain internal explosions without causing external damages.</i>

Appendice M. Test di resistenza al fuoco per cavi e conduttori

Appendix M. Cables and wires' flame resistance tests

I test di infiammabilità e la determinazione dei prodotti della combustione sono fondamentali per la tecnologia dei cavi; essi forniscono informazioni su come il fuoco si propaga lungo il cavo, nonché sulle potenziali minacce a persone e materiali in caso di incendio del cavo.

Al fine di assicurarsi che un determinato cavo soddisfi i necessari requisiti di resistenza alla fiamma, si possono usare una vasta gamma di test di resistenza. Questi test vengono in genere eseguiti con orientamento verticale o orizzontale su cavi singoli o su gruppi di cavi.

Flammability tests and determination of combustion products are vital to cable technology. They provide information on how fire spreads along the cable as well as on the potential threats to people and materials in the event of a cable fire.

In order to make sure that a particular cable meets the necessary flammability requirements, a wide range of different testing procedures are often used. These procedures are typically performed in either the vertical or horizontal orientation, on single cables or on group cables.

Metodo di test <i>Test method</i>	UL 1581 – Par. 1080 – VW-1 (Vertical Specimen) Flame test UL 2556 – Par. 9.4 – FV-2/VW-1
Descrizione <i>Description</i>	Cavo posizionato verticalmente. Un bruciatore è usato per applicare la fiamma ed è posizionato con un angolo di 20° rispetto alla verticale. <i>The cable is secured vertically. A burner is used to apply the flame and it is secured at an angle of 20° in respect to the vertical.</i>
Durata <i>Duration</i>	15 s di applicazione della fiamma e 15 s di pausa per 5 cicli. Quando la fiamma del campione persiste per più di 15 s dopo la rimozione del bruciatore, il bruciatore non deve essere riapplicato fino a quando la fiamma del campione non cessa. <i>15 s of flame application and 15 s of pause for 5 cycles. When flaming of the specimen persists longer than 15 s after removal of the burner flame, the burner flame shall not be re-applied until immediately after the flaming ceases.</i>
Conformità <i>Compliance</i>	L'indicatore di carta (P) non deve bruciare più del 25% e il campione non deve continuare a bruciare per più di 60 s. Il materiale che gocciola non deve incendiare l'ovatta di cotone (B) sottostante. <i>The paper indicator flag (P) shall not be burned more than 25% and the specimen shall not continue to burn for more than 60 s. Dripping material shall not ignite the cotton wool underneath (B).</i>

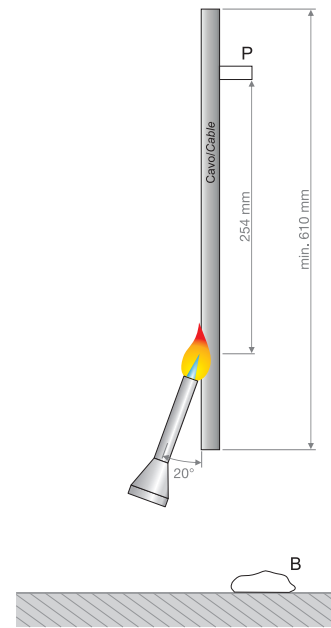

Metodo di test <i>Test method</i>	UL 1581 – Par. 1060 – Vertical Flame UL 2556 – Par. 9.5 – FV-1/Vertical flame
Descrizione <i>Description</i>	Cavo posizionato verticalmente. Un bruciatore è usato per applicare la fiamma ed è posizionato con un angolo di 20° rispetto alla verticale. <i>The cable is secured vertically. A burner is used to apply the flame and it is secured at an angle of 20° in respect to the vertical.</i>
Durata <i>Duration</i>	15 s di applicazione della fiamma e 15 s di pausa per 5 cicli. Il bruciatore deve essere riapplicato dopo 15 s, indipendentemente dal fatto che la fiamma del campione persista per più di 15 s. <i>15 s of flame application and 15 s of pause for 5 cycles. The burner flame shall be reapplied after 15 s, regardless of whether flaming of the specimen persists longer than 15 s.</i>
Conformità <i>Compliance</i>	L'indicatore di carta (P) non deve bruciare più del 25% e il campione non deve continuare a bruciare per più di 60 s. Il materiale che gocciola non deve incendiare l'ovatta di cotone (B) sottostante. <i>The paper indicator flag (P) shall not be burned more than 25% and the specimen shall not continue to burn for more than 60 s. Dripping material shall not ignite the cotton wool underneath (B).</i>

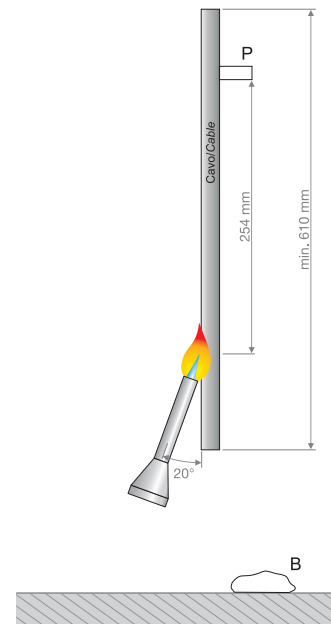

Metodo di test <i>Test method</i>	UL 1581 – Par. 1060 – FT1 UL 2556 – Par. 9.3 – FT1
Descrizione <i>Description</i>	Cavo posizionato verticalmente. Un bruciatore è usato per applicare la fiamma ed è posizionato con un angolo di 20° rispetto alla verticale. <i>The cable is secured vertically. A burner is used to apply the flame and it is secured at an angle of 20° in respect to the vertical.</i>
Durata <i>Duration</i>	15 s di applicazione della fiamma e 15 s di pausa per 5 cicli. Il bruciatore deve essere riapplicato dopo 15 s, indipendentemente dal fatto che la fiamma del campione persista per più di 15 s. <i>15 s of flame application and 15 s of pause for 5 cycles. The burner flame shall be reapplied after 15 s, regardless of whether flaming of the specimen persists longer than 15 s.</i>
Conformità <i>Compliance</i>	L'indicatore di carta (P) non deve bruciare più del 25% e il campione non deve continuare a bruciare per più di 60 s. Il materiale che gocciola o l'accensione dell'ovatta di cotone sottostante non vengono considerate per la conformità del test. <i>The paper indicator flag (P) shall not be burned more than 25% and the specimen shall not continue to burn for more than 60 s. Dripping material or the ignition of the cotton wool underneath (B) are ignored for the compliance of this test.</i>

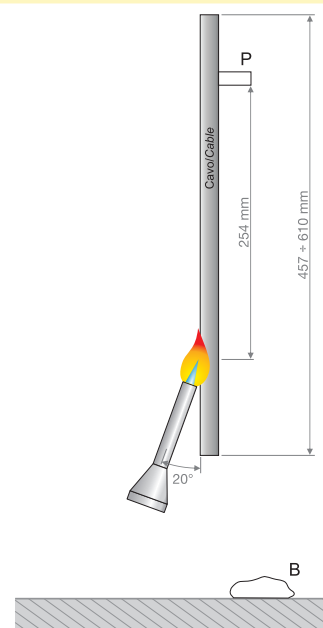

Metodo di test <i>Test method</i>	UL 1581 – Par. 1061 – Cable Flame test
Descrizione <i>Description</i>	Cavo posizionato verticalmente. Un bruciatore è usato per applicare la fiamma ed è posizionato con un angolo di 20° rispetto alla verticale. <i>The cable is secured vertically. A burner is used to apply the flame and it is secured at an angle of 20° in respect to the vertical.</i>
Durata <i>Duration</i>	60 s di applicazione della fiamma e 30 s di pausa per 3 cicli. Il bruciatore deve essere riapplicato dopo 30 s, indipendentemente dal fatto che la fiamma del campione persista per più di 30 s. <i>60 s of flame application and 30 s of pause for 3 cycles. The burner flame shall be reapplied after 30 s, regardless of whether flaming of the specimen persists longer than 30 s.</i>
Conformità <i>Compliance</i>	L'indicatore di carta (P) non deve bruciare più del 25% e il campione non deve continuare a bruciare per più di 60 s. Il materiale che gocciola non deve incendiare l'ovatta di cotone underneath (B) sottostante. <i>The paper indicator flag (P) shall not be burned more than 25% and the specimen shall not continue to burn for more than 60 s. Dripping material shall not ignite the cotton wool underneath (B).</i>

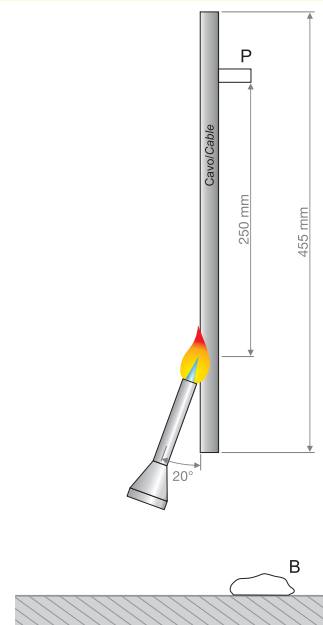

Metodo di test <i>Test method</i>	UL 1581 – Par. 1090 – Horizontal-Specimen Appliance-Wire Flame Test
Descrizione <i>Description</i>	Cavo posizionato orizzontalmente. Un bruciatore è usato per applicare la fiamma ed è posizionato verticalmente. <i>The cable is secured horizontally. A burner is used to apply the flame and it is secured vertically.</i>
Durata <i>Duration</i>	30 s di applicazione della fiamma. <i>30 s of flame application.</i>
Conformità <i>Compliance</i>	La velocità di propagazione della fiamma non deve eccedere 25 mm/min. Il materiale che gocciola non deve incendiare l'ovatta di cotone (B) posta nelle vicinanze del bruciatore. <i>The flame propagation speed must not exceed 25 mm/min. Dripping material shall not ignite the cotton wool (B) placed next to the burner.</i>

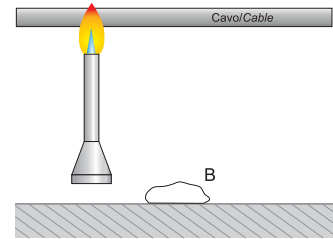

Metodo di test <i>Test method</i>	UL 1581 – Par. 1100 – Horizontal-Specimen / FT2 Flame Test UL 2556 – Par. 9.1 – FT2/FH/Horizontal flame
Descrizione <i>Description</i>	Cavo posizionato orizzontalmente. Un bruciatore è usato per applicare la fiamma ed è posizionato con un angolo di 20° rispetto alla verticale. <i>The cable is secured horizontally. A burner is used to apply the flame and it is secured at an angle of 20° in respect to the vertical.</i>
Durata <i>Duration</i>	30 s di applicazione della fiamma. <i>30 s of flame application.</i>
Conformità <i>Compliance</i>	La lunghezza del campione carbonizzato non deve essere superiore a 100 mm. Il materiale che gocciola non deve incendiare l'ovatta di cotone (B) posta nelle vicinanze del bruciatore. <i>The length of the carbonized specimen has to be no greater than 100 mm. Dripping material shall not ignite the cotton wool (B) placed next to the burner.</i>

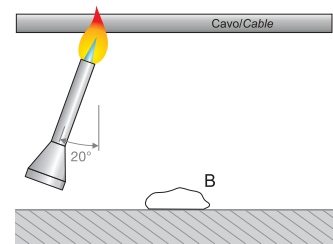

Metodo di test <i>Test method</i>	IEC 60332-1-2 / EN 60332-1-2
Descrizione <i>Description</i>	Cavo posizionato verticalmente. Un bruciatore è usato per applicare la fiamma ed è posizionato con un angolo di 45° rispetto alla verticale. <i>The cable is secured vertically. A burner is used to apply the flame and it is secured at an angle of 45° in respect to the vertical.</i>
Durata <i>Duration</i>	In relazione al diametro del cavo: 60 s ($D \leq 25$ mm), 120 s ($25 < D \leq 50$ mm), 240 s ($50 < D \leq 75$ mm), 480 s ($D > 75$ mm) <i>Based on the cable diameter: 60 s ($D \leq 25$ mm), 120 s ($25 < D \leq 50$ mm), 240 s ($50 < D \leq 75$ mm), 480 s ($D > 75$ mm)</i>
Conformità <i>Compliance</i>	Il danno da incendio deve terminare almeno 50 mm sotto il morsetto di fissaggio superiore. Il cavo deve essere autoestinguente. <i>The fire damage must end at least 50 mm below the upper fixing clamp. The cable must be self-extinguishing.</i>

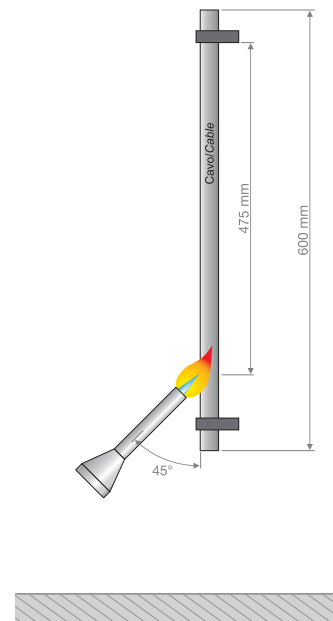

Metodo di test <i>Test method</i>	IEC 60332-2-2 / EN 60332-2-2
Descrizione <i>Description</i>	Cavo posizionato verticalmente. Un bruciatore è usato per applicare la fiamma ed è posizionato con un angolo di 45° rispetto alla verticale. <i>The cable is secured vertically. A burner is used to apply the flame and it is secured at an angle of 45° in respect to the vertical.</i>
Durata <i>Duration</i>	20 s
Conformità <i>Compliance</i>	Il danno da incendio deve terminare almeno 50 mm sotto il morsetto di fissaggio superiore. Il cavo deve essere autoestinguente. <i>The fire damage must end at least 50 mm below the upper fixing clamp. The cable must be self-extinguishing</i>

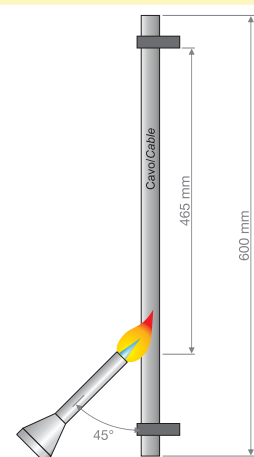

Metodo di test <i>Test method</i>	UL 2556 – Par. 9.6 – Vertical tray (Method 1) UL 1581 – Par. 1160 – Vertical Tray Flame Test UL 1685
Descrizione <i>Description</i>	Cavi posizionati verticalmente su singolo strato in una canalina a scaletta. Un bruciatore è usato per applicare la fiamma ed è posizionato orizzontalmente. <i>The cables are secured vertically to a ladder in a single layer. A burner is used to apply the flame and it is secured horizontally.</i>
Durata <i>Duration</i>	20 min di applicazione della fiamma per 2 test. <i>20 min of flame application for 2 tests.</i>
Conformità <i>Compliance</i>	L'area danneggiata dalla fiamma non deve estendersi oltre i 2440 mm misurati dalla base della canalina. <i>The damage height of all specimens shall be less than 2440 mm when measured from the bottom of the tray.</i>

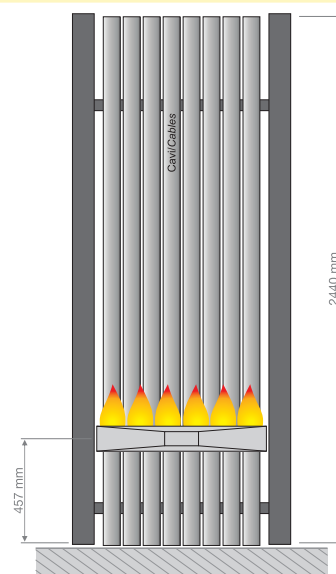

Metodo di test <i>Test method</i>	UL 2556 – Par. 9.6 – FT4 (Method 2)	
Descrizione <i>Description</i>	Cavi posizionati verticalmente su singolo strato in una canalina a scaletta. Un bruciatore è usato per applicare la fiamma ed è posizionato con un angolo di 20° rispetto alla verticale. <i>The cables are secured vertically to a ladder in a single layer. A burner is used to apply the flame and it is secured at an angle of 20° in respect to the vertical.</i>	
Durata <i>Duration</i>	20 min di applicazione della fiamma per 2 test. <i>20 min of flame application for 2 tests.</i>	
Conformità <i>Compliance</i>	L'area danneggiata dalla fiamma non deve estendersi oltre i 1500 mm misurati dalla base del bruciatore. <i>The damage height of all specimens shall be less than 1500 mm when measured from the bottom edge of the burner.</i>	

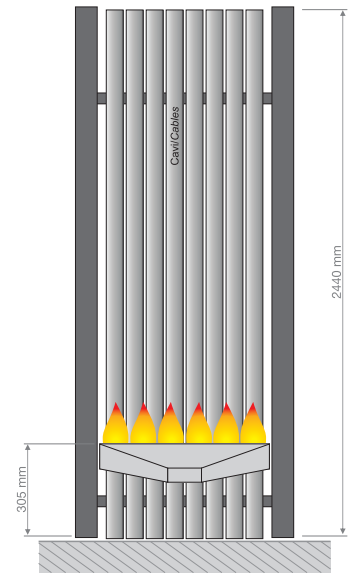

Metodo di test <i>Test method</i>	IEC 60332-3-24 / EN 60332-3-24	
Descrizione <i>Description</i>	Cavi posizionati verticalmente anche su più strati in una canalina a scaletta. Un bruciatore è usato per applicare la fiamma ed è posizionato orizzontalmente. <i>The cables are secured vertically to a ladder also in several layers. A burner is used to apply the flame and it is secured horizontally.</i>	
Durata <i>Duration</i>	20 min	
Conformità <i>Compliance</i>	L'area danneggiata dalla fiamma non deve estendersi oltre i 2500 mm misurati dalla base della canalina. <i>The damage height of all specimens shall be less than 2500 mm when measured from the bottom of the tray.</i>	

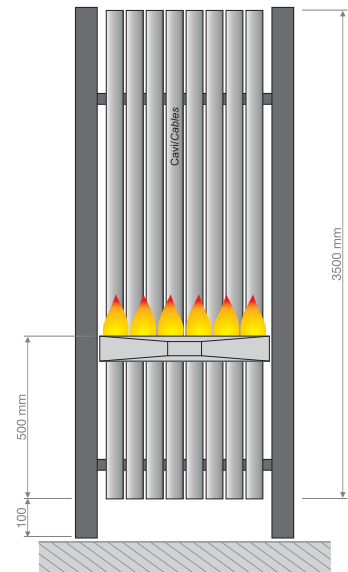

Appendice N. Classi di infiammabilità per materie plastiche

Appendix N. Flammability rating for plastic materials

UL 94 è la norma che definisce i test e le classi di infiammabilità per le materie plastiche usate nei componenti di dispositivi e elettrodomestici.

La norma classifica le materie plastiche in funzione del loro comportamento al fuoco, dalla meno resistente alla più resistente alla fiamma.

UL 94 is the Standard which defines the tests for flammability of plastic materials for parts in devices and appliances.

The standard classifies plastics according to how they burn in various orientations and thicknesses, from the least flame-retardant to most flame-retardant.

Classe HB – Combustione su provino orizzontale

Class HB – Horizontal burning test

Il provino è posizionato orizzontalmente ed esposto alla fiamma di un Bunsen ($h = 20$ mm) per 30 secondi. Viene registrata l'ignizione e la combustione.

La classificazione HB è definita sulla base della velocità di combustione dei provini di spessore fino a 13 mm (6 provini di 125 mm x 13 mm di dimensione).

I criteri di attribuzione della classe UL 94 HB:

- la velocità di combustione dei provini di spessore tra 3 e 13 mm su una distanza di 75 mm è ≤ 40 mm/min oppure
- la velocità di combustione dei provini di spessore fino a 3 mm su una distanza di 75 mm è ≤ 75 mm/min oppure
- la combustione si deve arrestare prima della marcatura dei 100 mm.

The specimen is placed horizontally and exposed to a Bunsen burner flame ($h = 20$ mm) for 30 seconds.

Any ignition or burning is noted. A HB classification is awarded on the basis of the burning rate of specimens (6 test specimens 125 mm x 13 mm) up to 13 mm thick.

Assessment criteria for UL 94 HB are:

- *burning rate of specimens between 3 and 13 mm thick over a distance of 75 mm is ≤ 40 mm/min or*
- *burning rate of specimens up to 3 mm thick over a distance of 75 mm is ≤ 75 mm/min or*
- *burning must cease before the 100 mm mark.*

Figura N.1. Combustione su provino orizzontale

Figure N.1. Horizontal burning test

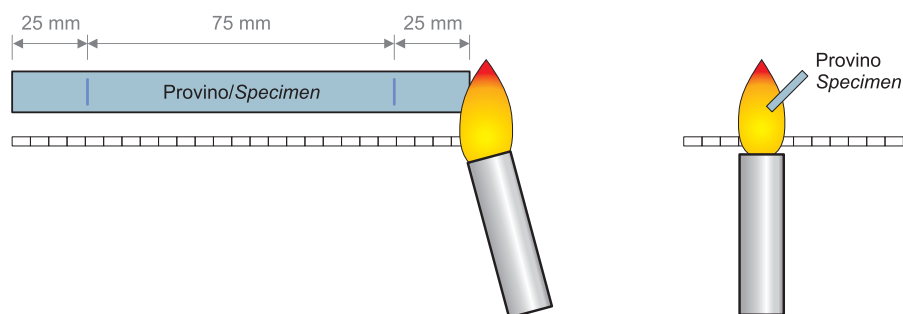

Classi V0, V1 e V2 – Combustione su provino verticale

Class V0, V1 e V2 – Vertical burning test

In questo test il provino è posizionato verticalmente ed esposto alla fiamma di un Bunsen ($h = 20$ mm) per due periodi di 10 secondi (il secondo periodo è applicato dopo estinzione della fiamma). I criteri di attribuzione della classe sono il tempo di combustione, il tempo totale di combustione e il gocciolamento di particelle combuste di provini di spessore fino a 13 mm (10 provini di 125 mm x 13 mm di dimensione).

In this test the specimen is placed vertically and exposed to a Bunsen burner flame ($h = 20$) for two periods of 10 seconds (the second period is applied after extinction).

The assessment criteria are burning time, total burning time and the dropping of burning particles of specimens (10 test specimens 125 mm x 13 mm) up to 13 mm thick as follows.

Classe <i>Classification</i>	V0	V1	V2
Tempo di combustione dopo ogni applicazione della fiamma <i>Burning time after each flame application</i>	≤ 10 sec	≤ 30 sec	≤ 30 sec
Tempo totale di combustione del lotto di provini <i>Total burning time per batch</i>	≤ 50 sec	≤ 250 sec	≤ 250 sec
Combustione per tutta l'altezza del provino <i>Burning up to the clamp</i>	No	No	No
Combustione ed incandescenza dopo seconda applicazione della fiamma <i>Burning and glowing time after second flame application</i>	≤ 30 sec	≤ 60 sec	≤ 60 sec
Ignizione del panno di cotone <i>Ignition of cotton wadding</i>	No	No	Si Yes

Figura N.2. Combustione su provino verticale

Figure N.2. Vertical burning test

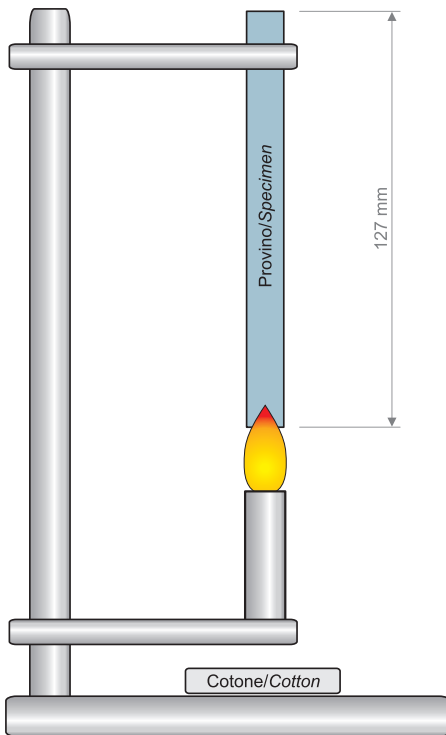

Appendice O. Trasporto, immagazzinamento e impiego dei cavi

Appendix O. Cables' transportation, storage and handling

0.1 Trasporto e immagazzinamento Transportation and storage

Le operazioni di sollevamento e spostamento devono essere eseguite in conformità con le normative e i requisiti legislativi e normativi locali. Prestare sempre attenzione al peso della bobina, al metodo e alla direzione di rotolamento e al metodo di movimentazione e sollevamento. Tutte le bobine devono essere trasportate utilizzando i bordi delle flange e non la superficie laterale.
Reasonable precautions must be taken in consideration to avoid damage to the cable and injury to people. Lifting and moving operations must be carried out in accordance with the relevant local regulations or codes of practice. Always pay attention to the weight of the drum, the method and direction of rolling and the method of handling and lifting. All reels or drums must be transported on their sides and are not allowed to lie on the flange.

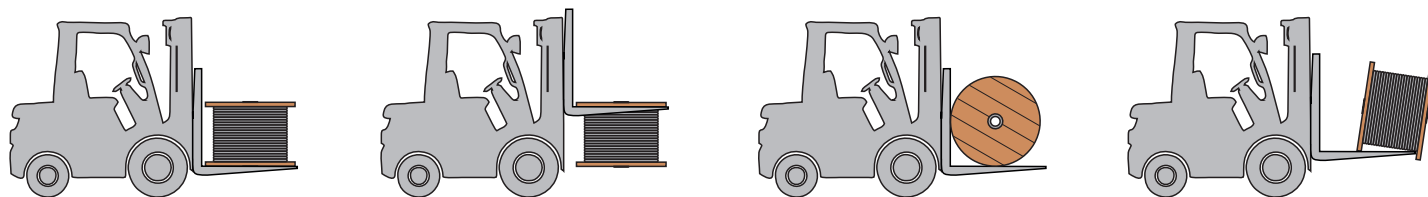

Non corretto / Wrong

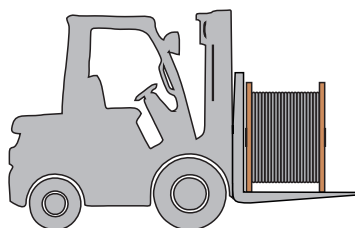

Corretto / Correct

Le bobine devono essere conservate in modo tale che le flange non entrino in contatto con il cavo di un'altra bobina. Le bobine devono essere conservate su una superficie piana, appoggiate sui bordi della flangia (non con la flangia piatta sul terreno) e deve essere evitato il rischio di rotolamento accidentale.

Cable drums should be stored so that the drum flanges do not contact cable on another drum. Drums should be stored on a level surface, on the flange edges (not with the flange flat on the ground) and restricted from rolling.

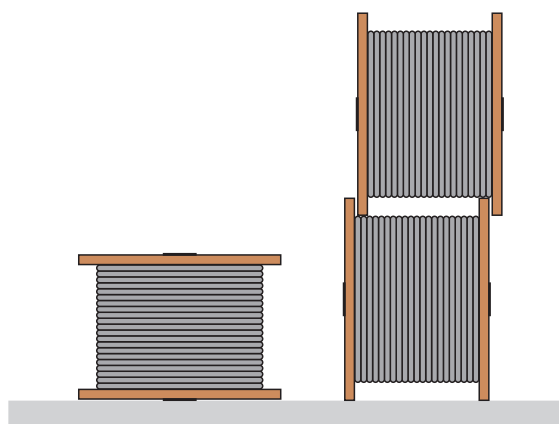

Non corretto / Wrong

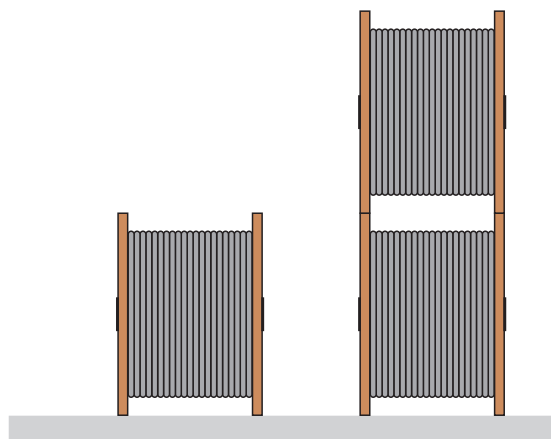

Corretto / Correct

I cavi non devono essere esposti a forti sbalzi di temperatura e, ove possibile, devono essere conservati all'interno. I cavi conservati in un luogo umido devono essere protetti sigillando l'estremità esposta dei cavi con tappi termorestringenti di protezione. I cavi conservati a temperature inferiori a quelle consigliate per l'installazione, non devono essere soggetti a sollecitazioni meccaniche, impatti, flessione o torsione. I cavi devono essere conservati in luoghi asciutti e privi di rischio di congelamento. I cavi con rivestimento esterno colorato non devono essere conservati alla luce diretta del sole per evitare danni e scolorimento. I cavi devono essere protetti dalla luce solare diretta con sistemi adeguati quali rivestimenti in plastica nera. I cavi non devono essere posti a contatto con sostanze chimiche e sostanze corrosive.

Cables should not be exposed to large temperature fluctuations and wherever possible must be stored indoor. Cables stored in wet location must be protected by sealing the exposed end with heat shrinkable end caps. Cables stored at temperatures below the ones recommended for installation, should not be subject to any mechanical stress, impacts, bending or torsions. Cables should be stored in a dry and frost-free locations. Cables with colored outer jacket should not be stored in direct sunlight to prevent damages and fading of the color. Cables should be protected against direct sun light with suitable protection package such as black plastic lagging. The cables must not be placed in contact with chemicals and corrosive media.

0.2 Impiego Handling

Prima dell'installazione, i cavi devono essere conservati per almeno 24 ore alla temperatura consigliata per l'installazione. I cavi devono essere utilizzati su un pavimento pulito senza parti in metallo o legno, chiodi, ecc. per evitare danni.

A temperature molto basse il materiale diventa rigido e possono verificarsi danni irreparabili. Poiché la sollecitazione meccanica sul cavo posato è significativamente inferiore a quella durante le operazioni di posa, la temperatura minima consentita per la posa è superiore alla temperatura minima consentita del cavo una volta posato. Se non diversamente specificato, la temperatura minima di posa è di -5°C per cavi con guaina in PVC, -20°C per cavi con guaina in PE e di $+5^{\circ}\text{C}$ per le fasi di avvolgimento e svolgimento da bobina. L'avvolgimento dalla parte superiore di una bobina alla parte inferiore dell'altra indurrà una torsione del cavo. Mantenere sempre la stessa direzione di avvolgimento dei cavi. Se non diversamente specificato, la massima sollecitazione di trazione dei conduttori in rame durante l'installazione deve essere di 50 N/mm^2 considerata come la somma della sollecitazione statica e dinamica; la sollecitazione residua massima dopo l'installazione e per applicazione fissa deve essere di 10 N/mm^2 . I cavi non devono mai essere piegati a un raggio di curvatura più stretto del raggio di curvatura minimo specificato nelle schede tecniche.

Prior to installation, the cables must be kept in-house storage for at least 24 hours to reach the temperature recommended for installation. Cables should be operated on clean floor without metal or wooden parts, nails, etc. to avoid any damage.

At very cold temperatures the material stiffens and becomes inflexible and irreparable damage can occur. Since the mechanical strain on the cable in its laid form is significantly less than the one during laying and use, the permissible minimum temperature is lower than the temperature valid for the installation period. Unless otherwise specified, minimum laying temperature is -5°C for PVC jacketed cables, -20°C for PE jacketed cables and it is $+5^{\circ}\text{C}$ for winding/unwinding process.

Spooling from the top of one reel to the bottom of the other will induce a twist in the cable. Always maintain direction of cable wraps throughout spooling system. Unless otherwise specified, the maximum tensile stress of the copper conductors during installation should be 50 N/mm^2 which as to be considered as the sum of the static and dynamic stress; residual stress after installation for fixed application should be 10 N/mm^2 . Cables must never be bend to a radius tighter than the minimum bending radius specified in the technical datasheets.

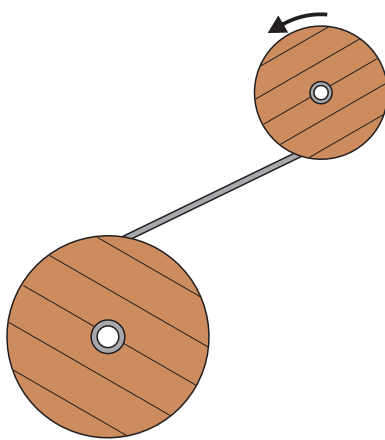

Non corretto / Wrong

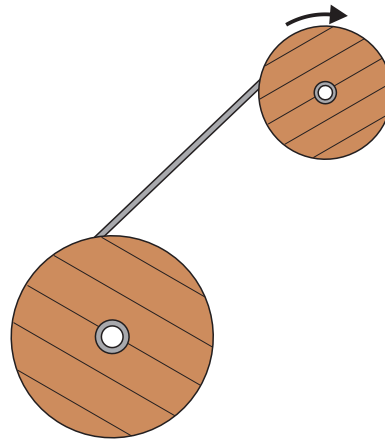

Corretto / Correct

Durante lo svolgimento del cavo è necessario mantenere una direzione più rettilinea possibile e senza torsioni; al termine il cavo deve essere bloccato senza torsioni residue. I cavi non devono essere mai srotolati dalla flangia del tamburo, ciò potrebbe causare danni al cavo.

During unwinding, a straight torsion-free guiding has to be observed and the cable has to be fixed and connected torsion-free. Cables must never be unwound off over the drum flange, this will causes kinks and may results in cable damages.

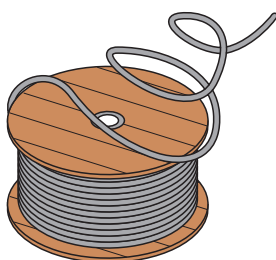

Non corretto / Wrong

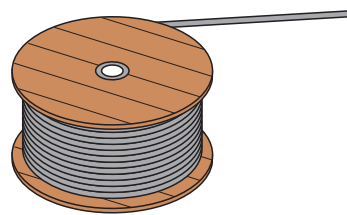

Corretto / Correct

0.3 Impiego dei cavi in catena portacavi Use of cables in drag-chain

Per applicazioni dinamiche, è possibile utilizzare cavi appositamente progettati per catena portacavi. Una catena portacavi è un sistema progettato per trasportare, proteggere e guidare cavi di potenza, controllo e segnale, tubi idraulici o pneumatici per trasferire potenza e segnale tra due punti in movimento relativo tra loro (traslazione, rotazione o entrambi).

Le seguenti istruzioni sono suggerite per una corretta installazione dei cavi nella catena portacavi.

For dynamic applications, cables in drag-chain (also called energy chain, cable track, cable carrier) can be used. A drag-chain is a mechanical system designed to carry, protect and guide power, control, signal cables and hydraulic or pneumatic hoses in dynamic applications to transfer power and signal between two points in relative movement (translation, rotation or both) to each other.

Following instructions are suggested for a proper installation of cables in drag-chain.

- I cavi devono essere selezionati con estrema attenzione. Utilizzare sempre solo cavi adatti per l'applicazione specifica in catena portacavi.
- I cavi devono essere conservati in aree al coperto e all'interno dell'intervallo di temperatura indicato nella scheda tecnica. La temperatura del cavo non deve essere inferiore a +5 °C durante l'installazione.
- Il raggio di curvatura minimo R deve essere sempre rispettato. Il cavo con il diametro maggiore deve essere utilizzato per dimensionare il raggio di curvatura minimo della catena portacavi.
- *The cables must be selected extremely carefully. Always use only cables which are suitable for the specific drag-chain application.*
- *Cables should be stored in closed space and within the temperature range given in the technical datasheet. The cable temperature should not be below +5°C during installation.*
- *The minimum bending radius R must always be respected. The cable with the largest diameter must be used for dimensioning the minimum bending radius of the drag-chain.*

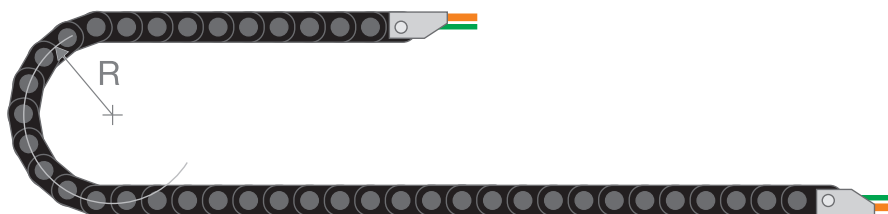

- La sezione utile totale della catena portacavi deve essere riempita non più dell'80%. Lasciare uno spazio libero attorno al cavo di almeno il 10% del diametro.
- *The total cross-section of the drag-chain should be filled not more than 80%. Allow a free space around the cable of at least 10% of the diameter.*

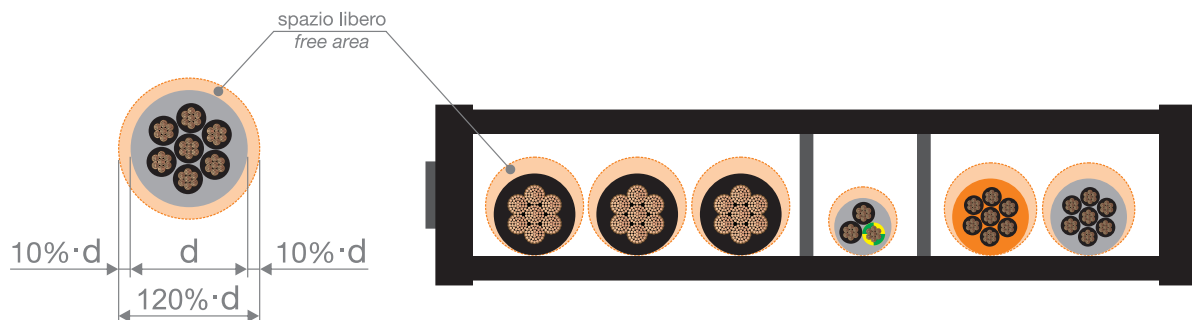

- I cavi non devono accavallarsi l'un l'altro e non devono essere posizionati sopra gli altri. La posa su singolo strato dovrebbe essere preferita rispetto alla disposizione multistrato, in questi casi si suggerisce l'uso di barre di divisione tra gli strati. Cavi con diametri, materiale della guaina o del conduttore diversi devono essere installati separatamente con barre divisorie (separatori). Se ciò non fosse possibile, è opportuno verificare che lo spazio interno della catena portacavi non consenta l'accavallamento dei cavi ($H < d1 + d2$).
- *The cable must not cross another and must not be placed on top of another. Single layer of cables should be preferred over multi-layer arrangement. Dividing bars should be installed between the layers of multi-layer cable arrangement. Cables with different diameters, jacket material or conducting material should be installed separately with dividing bars (separators). If this is not possible verify that the internal space of the drag-chain does not allow cables to be twisted ($H < d1 + d2$).*

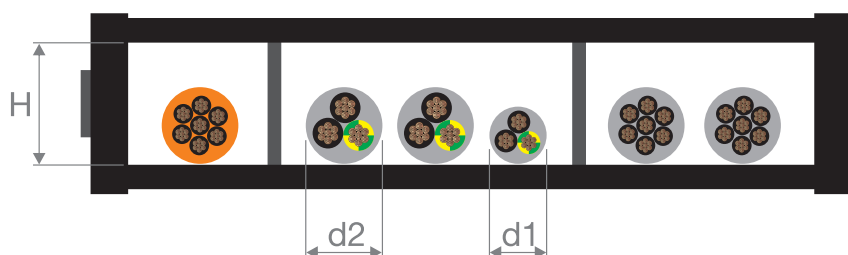

- I cavi devono potersi muovere liberamente anche attorno al raggio di curvatura della catena portacavi. I cavi non devono mai essere fissati o legati insieme nella catena.
 - I cavi devono essere posati in catene portacavi senza indurre sollecitazioni di tensione o torsione. Si consiglia di posare i cavi liberi a terra o, meglio, appenderli prima dell'uso per liberarli da ogni possibile torsione.
 - Prima e dopo il fissaggio dei cavi, si consiglia di far funzionare la catena portacavi per alcuni cicli al fine di verificare il libero movimento dei cavi e gli spazi attorno ad essi.
 - È necessario garantire una certa quantità di cavo libero (riserva) su entrambe le estremità della catena portacavi. Evitare di mantenere il movimento fino all'utenza e installare i dispositivi di fissaggio per cavi (serracavi, fascette, profili di fissaggio) sia all'estremità mobile sia nel punto fisso.
 - Verificare periodicamente i cavi controllando eventuali accavallamenti, torsioni o tensioni. Sostituire tutti i cavi nel caso in cui la catena portacavi sia danneggiata.
- Cables must be able to move freely also around the bending radius. The cables must never be fixed or tied together in the chain.
 - Cables must be laid in drag chains without any inducted torsion (twisting) or load. It is suggested to lay or, better, hang the cables before use in order to release any possible twist.
 - Before and after fixing cables, it is suggested to operate the drag-chain for few cycles in order to verify free movements, spaces around the cables and to bring the cables in a neutral position.
 - A certain amount of loose cable (reserve) must be guaranteed on both ends of the drag-chain. Avoid keeping the movement up to the utility. Install cable fixation devices (cable clamps, cable ties, fixation profiles) at the moving end and at the fixed point.
 - Verify periodically the cables: check overlaps, torsions or stretching. Replace all the cables after failure of a drag-chain.

Le configurazioni della catena portacavi dipendono dalla distanza percorsa, dal peso contenuto, dal tipo di catena portacavi e dalla applicazione.
The drag-chain configurations are depending on the travel distance, the fill weight, the drag-chain type and the applications.

Autoportante (unsupported o self-supported).

Quando la parte superiore della catena portacavi si muove senza toccare la parte inferiore lungo l'intera corsa. Questa configurazione consente una maggiore velocità e accelerazione e meno stress per cavi e catene portacavi, la durata di vita prevista della catena è maggiore.

Unsupported (or self-supported).

When the upper run of the drag-chain operates without touching the lower run along the entire travel. This configuration allow higher speed and acceleration and less cable and drag-chain stress, lifetime is longer.

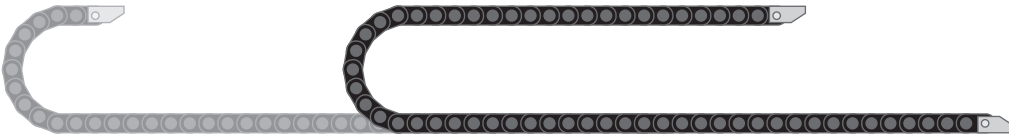

Autoportante con flessione unsupported o self-supported with sag.

Quando la parte superiore della catena portacavi si muove soggetta ad una flessione che tende ad abbassarla. Questa configurazione consente distanze di percorrenza più lunghe ma deve essere utilizzata con velocità e accelerazione inferiori e la durata di vita prevista della catena è ridotta.

Unsupported with sag (or self-supported with sag).

When the upper run of the drag-chain operates with a sag. This configuration allow longer travel distances but must be operated with lower speed and acceleration and the lifetime is reduced.

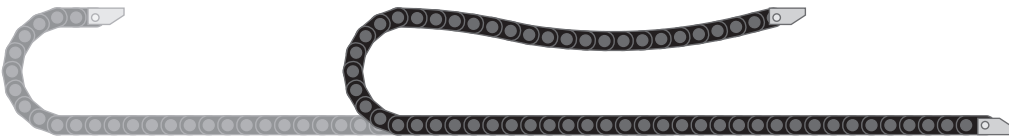

Scorrimento.

Nel caso di corse elevate, la parte superiore della catena portacavi scorre sulla sua parte inferiore. Oltre il punto fisso, la catena portacavi deve scorrere sulla superficie di scorrimento di un canale di guida, necessario anche per evitare che la parte superiore sia soggetta a spostamenti laterali rispetto alla parte inferiore.

Gliding (or sliding).

In the case of long travel lengths, the upper run of the drag-chain glides on its lower run. Beyond the fixed point the drag-chain glides on the sliding surface (support) of the guide channel which is required to prevent the upper run from slipping off the lower run.

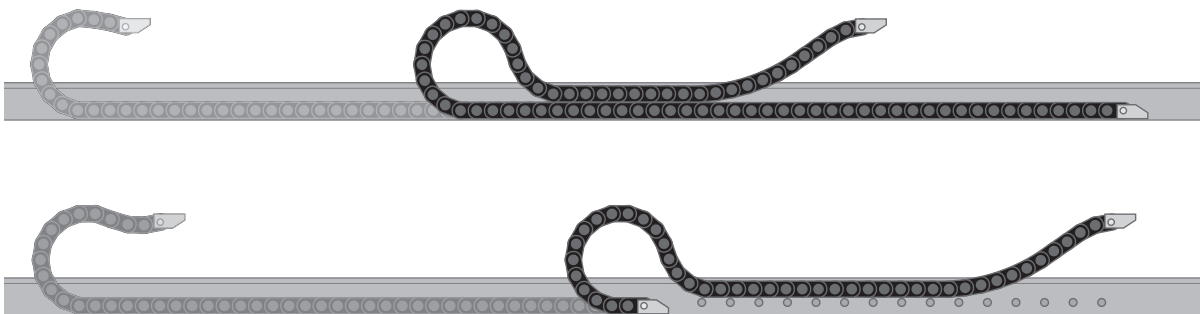

Appendice P. Tabelle colore

Appendix P. Tables of Color

P.1 Distinzione conduttori in relazione alla funzione Colors of conductors according to their function

Tabella P.1. Colori dei conduttori in relazione alla funzione

Table P.1. Colors of conductors according to their function

Funzione <i>Function</i>	Codifica internazionale <i>International codification</i>	Codifica Nord America <i>North American codification</i>
N-Neutral (Neutral)	Blu chiaro <i>Light blue</i>	Bianco <i>White</i>
L-Live (Phase)	Marrone <i>Brown</i>	Nero <i>Black</i>
E-Earth or Ground	Giallo/Verde <i>Yellow/Green</i>	Verde o Giallo/Verde <i>Green or Yellow /Green</i>

P.2 Distinzione conduttori secondo DIN 47100 Colors of conductors according to DIN 47100

Tabella P.2a. Distinzione conduttori secondo DIN 47100 - Cavi multipolari

Table P.2a. Colors of conductors according to DIN 47100 – Multicore cables

N° Conduttore <i>Conductor ID</i>	Colore <i>Color</i>
1	Bianco - <i>White</i>
2	Marrone - <i>Brown</i>
3	Verde - <i>Green</i>
4	Giallo - <i>Yellow</i>
5	Grigio - <i>Gray</i>
6	Rosa - <i>Pink</i>
7	Blu - <i>Blue</i>
8	Rosso - <i>Red</i>
9	Nero - <i>Black</i>
10	Viola - <i>Violet</i>
11	Grigio/Rosa - <i>Gray/Pink</i>
12	Rosso/Blu - <i>Red/Blue</i>
13	Bianco/Verde - <i>White/Green</i>
14	Marrone/Verde - <i>Brown/Green</i>
15	Bianco/Giallo - <i>White/Yellow</i>
16	Giallo/Marrone - <i>Yellow/Brown</i>
17	Bianco/Grigio - <i>White/Gray</i>
18	Grigio/Marrone - <i>Gray/Brown</i>
19	Bianco/Rosa - <i>White/Pink</i>
20	Rosa/Marrone - <i>Pink/Brown</i>
21	Bianco/Blu - <i>White/Blue</i>
22	Marrone/Blu - <i>Brown/Blue</i>
23	Bianco/Rosso - <i>White/Red</i>
24	Marrone/Rosso - <i>Brown/Red</i>
25	Bianco/Nero - <i>White/Black</i>
26	Marrone/Nero - <i>Brown/Black</i>
27	Grigio/Verde - <i>Gray/Green</i>
28	Giallo/Grigio - <i>Yellow/Gray</i>
29	Rosa/Verde - <i>Pink/Green</i>
30	Giallo/Rosa - <i>Yellow/Pink</i>
31	Verde/Blu - <i>Green/Blue</i>
32	Giallo/Blu - <i>Yellow/Blue</i>
33	Verde/Rosso - <i>Green/Red</i>

N° Conduttore Conductor ID	Colore Color
34	Giallo/Rosso - Yellow/Red
35	Verde/Nero - Green/Black
36	Giallo/Nero - Yellow/Black
37	Grigio/Blu - Gray/Blue
38	Rosa/Blu - Pink/Blue
39	Grigio/Rosso - Gray/Red
40	Rosa/Rosso - Pink/Red
41	Grigio/Nero - Gray/Black
42	Rosa/Nero - Pink/Black
43	Blu/Nero - Blue/Black
44	Rosso/Nero - Red/Black

Tabella P.2b. Distinzione conduttori secondo DIN 47100 - Cavi multipolari a coppie
Table P.2b. Colors of conductors according to DIN 47100 – Muticore cables in pairs

N° Coppia Pairs ID	Colore conduttore 1 Conductor 1 color	Colore conduttore 2 Conductor 2 color
1	Bianco - White	Marrone - Brown
2	Verde - Green	Giallo - Yellow
3	Grigio - Gray	Rosa - Pink
4	Blu - Blue	Rosso - Red
5	Nero - Black	Viola - Violet
6	Grigio/Rosa - Gray/Pink	Rosso/Blu - Red/Blue
7	Bianco/Verde - White/Green	Marrone/Verde - Brown/Green
8	Bianco/Giallo - White/Yellow	Giallo/Marrone - Yellow/Brown
9	Bianco/Grigio - White/Gray	Grigio/Marrone - Gray/Brown
10	Bianco/Rosa - White/Pink	Rosa/Marrone - Pink/Brown
11	Bianco/Blu - White/Blue	Marrone/Blu - Brown/Blue
12	Bianco/Rosso - White/Red	Marrone/Rosso - Brown/Red
13	Bianco/Nero - White/Black	Marrone/Nero - Brown/Black
14	Grigio/Verde - Gray/Green	Giallo/Grigio - Yellow/Gray
15	Rosa/Verde - Pink/Green	Giallo/Rosa - Yellow/Pink
16	Verde/Blu - Green/Blue	Giallo/Blu - Yellow/Blue
17	Verde/Rosso - Green/Red	Giallo/Rosso - Yellow/Red
18	Verde/Nero - Green/Black	Giallo/Nero - Yellow/Black
19	Grigio/Blu - Gray/Blue	Rosa/Blu - Pink/Blue
20	Grigio/Rosso - Gray/Red	Rosa/Rosso - Pink/Red
21	Grigio/Nero - Gray/Black	Rosa/Nero - Pink/Black
22	Blu/Nero - Blue/Black	Rosso/Nero - Red/Black

P.3 Distinzione conduttori secondo CEI UNEL 00722 Colors of conductors according to CEI UNEL 00722

Tabella P.3a. Distinzione conduttori secondo CEI UNEL 00722:2002 - Cavi multipolari senza conduttore Giallo/Verde
Table P.3a. Colors of conductors according to CEI UNEL 00722:2002 – Muticore cables without Yellow/Green conductor

N° Conduttori Num. of conductors	Conduttore 1 Conductor 1	Conduttore 2 Conductor 2	Conduttore 3 Conductor 3	Conduttore 4 Conductor 4	Conduttore 5 Conductor 5	Conduttore 6÷n Conductor 6÷n
2	Blu - Blue	Marrone - Brown				
3	Marrone - Brown	Nero - Black	Grigio - Gray			
4	Blu - Blue	Marrone - Brown	Nero - Black	Grigio - Gray		
5	Blu - Blue	Marrone - Brown	Nero - Black	Grigio - Gray	Nero - Black	
>5						Neri numerati - Black numbered

Tabella P.3b. Distinzione conduttori secondo CEI UNEL 00722:2002 - Cavi multipolari con conduttore Giallo/Verde
 Table P.3b. Colors of conductors according to CEI UNEL 00722:2002 – Multicore cables with Yellow/Green conductor

N° Conduttori Num. of conductors	Conduttore 1 Conductor 1	Conduttore 2 Conductor 2	Conduttore 3 Conductor 3	Conduttore 4 Conductor 4	Conduttore 5 Conductor 5	Conduttore 6÷n Conductor 6÷n
3	Giallo/Verde - Yellow/Green	Blu - Blue	Marrone - Brown			
4	Giallo/Verde - Yellow/Green	Marrone - Brown	Nero - Black	Grigio - Gray		
5	Giallo/Verde - Yellow/Green	Blu - Blue	Marrone - Brown	Nero - Black	Grigio - Gray	
>5	Neri numerati + Giallo/Verde - Black numbered + Yellow/Green					

P.4 Distinzione conduttori secondo UL508a Colors of conductors according to UL508a

Tabella P.4a. Tabella colori secondo UL 508a - Rev. 2007-2018, requisiti per tutti i tipi di quadri elettrici (17.3 Identification of Grounding and Grounded Circuit Conductors and Terminals)
 Table P.4a. Colors of conductors according to UL 508a - Rev. 2007-2018, requirements for all kind of control panels (17.3 Identification of Grounding and Grounded Circuit Conductors and Terminals)

Colore Color	Funzione Function
Verde (o giallo/verde) Green (or Yellow/Green)	Conduttore di terra Ground conductor

Tabella P.4b. Tabella colori secondo UL 508a - Rev. 2007-2018, requisiti per i conduttori di potenza di quadri elettrici (66.5 Internal wiring - power circuits)
 Table P.4b. Colors of conductors according to UL 508a - Rev. 2007-2018, requirements for power circuit conductors of control panels (66.5 Internal wiring - power circuits)

Colore Color	Funzione Function
Nero Black	Conduttori non di terra Ungrounded power circuit conductors
Bianco o Grigio o con tre strisce bianche su colorazioni diverse dal verde, blu, arancione o giallo White or gray or three continuous white stripes on other than green, blue, orange or yellow	Conduttori di terra in corrente alternata Grounded alternate current power circuit conductors

Tabella P.4c. Tabella colori secondo UL 508a - Rev. 2007-2018, requisiti per i conduttori di comando e controllo di quadri elettrici (66.9 Internal wiring of control circuit)
 Table P.4c. Colors of conductors according to UL 508a - Rev. 2007-2018, requirements for control circuit conductors of control panels (66.9 Internal wiring of control circuit)

Colore Color	Funzione Function
Nero Black	Conduttori non di terra alimentati con tensione nominale di alimentazione All ungrounded control circuit conductors operating at the supply voltage
Rosso Red	Conduttori non di terra in corrente alternata alimentati con tensione inferiore alla tensione nominale di alimentazione Ungrounded alternate current control circuits operating at a voltage less than the supply voltage
Blu Blue	Conduttori non di terra in corrente continua Ungrounded direct current control circuit conductor
Giallo o Arancione Yellow or Orange	Conduttori non di terra che rimangono alimentati anche quando il sezionatore generale è in posizione "off" (circuiti a monte del sezionatore generale) Ungrounded control circuits or other wiring, such as for cabinet lighting, that remain energized when the main disconnect is in the "off" position.
Bianco o Grigio o con tre strisce bianche su colorazioni diverse dal verde, blu, arancione o giallo White or gray or three white stripes on other than green, blue, orange or yellow	Conduttore di terra di circuiti in corrente alternata Grounded alternate current control circuit conductor
Bianco con strisce blu White with blue stripe	Conduttore di terra di circuiti in corrente continua Grounded direct current control circuit conductor

P.5 Distinzione conduttori secondo NFPA 79 Colors of conductors according to NFPA 79

Tabella P.5. Tabella colori secondo NFPA 79 - Ed. 2007-2018 - 13.2 Identification of Conductors
Table P.5. Colors of conductors according to NFPA 79 - Ed. 2007-2018 - 13.2 Identification of Conductors

Colore <i>Color</i>	Funzione <i>Function</i>
Nero <i>Black</i>	Conduttori di potenza <i>Ungrounded alternate and direct current power conductors</i>
Rosso <i>Red</i>	Conduttori di comando e controllo in corrente alternata <i>Ungrounded alternate current control circuit conductors</i>
Blu <i>Blue</i>	Conduttori di comando e controllo in corrente continua <i>Ungrounded direct current control circuit conductors</i>
Arancione <i>Orange</i>	Conduttori non di terra che rimangono alimentati anche quando il sezionatore generale è in posizione "off" (circuiti a monte del sezionatore generale) <i>Ungrounded conductors that remain energized when the main supply circuit disconnecting means is in the "off" position</i>
Verde (o giallo/verde) <i>Green (or Yellow/Green)</i>	Conduttore di terra <i>Grounded conductors</i>
Bianco con strisce arancioni <i>White with orange stripes</i>	Conduttore di terra che rimane alimentato anche quando il sezionatore generale è in posizione "off" (circuiti a monte del sezionatore generale) <i>Grounded alternate current circuit conductors that remain energized when the main supply circuit disconnecting means is in the "off" position</i>
Bianco o Grigio o con tre strisce bianche su colorazioni diverse dal verde, blu, arancione <i>White or gray or three white stripes on other than green, blue or orange</i>	Conduttore di terra di circuiti in corrente alternata <i>Grounded alternate current control circuit conductor</i>
Bianco con strisce blu <i>White with blue stripe</i>	Conduttore di terra di circuiti in corrente continua <i>Grounded direct current control circuit conductor</i>

P.6 Distinzione conduttori secondo EN 60204-1 Colors of conductors according to EN 60204-1

Tabella P.6. Tabella colori secondo IEC 60204-1:2016
Table P.6. Colors of conductors according to IEC 60204-1:2016

Colore <i>Color</i>	Funzione <i>Function</i>
Nero <i>Black</i>	Conduttori di potenza in corrente alternata ed in corrente continua <i>Ungrounded alternate and direct current power conductors</i>
Rosso <i>Red</i>	Conduttori di comando e controllo in corrente alternata <i>Ungrounded alternate current control circuit conductors</i>
Blu <i>Blue</i>	Conduttori di comando e controllo in corrente continua <i>Ungrounded direct current control circuit conductors</i>
Giallo/verde <i>Yellow/Green</i>	Conduttore di terra <i>Grounded conductors</i>

P.7 Distinzione conduttori secondo ICEA (Insulated Cable Engineers Association) Colors of conductors according to ICEA (Insulated Cable Engineers Association)

Tabella P.7a. Tabella colori ICEA (Insulated Cable Engineers Association) – Metodo 1, tabella E-1

Table P.7a. Colors of conductors according to ICEA (Insulated Cable Engineers Association) – Method 1, table E-1

Conduttore Conductor ID	Colore Color	Conduttore Conductor ID	Colore Color	Conduttore Conductor ID	Colore Color	Conduttore Conductor ID	Colore Color	Conduttore Conductor ID	Colore Color
1	Nero Black	11	Blu/nero Blue/black	21	Arancione/verde Orange/green	31	Verde/nero/arancione Green/black/orange	41	Verde/bianco/blu Green/white/blue
2	Bianco White	12	Nero/bianco Black/white	22	Nero/bianco/rosso Black/white/red	32	Arancione/nero/verde Orange/black/green	42	Arancio/rosso/verde Orange/red/green
3	Rosso Red	13	Rosso/bianco Red/white	23	Bianco/nero/rosso White/black/red	33	Blu/bianco/arancione Blue/white/orange	43	Blu/rosso/verde Blue/red/green
4	Verde Green	14	Verde/bianco Green/white	24	Rosso/nero/bianco Red/black/white	34	Nero/bianco/arancione Black/white/orange	44	Nero/bianco/blu Black/white/blue
5	Arancione Orange	15	Blu/bianco Blue/white	25	Verde/nero/bianco Green/black/white	35	Bianco/rosso/arancione White/red/orange	45	Bianco/nero/blu White/black/blue
6	Blu Blue	16	Nero/rosso Black/red	26	Arancione/nero/bianco Orange/black/white	36	Arancione/bianco/blu Orange/white/blue	46	Rosso/bianco/blu Red/white/blue
7	Bianco/nero White/Black	17	Bianco/rosso White/red	27	Blu/nero/bianco Blue/black/white	37	Bianco/rosso/blu White/red/blue	47	Verde/arancione/rosso Green/orange/red
8	Rosso/nero Red/Black	18	Arancione/ rosso Orange/red	28	Nero/rosso/verde Black/red/green	38	Nero/bianco/verde Black/white/green	48	Arancione/rosso/blu Orange/red/blue
9	Verde/nero Green/Black	19	Blu/rosso Blue/red	29	Bianco/rosso/verde White/red/green	39	Bianco/nero/verde White/black/green	49	Blu/arancione/rosso Blue/orange/red
10	Arancione/nero Orange/Black	20	Rosso/verde Red/green	30	Rosso/nero/verde Red/black/green	40	Rosso/bianco/verde Red/white/green	50	Nero/arancione/rosso Black/orange/red

Tabella P.7b. Tabella colori ICEA (Insulated Cable Engineers Association) – Metodo 1, tabella E-2

Table P.7b. Colors of conductors according to ICEA (Insulated Cable Engineers Association) – Method 1, table E-2

Conduttore Conductor ID	Colore Color	Conduttore Wire	Colore Color
1	Nero - Black	17	Nero/blu - Black/Blue
2	Rosso - Red	18	Rosso/blu - Red/Blue
3	Blu - Blue	19	Arancione/blu - Orange/blue
4	Arancione - Orange	20	Giallo/blu - Yellow/blue
5	Giallo - Yellow	21	Marrone/blu - Brown/blue
6	Marrone - Brown	22	Nero/arancione - Black/orange
7	Rosso/nero - Red/Black	23	Rosso/arancione - Red/orange
8	Blu/nero - Blue/Black	24	Blu/arancione - Blue/orange
9	Arancione/nero - Orange/Black	25	Giallo/arancione - Yellow/orange
10	Giallo/nero - Yellow/Black	26	Marrone/arancione - Brown/orange
11	Marrone/nero - Brown/Red	27	Nero/giallo - Black/yellow
12	Nero/rosso - Black/Red	28	Rosso/giallo - Red/yellow
13	Blu/rosso - Blue/Red	29	Blu/giallo - Blue/yellow
14	Arancione/rosso - Orange/Red	30	Arancione/giallo - Orange/yellow
15	Giallo/rosso - Yellow/Red	31	Marrone/giallo - Brown/yellow
16	Marrone/rosso - Brown/Red	32	Nero/marrone - Black/brown

P.8 Distinzione conduttori secondo specifica interna Tipo 1-P
 Colors of conductors according to internal specification Type 1-P

Tabella P.8. Distinzione delle coppie
 Table P.8. Colors of pairs

N° Coppia Pair ID	Conduttore 1 Conductor 1	Conduttore 2 Conductor 2
1	Bianco - <i>White</i>	Blu - <i>Blue</i>
2	Bianco - <i>White</i>	Arancione - <i>Orange</i>
3	Bianco - <i>White</i>	Verde - <i>Green</i>
4	Bianco - <i>White</i>	Nero - <i>Black</i>
5	Bianco - <i>White</i>	Rosso - <i>Red</i>
6	Bianco - <i>White</i>	Grigio - <i>Gray</i>
7	Bianco - <i>White</i>	Marrone - <i>Brown</i>
8	Bianco - <i>White</i>	Giallo - <i>Yellow</i>

P.9 Distinzione conduttori secondo specifica interna Tipo 1-C
 Colors of conductors according to internal specification Type 1-C

Tabella P.9. Distinzione delle coppie
 Table P.9. Colors of pairs

N° Coppia Pair ID	Conduttore 1 Conductor 1	Conduttore 2 Conductor 2
1	Nero - <i>Black</i>	Rosso - <i>Red</i>
2	Nero - <i>Black</i>	Bianco - <i>White</i>
3	Nero - <i>Black</i>	Verde - <i>Green</i>
4	Nero - <i>Black</i>	Blu - <i>Blue</i>
5	Nero - <i>Black</i>	Giallo - <i>Yellow</i>
6	Nero - <i>Black</i>	Marrone - <i>Brown</i>

P.10 Distinzione conduttori secondo specifica interna Tipo 1-T
 Colors of conductors according to internal specification Type 1-T

Tabella P.10. Distinzione delle coppie
 Table P.10. Colors of pairs

N° Coppia Pair ID	Conduttore 1 Conductor 1	Conduttore 2 Conductor 2
1	Giallo - <i>Yellow</i>	Blu - <i>Blue</i>
2	Rosso/Bianco - <i>Red/white</i>	Nero/Bianco - <i>Black/white</i>
3	Rosso - <i>Red</i>	Nero - <i>Black</i>
4	Bianco - <i>White</i>	Blu - <i>Blue</i>
5	Rosso - <i>Red</i>	Bianco - <i>White</i>
6	Rosso/Bianco - <i>Red/white</i>	Bianco - <i>White</i>

P.11 Distinzione conduttori secondo specifica interna Tipo 2-C

Colors of conductors according to internal specification Type 2-C

Tabella P.11a. Distinzione delle coppie 0,35 mm²

Table P.11a. Colors of pairs 0,35 mm²

N° Coppia Pair ID	Conduttore 1 Conductor 1	Conduttore 2 Conductor 2
1	Giallo - <i>Yellow</i>	Rosa - <i>Pink</i>
2	Bianco - <i>White</i>	Blu - <i>Blue</i>
3	Viola - <i>Violet</i>	Marrone - <i>Brown</i>

Tabella P.11b. Distinzione delle coppie 0,5 mm²

Table P.11b. Colors of pairs 0,5 mm²

N° Coppia Pair ID	Conduttore 1 Conductor 1	Conduttore 2 Conductor 2
1	Rosso - <i>Red</i>	Nero - <i>Black</i>

P.12 Distinzione conduttori secondo specifica interna Tipo 3-P

Colors of conductors according to internal specification Type 3-P

Tabella P.12a. Distinzione delle coppie

Table P.12a. Colors of pairs

N° Coppia Pair ID	Conduttore 1 Conductor 1	Conduttore 2 Conductor 2
1	Verde - <i>Green</i>	Bianco/Verde - <i>White/green</i>
2	Blu - <i>Blue</i>	Bianco/Blu - <i>White/blu</i>
3	Arancione - <i>Orange</i>	Bianco/Arancione - <i>White/orange</i>

Tabella P.12b. Distinzione dei conduttori

Table P.12b. Colors of conductors

N° Conduttore Conductor ID	Colore Color
1	Rosso - <i>Red</i>
2	Nero - <i>Black</i>
3	Giallo/Verde - <i>Yellow/green</i>

P.13 Distinzione conduttori secondo specifica interna Tipo 4-C

Colors of conductors according to internal specification Type 4-C

Tabella P.13a. Distinzione delle coppie 0,25 mm²

Table P.13a. Colors of pairs 0,25 mm²

N° Coppia Pair ID	Conduttore 1 Conductor 1	Conduttore 2 Conductor 2
1	Marrone - <i>Brown</i>	Verde - <i>Green</i>
2	Grigio - <i>Gray</i>	Rosa - <i>Pink</i>
3	Blu - <i>Blue</i>	Viola - <i>Violet</i>
4	Rosso - <i>Red</i>	Nero - <i>Black</i>

Tabella P.13b. Distinzione delle coppie 1 mm²

Table P.13b. Colors of pairs 1 mm²

N° Coppia Pair ID	Conduttore 1 Conductor 1	Conduttore 2 Conductor 2
1	Bianco - <i>White</i>	Marrone - <i>Brown</i>

P.14 Distinzione conduttori secondo specifica interna Tipo 5-P Colors of conductors according to internal specification Type 5-P

Tabella P.14a. Distinzione delle coppie

Table P.14a. Colors of pairs

N° Coppia Pair ID	Conduttore 1 Conductor 1	Conduttore 2 Conductor 2
1	Rosso - <i>Red</i>	Arancione - <i>Orange</i>
2	Giallo - <i>Yellow</i>	Verde - <i>Green</i>
3	Blu - <i>Blue</i>	Viola - <i>Violet</i>
4	Marrone - <i>Brown</i>	Nero - <i>Black</i>

Tabella P.14b. Distinzione dei conduttori

Table P.14b. Colors of conductors

N° Conduttore Pair ID	Colore Color
1	Bianco/Blu - <i>White/blue</i>
2	Bianco/Rosso - <i>White/red</i>
3	Bianco/Nero - <i>White/black</i>
4	Bianco/Giallo - <i>White/Yellow</i>

P.15 Distinzione conduttori secondo specifica interna Tipo 6-T Colors of conductors according to internal specification Type 6-T

Tabella P.15a. Distinzione delle coppie

Table P.15a. Colors of pairs

N° Coppia Pair ID	Conduttore 1 Conductor 1	Conduttore 2 Conductor 2
1	Bianco - <i>White</i>	Giallo - <i>Yellow</i>
2	Bianco - <i>White</i>	Blu - <i>Blue</i>
3	Bianco - <i>White</i>	Rosso - <i>Rosso</i>
4	Bianco - <i>White</i>	Verde - <i>Green</i>

P.16 Distinzione conduttori secondo specifica interna Tipo 7-P

Colors of conductors according to internal specification Type 7-P

Tabella P.16a. Distinzione delle coppie

Table P.16a. Colors of pairs

N° Coppia Pair ID	Conduttore 1 Conductor 1	Conduttore 2 Conductor 2
1	Blu - Blue	Nero - Black

Tabella P.16b. Distinzione dei conduttori

Table P.16b. Colors of conductors

N° Conduttore Conductor ID	Colore Color
1	Nero - Black
2	Viola - Violet
3	Rosa - Pink
4	Marrone - Brown
5	Verde - Green
6	Giallo - Yellow
7	Bianco - White
8	Blu - Blue

P.17 Distinzione conduttori secondo specifica interna Tipo 8-C

Colors of conductors according to internal specification Type 8-C

Tabella P.17a. Distinzione delle coppie 0,14 mm²

Table P.17a. Colors of pairs 0,14 mm²

N° Coppia Pair ID	Conduttore 1 Conductor 1	Conduttore 2 Conductor 2
1	Verde - Green	Giallo - Yellow
2	Nero - Black	Marrone - Brown
3	Grigio - Gray	Rosa - Pink

Tabella P.17b. Distinzione delle coppie 0,5 mm²

Table P.17b. Colors of pairs 0,5 mm²

N° Coppia Pair ID	Conduttore 1 Conductor 1	Conduttore 2 Conductor 2
1	Bianco - White	Marrone - Brown

P.18 Distinzione conduttori secondo specifica interna Tipo 9-P

Colors of conductors according to internal specification Type 9-P

Tabella P.18a. Distinzione delle coppie 0,14 mm²

Table P.18a. Colors of pairs 0,14 mm²

N° Coppia Pair ID	Conduttore 1 Conductor 1	Conduttore 2 Conductor 2
1	Giallo - Yellow	Verde - Green
2	Nero - Black	Marrone - Brown
3	Rosso - Red	Arancione - Orange

Tabella P.18b. Distinzione delle coppie 0,5 mm²

Table P.18b. Colors of pairs 0,5 mm²

N° Coppia Pair ID	Conduttore 1 Conductor 1	Conduttore 2 Conductor 2
1	Marrone/Blu - Brown/blu	Marrone/Rosso - Brown/red

Tabella P.18c. Distinzione delle coppie 0,14 mm²

Table P.18c. Colors of pairs 0,14 mm²

N° Coppia Pair ID	Conduttore 1 Conductor 1	Conduttore 2 Conductor 2
1	Grigio - Gray	Bianco/Giallo - White/yellow
2	Blu - Blue	Bianco/Nero - White/black

Tabella P.18d. Distinzione delle coppie 0,25 mm²

Table P.18d. Colors of pairs 0,25 mm²

N° Coppia Pair ID	Conduttore 1 Conductor 1	Conduttore 2 Conductor 2
1	Marrone/Giallo - Brown/yellow	Verde/Nero - Green/black
2	Marrone/Grigio - Brown/Gray	Verde/Rosso - Green/red

P.19 Distinzione conduttori secondo specifica interna Tipo 10-P

Colors of conductors according to internal specification Type 10-P

Tabella P.19. Distinzione delle coppie

Table P.19. Colors of pairs

N° Coppia Pair ID	Conduttore 1 Conductor 1	Conduttore 2 Conductor 2
1	Nero - Black	Verde - Green
2	Rosso - Red	Blu - Blue

P.20 Distinzione conduttori secondo HD 308 S2

Colors of conductors according to HD 308 S2

Tabella P.20a. Tabella colori di cavi in presenza di conduttore giallo/verde HD 308 S2

Table P.20a. Color of conductors with yellow/green conductor according to HD 308 S2

N° Conduttori Num. of conductors	Conduttore 1 Conductor 1	Conduttore 2 Conductor 2	Conduttore 3 Conductor 3	Conduttore 4 Conductor 4	Conduttore 5 Conductor 5
3	Giallo/Verde - Yellow/Green	Blu - Blue	Marrone - Brown	-	-
4	Giallo/Verde - Yellow/Green	Marrone - Brown	Nero - Black	Grigio - Gray	-
4*	Giallo/Verde - Yellow/Green	Blu - Blue	Marrone - Brown	Nero - Black	-
5	Giallo/Verde - Yellow/Green	Blu - Blue	Marrone - Brown	Nero - Black	Grigio - Gray

* Colorazione per applicazioni particolari.

* For certain applications.

Tabella P.20a. Tabella colori di cavi in presenza di conduttore giallo/verde HD 308 S2

Table P.20a. Color of conductors with yellow/green conductor according to HD 308 S2

N° Conduttori Num. of conductors	Conduttore 1 Conductor 1	Conduttore 2 Conductor 2	Conduttore 3 Conductor 3	Conduttore 4 Conductor 4	Conduttore 5 Conductor 5
2	Blu - Blue	Marrone - Brown	-	-	-
3	Marrone - Brown	Nero - Black	Grigio - Gray	-	-
3*	Blu - Blue	Marrone - Brown	Nero - Black	-	-
4	Blu - Blue	Marrone - Brown	Nero - Black	Grigio - Gray	-
5	Blu - Blue	Marrone - Brown	Nero - Black	Grigio - Gray	Nero - Black

* Colorazione per applicazioni particolari.

* For certain applications.

Appendice Q. Riferimenti normativi

Appendix Q. Standard reference

Tabella Q1. Elenco delle principali normative di riferimento

Table Q1. List of the main references standards

Norma Standard	Descrizione Description
ANSI C37.20	Switch gear assemblies and metal-enclosed bus
ANSI C80.1	Electrical Rigid Steel Conduit (ERSC)
ANSI C80.3	Steel Electrical Metallic Tubing (EMT)
ANSI C80.6	Electrical Intermediate Metal Conduit (EIMC)
ANSI Z535-4	Product Safety Signs and Labels
ANSI/NFPA 70	National Electrical Code
ANSI/NFPA 79	Electrical Standard for Industrial Machinery
ASTM A123/123M	Standard Specification for Zinc (Hot-Dip Galvanized) Coatings on Iron and Steel Products
ASTM-D 1000	Standard Test Method for Pressure-Sensitive Adhesive-Coated Tapes Used for Electrical and Electronic Applications
ASTM-D 149	Standard Test Method for Dielectric Breakdown Voltage and Dielectric Strength of Solid Electrical Insulating Materials at Commercial Power Frequencies
ASTM-D 150	Standard Test Methods for AC Loss Characteristics and Permittivity (Dielectric Constant) of Solid Electrical Insulation
ASTM-D 2303	Standard Test Methods for Liquid-Contaminant, Inclined-Plane Tracking and Erosion of Insulating Materials
ASTM-D 257	Standard Test Methods for DC Resistance or Conductance of Insulating Materials
ASTM-D 2671	Standard Test Methods for Heat-Shrinkable Tubing for Electrical Use
ASTM-D 412	Standard Test Methods for Vulcanized Rubber and Thermoplastic Elastomers-Tension
ASTM-D 570	Standard Test Method for Water Absorption of Plastics
ASTM-D 635	Standard Test Method for Rate of Burning and/or Extent and Time of Burning of Plastics in a Horizontal Position
ASTM-D 638	Standard Test Method for Tensile Properties of Plastics
ASTM-D 792	Standard Test Methods for Density and Specific Gravity (Relative Density) of Plastics by Displacement
ASTM-E 28	Standard Test Methods for Softening Point of Resins Derived from Naval Stores by Ring-and-Ball Apparatus
ASTM-G 21	Standard Practice for Determining Resistance of Synthetic Polymeric Materials to Fungi
ASTM-G 53	Practice for Operating Light- and Water-Exposure Apparatus (Fluorescent UV-Condensation Type) for Exposure of Nonmetallic Materials
CEI 15-26	Electrical insulation. Thermal evaluation and designation
CSA C22.2 No. 227.2.1-04	Liquid-Tight Flexible Nonmetallic Conduit
CSA C22.2 No. 227.3-05	Nonmetallic Mechanical Protection Tubing (NMPT)
CSA C22.2 No. 83.1-07	Electrical Metallic Tubing - Steel
CSA C22.2 No.126.1-09	Metal cable tray systems
DIN 40050	Road vehicles; degrees of protection (IP-code); protection against foreign objects; water and contact; electrical equipment
DIN 53474	Testing of plastics, rubber and elastomers - Determination of the chlorine content
EN 60228	Conductors of insulated cables
EN 60243	Electrical Strength of Insulating Materials – Test Methods
EN 60529	Specification for degrees of protection provided by enclosures (IP code)
EN 60707	Flammability of solid non-metallic materials when exposed to flame sources. List of test methods.
EN 61386	Conduit systems for cable management.
EN 61537	Cable management. Cable tray systems and cable ladder systems.
FMVSS 302	Flammability of Interior Materials - Passenger Cars, Multipurpose Passenger Vehicles, Trucks, and Buses
IEC 60684-2	Flexible insulating sleeving
ISO 180/1C	Plastics - Determination of Izod impact strength
ISO 37	Rubber, vulcanized or thermoplastic - Determination of tensile stress-strain properties
ISO 527	Determination of tensile properties
ISO R 1183	Plastics - Methods for determining the density and relative density (specific gravity) of plastics excluding cellular plastics
ISO R 527	Plastics - Determination of tensile properties
ISO-62	Plastics - Determination of water absorption
NEMA 250	Enclosures for Electrical Equipment (1000 Volts Maximum)
NEMA FB1	Fittings, Cast Metal Boxes, and Conduit Bodies for Conduit, Electrical Metallic Tubing, and Cable
NEMA VE 1	Metal Cable Tray Systems
NEMA VE 2	Cable Tray Installation Guidelines
NEMA WD-6	Locking Plugs and Receptacles
UL 1	Flexible Metal Conduit
UL 1063	Machine-Tool Wires and Cables
UL 1242	Electrical Intermediate Metal Conduit - Steel
UL 1563	Metal-Cald Cables

Norma Standard	Descrizione Description
UL 1581	Reference Standard for Electrical Wires, Cables, and Flexible Cords
UL 1598	Luminaires
UL 1660	Liquid-Tight Flexible Nonmetallic Conduit
UL 1685	Vertical-Tray Fire-Propagation and Smoke-Release Test for Electrical and Optical-Fiber Cables
UL 1696	Nonmetallic Mechanical Protection Tubing (NMPT)
UL 2225	Cables and Cable-Fittings For Use In Hazardous (Classified) Locations
UL 224	Extruded Insulating Tubing
UL 248-4	Low-Voltage Fuses - Part 4: Class CC Fuses
UL 248-6	Low-Voltage Fuses - Part 6: Class H Non-Renewable Fuses
UL 248-8	Low-Voltage Fuses - Part 8: Class J Fuses
UL 248-9	Low-Voltage Fuses - Part 9: Class K Fuses
UL 360	Liquid-Tight Flexible Metal Conduit
UL 4248-12	Fuseholders - Part 12: Class R
UL 4248-4	Fuseholders - Part 4: Class CC
UL 4248-6	Fuseholders - Part 6: Class H
UL 4248-8	Fuseholders - Part 8: Class J
UL 498	Attachment Plugs and Receptacles
UL 50	Enclosures for Electrical Equipment
UL 508	Industrial Control Equipment
UL 508A	Industrial Control Panels
UL 514B	Conduit, Tubing, and Cable Fittings
UL 6	Electrical Rigid Metal Conduit - Steel
UL 758	Appliance Wiring Material
UL 797	Electrical Metallic Tubing - Steel
UL 83	Thermoplastic-Insulated Wires and Cables
UL 886	Outlet Boxes and Fittings for Use in Hazardous (Classified) Locations
UL 94	Tests for Flammability of Plastic Materials for Parts in Devices and Appliances
UL 943	Ground-Fault Circuit-Interrupters
UL 969	Marking and Labeling Systems
VDE 0207	Insulating and sheathing compounds for cables and flexible cords; rubber insulating compound
VDE 0295	Conductors of cables, wires and flexible cords for power installation
VDE 0303	Electric strength of insulating materials
VDE 0472	Testing of cables, wires and flexible cords
VG 95343	Heat shrinkable components

Appendice R. Definizioni

Appendix R. Definitions

Tabella R.1. Sigle e definizioni

Table R.1. Abbreviations and definitions

Sigla <i>Abbreviation</i>	Definizione <i>Defintion</i>	Note/osservazioni/descrizioni <i>Remarks/description</i>
AHJs	Authorities Having Jurisdiction. An organization, office, or individual responsible for enforcing the requirements of a code or standard, or for approving equipment, materials, an installation, or a procedure.	
Ampacity	The maximum current, in amperes, that a conductor can carry continuously under the conditions of use without exceeding its temperature rating.	Vedi NEC. <i>See NEC.</i>
ANSI	American National Standards Institute	Istituto nazionale Americano di normazione <i>American National Standards Institute</i>
Appliance	A piece of utilization equipment that incorporates both controls and loads (rif. UL 508a).	
Attachment Plugs, Fuseless	This category covers adapters, appliance couplers, appliance and flatiron plugs, attachment plugs, cord connectors, male inlets (equipment inlets, motor attachment plugs), nonseparable attachment plugs, separable attachment plugs, shore power inlets and table taps. These devices do not incorporate switches or overcurrent protection.	
AWG	American Wire Gauge size	
AWM	Appliance Wiring Material, multitude of types and constructions for specific applications that may not meet specific or all UL requirements for a given type in a UL standard	
Branch circuit	The conductors and components following the last overcurrent protective device protecting a load (rif. UL 508a).	
Cable Sealing Fittings for Use in Hazardous Locations	This category covers combination termination and sealing fittings for threaded connection of cables to equipment in Class I, Division 1 and Division 2, and/or Class II, Division 1 and 2 hazardous locations, as indicated in the individual Listings. They are intended for use only with sealing compound as specified by the manufacturer in instructions furnished with the fitting. These devices are intended for use in sealing the conductors and outer jackets of Listed cables of the type indicated in the individual Listings. No splices of conductors are intended to be made in the fitting. Restrictions on position and/or location of the sealing fitting are indicated in the manufacturer's instructions.	
Cable Tray System	A unit or assembly of units or sections and associated fittings forming a structural system used to securely fasten or support cables and raceways.	Vedi NEC. <i>See NEC.</i>
Cable Tray, Ladder	A fabricated structure consisting of two longitudinal side rails connected by individual transverse members (rungs).	Vedi NEMA VE 2. <i>See NEMA VE 2.</i>
Cable Tray, Solid-bottom or Non-Ventilated	A fabricated structure consisting of a bottom without ventilation openings within integral or separate longitudinal side rails.	Vedi NEMA VE 2. <i>See NEMA VE 2.</i>
Cable Tray, Trough or Ventilated	A fabricated structure consisting of integral or separate longitudinal rails and a bottom having openings sufficient for the passage of air and utilizing 75% or less of the plan area of the surface to support cables where the maximum open spacings between cable support surfaces of transverse elements do not exceed 100 millimeter (mm) (4 inch (in)) in the direction parallel to the tray side rails.	Vedi NEMA VE 2. <i>See NEMA VE 2.</i>
Cable Tray, Wire Mesh	A manufactured wire mesh tray consisting of steel wires welded at all intersections. Longitudinal wires located on the exterior of the tray are spaced at a maximum of 50 mm (2 in), and transverse wires are spaced at a maximum of 100 mm (4 in).	Vedi NEMA VE 2. <i>See NEMA VE 2.</i>
Cartridge Fuses, Nonrenewable	This category covers nonrenewable cartridge-enclosed fuses, rated as follows: 250 V (0 - 600 A), 300 V (0 - 1200 A), 600 V (0 - 6000 A). The fuse classes are further categorized... These fuses are intended for use on ac circuits only, unless also marked with a dc voltage rating. These fuses are suitable for branch circuit, feeder and service overcurrent protection in accordance with ANSI/NFPA 70, "National Electrical Code". The term "current-limiting" indicates that a fuse, when tested on a circuit capable of delivering a specific short-circuit current (rms amps symmetrical) at rated voltage, will start to melt within 90 electrical degrees and will clear the circuit within 180 electrical degrees (1/2 cycle). Because the time required for a fuse to melt is dependent on the available current of the circuit, a fuse that may be current-limiting when subjected to a specific short-circuit current (rms amps symmetrical) may not be current-limiting on a circuit of lower maximum available current. Class K fuses incorporate dimensional features equivalent to, and are thus interchangeable with, Class H fuses. Class R fuses incorporate features that permit their insertion into Class H and K fuseholders. They are also provided with a feature that allows their insertion into rejection-type fuseholders designed to accept only Class RK1 or RK5 fuses. All classes covered under this category (with the exception of Class H) are further classified as to their maximum peak let-through current (IP) and maximum clearing ampere-squared seconds (I ² t) as follows. These tables indicate the maximum permissible let-through values obtained when the fuse is connected to a circuit capable of providing the indicated available current.	
CEC	Canadian Electrical Code	Codice elettrico Canadese riportante le norme di installazione <i>Canadian Electrical Code reporting the installation standards</i>

Sigla <i>Abbreviation</i>	Definizione <i>Defintion</i>	Note/osservazioni/descrizioni <i>Remarks/description</i>
CFR	Code of Federal Regulation	Codice civile Americano <i>American Civil Code</i>
cmil	Circular Mills	Il Circular Mil è l'unità di area usata specificatamente per definire la sezione circolare di un conduttore o di un cavo; è l'area equivalente di un cerchio il cui diametro è 0,001 pollici. Per convertire i Circular Mills in millimetri quadrati è necessario moltiplicare per $5,067 \cdot 10^{-4}$. <i>Circular Mil is the unit of area specifically used to define the circular section of a conductor or of a cable; it is the equivalent area of a circle with a diameter of 0,001 inches. To change the Circular Mills in square millimetres, multiply by $5,067 \cdot 10^{-4}$.</i>
Conduit Body	A separate portion of a conduit or tubing system that provides access through a removable cover(s) to the interior of the system at a junction of two or more sections of the system or at a terminal point of the system.	Vedi NEC. <i>See NEC.</i>
Control circuit	A circuit that carries the electric signals directing the performance of a controller, and which does not carry the main power circuit. A control circuit is, in most cases, limited to 15 amperes (rif. UL 508a).	
CPR	Canadian Standards Association	Istituto Canadese di normazione <i>Canadian Standards Institute</i>
CSA	Construction Product Regulation	Regolamento sui prodotti da costruzione
EMT	Electrical Metallic Tubing. An unthreaded thinwall raceway of circular cross section designed for the physical protection and routing of conductors and cables and for use as an equipment grounding conductor when installed utilizing appropriate fittings. EMT is generally made of steel (ferrous) with protective coatings or aluminum (nonferrous).	Vedi NEC. <i>See NEC.</i>
Enclosure	The case or housing of apparatus, or the fence or walls surrounding an installation to prevent personnel from accidentally contacting energized parts or to protect the equipment from physical damage.	Vedi NEC. <i>See NEC.</i>
Field wiring	Conductors to be installed by others to connect the industrial control panel to source(s) of supply, remote control devices, and loads (rif. UL 508a).	
Flexible Metal Conduit, Liquid-tight	This category covers liquid-tight flexible metal conduit in trade sizes 3/8 to 4 (metric designators 16 to 103) inclusive, for installation in accordance with Article 350 of ANSI/NFPA 70, "National Electrical Code" (NEC). Liquid-tight flexible metal conduit is intended for use with conductors in circuits of 600 V nominal or less. This product may also be used for installation of conductors in motor circuits, and for electric signs and outline lighting in accordance with the NEC.	
Flexible Nonmetallic Conduit, Liquid-tight	This category covers liquid-tight flexible nonmetallic conduit, in trade sizes 3/8 in. to 4 (metric designators 16 to 103) inclusive, for installation in accordance with Article 356 of ANSI/NFPA 70, "National Electrical Code" (NEC), for conductors in circuits of 600 V, nominal, or less. This product may also be used for installation of conductors for electric signs and outline lighting in accordance with the NEC.	
FMC	Flexible Metal Conduit. A raceway of circular cross section made of helically wound, formed, interlocked metal strip.	Vedi NEC. <i>See NEC.</i>
FMT	Flexible Metallic Tubing. A raceway that is circular in cross section, flexible, metallic, and liquidtight without a nonmetallic jacket.	Vedi NEC. <i>See NEC.</i>
FNMC	Liquid-tight Flexible Nonmetallic Conduit	È la sigla alternativa alla LFNC. <i>This is the alternative abbreviation of LFNC.</i>
Fuseholders, Cartridge Fuse	This category covers fuseholders intended for use with Class CC, G, H, J, K, R and T cartridge fuses. A Class CTL (current-limiting) cartridge fuseholders has the physical size, configuration or other means which, in conjunction with the physical means provided in a Class CTL assembly, is designed to prevent the installation of more fuseholder poles than the number for which the assembly is designed and rated. An interrupting rating on a fuseholder included in a piece of equipment does not automatically qualify the equipment in which the fuseholder is installed for use on circuits with higher available currents than the rating of the equipment itself.	
GFCI	Ground-Fault Circuit Interrupter. A device intended for the protection of personnel that functions to de-energize a circuit or portion thereof within an established of time when a current to ground exceeds the values established for a Class A device.	Vedi NEC. <i>See NEC.</i>
HAR	Harmonized Cordage	
Industrial control panel for general use	A control panel intended to be installed in accordance with the general use requirements in Chapter 4 of the National Electrical Code, ANSI/NFPA 70 (rif. UL 508a).	

Sigla Abbreviation	Definizione Defintion	Note/osservazioni/descrizioni Remarks/description
Industrial Control Panels - Component	This category covers the following component devices: - Incomplete electrical assemblies of industrial control equipment, including cabinet lighting accessories, cabinet heater accessories, ventilating fan accessories, controllers and interface connectors - Industrial control panel enclosures with standard equipment cutouts - Industrial control panel enclosure kits supplied as unassembled pieces Industrial control panel enclosure accessories, including louver kits, filter kits, observation window kits, hole seals, and gasket materials	
IMC	Intermediate Metal Conduit. A steel threadable raceway of circular cross section designed for the physical protection and routing of conductors and cables and for use as an equipment grounding conductor when installed with its integral or associated coupling and appropriate fittings.	Vedi NEC. See NEC.
ITC	Instrumentation Tray Cable	Vedi NEC. See NEC.
kcmil	Kilo Circular Mils	1 kcmil = 1000 cmil
LFMC	Liquidtight Flexible Metal Conduit. A raceway of circular cross section having an outer liquidtight, nonmetallic, sunlight-resistant jacket over an inner flexible metal core with associated couplings, connectors, and fittings for the installation of electric conductors.	Vedi NEC. See NEC.
LFNC	Liquid-tight Flexible Nonmetallic Conduit. A raceway of circular cross section of various types.	Vedi NEC. See NEC.
LFNC-A	Liquid-tight Flexible Nonmetallic Conduit - Type A. A smooth seamless inner core and cover bonded together and having one or more reinforcement layers between the core and covers.	
LFNC-B	Liquid-tight Flexible Nonmetallic Conduit - Type B. A smooth inner surface with integral reinforcement within the conduit wall.	
LFNC-C	Liquid-tight Flexible Nonmetallic Conduit - Type C. A corrugated internal and external surface without integral reinforcement within the conduit wall.	
MC	Metal Clad. Metal clad cable is a factory assembly of one or more insulated circuit conductors with or without optical fiber members enclosed in an armor of interlocking metal tape, or a smooth or corrugated metallic sheath	Vedi NEC. See NEC.
MC-HL	Metal Clad for Hazardous Locations	Vedi NEC. See NEC.
MCM	Thousands Circular Mils	MCM è una vecchia abbreviazione utilizzata per identificare 1000 Circular Mils, la sigla che si preferisce utilizzare oggi è kcmil. Quindi 300 MCM = 300 kcmil = 152 mm ² . MCM is an old abbreviation used to identify 1000 Circular Mils, today it is more used the abbreviation kcmil. So 300 MCM = 300 kcmil = 152 mm ² .
MTW	Machine Tool Wire, 90°C to 105°C, 600 volt rated thermoplastic insulated wire	
NEC	ANSI/NFPA 70 "National Electrical Code"	Codice elettrico Americano riportante le norme di installazione American Electrical Code reporting the installation standards
NEMA	National Electrical Manufactures Association	
NFPA	National Fire Protection Association	Vigili del fuoco Firemen
NRTL	National Recognized Testing Laboratory	Laboratori certificati per il rilascio delle certificazioni di prodotto Certified laboratories for the issue of product standards
OSHA	Occupational Safety and Health Associetion	Organismo federale di controllo per la sicurezza sui posti di lavoro Federal inspection body for working safety
Overcurrent protection	A device designed to open a circuit when the current through it exceeds a predetermined value. The ampere rating of the device is selected for a circuit to terminate a condition where the current exceeds the rating of conductors and equipment due to overloads, short circuits and faults to ground (rif. UL 508a).	
Overload protection	Protection required for motor circuits that will operate to prohibit excessive heating due to running overloads and failure to start (rif. UL 508a).	
PLTC	Power-limited Tray Cable	Vedi NEC. See NEC.
Power circuit	Conductors and components of branch and feeder circuits (rif. UL 508a).	
Raceway	An enclosed channel of metallic or nonmetallic materials designed expressly for holding wires, cables, or busbars.	Vedi NEC. See NEC.
RMC	Rigid Metal Conduit. A threadable raceway of circular cross section designed for the physical protection and routing of conductors and cables and for use as an equipment grounding conductor when installed with its integral or associated coupling and appropriate fittings.	Vedi NEC. See NEC.

Sigla Abbreviation	Definizione Defintion	Note/osservazioni/descrizioni Remarks/description
TC	Tray Cable. Power and control tray cable is a factory assembly of two or more insulated conductors, with or without associated bare or covered grounding conductors under a non-metallic sheath, for installation in cable tray, in raceways or where supported by a messenger wire.	Vedi NEC. See NEC.
TC-ER	Tray Cable – Exposed Run	Cavi TC rispondenti ai requisiti di resistenza all'impatto richiesti per i cavi Type MC. Questi cavi possono essere impiegati per le connessioni tra le canaline posa cavi (cable tray) e le apparecchiature senza l'impiego di condotti metallici di protezione (Metal Conduits) o cavi armati (Type MC). Sono cavi che possono essere utilizzati senza protezione. <i>TC cables in compliance with the necessary impact resistance requirements of Type MC cables. These cables can be employed for the connections between cable trays and equipment without using protective Metal Conduits or armored cables (Type MC). These cables can be used without protection.</i>
THHN	Indicates a single conductor having flame-retardant and heat-resistant thermoplastic insulation with a jacket of extruded nylon or equivalent material. The wire is rated 90°C dry only.	
THWN	Indicates a single conductor having flame-retardant, moisture- and heat-resistant thermoplastic insulation with a jacket of extruded nylon or equivalent material. The wire is rated 75°C wet or dry. THWN wire suitable for exposure to mineral oil and to liquid gasoline and gasoline vapors at ordinary ambient temperature is marked "Gasoline and Oil Resistant I" if suitable for exposure to mineral oil at 60°C, or "Gasoline and Oil Resistant II" if the compound is suitable for exposure to mineral oil at 75°C. Gasoline resistant wire has been tested at 23°C when immersed in gasoline. It is considered inherently resistant to gasoline vapors within the limits of the temperature rating.	
Tubing, Mechanical Protection – Component	This category covers tubing that may be used for the support, routing and mechanical protection of insulated wire. The tubing is intended to be used to interconnect separate component assemblies or consoles of electrical devices, such as medical or X-ray equipment. The mechanical protection afforded the internal wiring contained within the tubing is considered equivalent to the protection provided by a type SJT flexible cord.	
UL	Underwriters Laboratories	Laboratorio certificato per il rilascio delle certificazioni di prodotto <i>Certified Laboratory for the issue of product certifications</i>

Appendice S. Simboli e marchi

Appendix S. Symbols and marks

Simbolo Symbol	Sigla Abbreviation	Descrizione Description
	CANOPEN	CANopen is a communication protocol and device profile specification for embedded systems used in automation
	CSA	Canadian Standards Association - Canada
	DESINA	DistributEd and Standardised INstAllation technology for machine tools and manufacturing systems
<i>DeviceNet™</i>	DEVICENET	DeviceNet is a network system used in the automation industry to interconnect control devices for data exchange
	ETHERNET	Ethernet is a family of computer networking technologies for local area networks (LANs)
	PROFIBUS	PROFIBUS (Process Field Bus) is a standard for field bus communication in automation technology
	PROFINET	PROFINET is the open industrial Ethernet standard of PROFIBUS & PROFINET International (PI) for automation.
	RoHS	Restriction of Hazardous Substances Directive - Europe
	UL	UL Listed - Underwriters Laboratories - USA
	UR	UL Recognized - Underwriters Laboratories - USA
	EAC	Eurasian Conformity Mark - Russia, Belarus, Kazakhstan
	EHEDG	European Hygienic Engineering & Design Group - Europe
	CPR	Construction Product Regulation - Europe
	CE	The letters CE mean that the manufacturer or importer affirms the goods' conformity with European health, safety, and environmental protection standards. It is not a quality indicator or a certification mark.
	UKCA	UK Conformity Assessed marking is a conformity mark that indicates conformity with the applicable requirements for products sold within Great Britain.

Appendice T. Unità di misura

Appendix T. Measurement units

Tabella T.1. Lunghezze

Table T.1. Lengths

metro - meter	m	1 m = 0,001 km = 39,37 in = 3,28 ft = 1,09 yd
centimetro - centimetre	cm	1 cm = 0,01 m = 0,3937 in = 0,0328 ft = 0,0109 yd
chilometro - kilometre	km	1 km = 1000 m = 1093,61 yd = 0,5396 naut mi = 0,62137 mi
pollice - inch	1", in	1 in = 0,0833 ft = 0,0278 yd = 2,54 cm = 0,0254 m
piede - foot	1', ft	1 ft = 12 in = 0,333 yd = 30,48 cm = 0,3048 m
iarda - yard	yd	1 yd = 3 ft = 36 in = 91,44 cm = 0,9144 m
miglio marino - nautical mile	naut mi	1 naut mi = 1,853 km = 1853,18 m = 2026,67 yd = 1,151 mi
miglio terrestre US - mile	mi	1 mi = 1,609 km = 1609,35 m = 1760 yd = 0,868 naut mi
palmo - hand	hand	1 hand = 4 in = 0,3332 ft = 0,111 yd = 10,16 cm = 0,1016 m
spanna - span	span	1 span = 9 in = 0,7497 ft = 0,25 yd = 22,86 cm = 0,2286 m

Tabella T.2. Superficie

Table T.2. Surface

metro quadrato square meter	m ²	1 m ² = 10000 cm ² = 0,0001 ha = 1550 in ² = 10,76 ft ² = 1,196 yd ²
centimetro quadrato square centimetre	cm ²	1 cm ² = 0,0001 m ² = 0,155 in ² = 0,0011 ft ² = 0,00012 yd ²
chilometro quadrato square kilometre	km ²	1 km ² = 1000000 m ² = 100 ha = 0,386 mi ² = 247,105 ac
ara - are	a	1 a = 100 m ² = 0,01 ha = 1076,39 ft ² = 119,599 yd ² = 0,0000386 mi ² = 0,024 ac
ettaro - hectare	ha	1 ha = 100 a = 10000 m ² = 0,01 km ² = 107639,1 ft ² = 0,0039 mi ² = 2,47 ac
pollice quadrato - square inch	in ²	1 in ² = 0,00694 ft ² = 6,4516 cm ²
piede quadrato - square foot	ft ²	1 ft ² = 0,092 m ² = 144 in ² = 0,111 yd ²
iarda quadrata - square yard	yd ²	1 yd ² = 0,836 m ² = 8361,27 cm ² = 9 ft ² = 1296 in ² = 0,0002 ac
miglio quadrato - square mile	mi ²	1 mi ² = 2,59 km ² = 259 ha = 640 ac
acro - acre	ac	1 ac = 4046,86 m ² = 0,0040 km ² = 0,40 ha = 40,47 a = 43.560 ft ² = 4840 yd ² = 0,00156 mi ²

Tabella T.3. Volume

Table T.3. Volume

metro cubo - cubic meter	m ³	1 m ³ = 1000 dm ³ = 35,3146 ft ³ = 61023,744 in ³ = 1,308 yd ³ = 264,20 galUS = 219,97 galUK
decimetro cubo; litro cubic decimetre; litre	dm ³	1 dm ³ = 1 l = 0,001 m ³ = 61,024 in ³ = 0,0353 ft ³ = 0,00131 yd ³ = 0,26417 galUS = 0,21997 galUK
centimetro cubo cubic centimetre	cm ³ , cc	1 cm ³ = 0,001 dm ³ = 0,001 l = 0,061 in ³ = 0,000264 galUS = 0,00022 galUK
pollice al cubo - cubic inch	in ³	1 in ³ = 0,0000164 m ³ = 0,0164 dm ³ = 0,0005787 ft ³ = 0,0043 galUS = 0,0036 galUK
piede al cubo - cubic foot	ft ³	1 ft ³ = 0,02832 m ³ = 28,32 dm ³ = 1728 in ³ = 0,037 yd ³ = 7,48 galUS = 6,23 galUK
iarda al cubo - cubic yard	yd ³	1 yd ³ = 0,764 m ³ = 764,55 dm ³ = 46656 in ³ = 27 ft ³ = 201,97 galUS = 168,18 galUK
gallone americano - gallon US	galUS	1 galUS = 0,00378 m ³ = 3,785 dm ³ = 231 in ³ = 0,134 ft ³ = 0,0049 yd ³ = 0,833 galUK
gallone inglese - gallon UK	galUK	1 galUK = 0,00455 m ³ = 4,546 dm ³ = 277,42 in ³ = 0,16 ft ³ = 0,0059 yd ³ = 1,2 galUS

Tabella T.4. Pressione

Table T.4. Pressure

pascal	Pa	1 Pa = 1 N/m ² , 1 kPa = 0,01 bar = 0,1 N/cm ² = 0,10 mH ₂ O = 7,5 mmHg = 0,0099 atm = 0,145 psi = 0,02088 lbf/ft ² = 0,334 ftH ₂ O
bar	bar	1 bar = 100000 Pa = 100 kPa = 1,0197 kg/cm ² = 10,198 mH ₂ O = 750 mmHg = 0,987 atm = 14,5 psi = 33,455 ftH ₂ O
millibar	mbar	1 mbar = 100 Pa = 0,010 mH ₂ O = 0,750 mmHg = 0,00102 kg/cm ² = 0,0145 psi = 2,088 lbf/ft ² = 0,033 ftH ₂ O
millimetri di mercurio millimetres of mercury	mmHg	1 mmHg = 133,322 Pa = 0,133 kPa = 0,00133 bar = 0,0136 mH ₂ O = 0,00131 atm = 0,00136 kg/cm ² = 0,01934 psi = 2,78 lbf/ft ² = 0,045 ftH ₂ O
atmosfera tecnica = kgf/cm ² technical atmosphere = kgf/cm ²	at, kg/cm ²	1 at = 1 kg/cm ² = 735,56 mmHg = 10 mH ₂ O = 98066,50 Pa = 98,067 kPa = 0,981 bar = 0,968 atm = 14,22 psi = 2048,16 lbf/ft ² = 32,81 ftH ₂ O
atmosfera metrica metric atmosphere	atm	1 atm = 101325 Pa = 760 mmHg = 1,033 at = 10,33 mH ₂ O = 1,01 bar = 14,696 psi = 2116,22 lbf/ft ² = 33,9 ftH ₂ O
metri colonna d'acqua meters column of water	mH ₂ O	1 mH ₂ O = 9806 Pa = 0,09806 bar = 73,55 mmHg = 0,9806 N/cm ² = 0,09678 atm = 0,0999 at = 1,4224 psi = 204,8 lbf/ft ² = 3,28 ftH ₂ O

piedi di colonna d'acqua <i>foot of water</i>	ftH ₂ O	1 ftH ₂ O = 2988,87 Pa = 0,0299 bar = 0,3048 mH ₂ O = 22,419 mmHg = 0,0295 atm = 0,03048 kg/cm ² = 0,4335 psi = 62,42 lbf/ft ²
pounds per pollice quadrato <i>pounds per square inch</i>	psi	1 psi = 6894,76 Pa = 6,894 kPa = 0,069 bar = 0,703 mH ₂ O = 51,715 mmHg = 0,689 N/cm ² = 0,068 atm = 0,0703 kg/cm ² = 144 lbf/ft ² = 2,31 ftH ₂ O
pounds per piede quadrato <i>pounds per square foot</i>	lbf/ft ²	1 lbf/ft ² = 2988,87 Pa = 2,99 kPa = 0,0299 bar = 0,3048 mH ₂ O = 22,418 mmHg = 0,299 N/cm ² = 0,0295 atm = 0,0305 at = 0,433 psi = 62,424 lbf/ft ²

Tabella T.5. Portata in volume

Table T.5. Capacity and volume

metri cubi al secondo <i>cubic meters per second</i>	m ³ /s	1 m ³ /s = 60 m ³ /min = 3600 m ³ /ora = 1000 l/s = 60000 l/min = 6102374,42 in ³ /s = 2118,88 ft ³ /min = 15850,32 gpm = 13198,13 l gpm
metri cubi al minuto <i>cubic meters per minute</i>	m ³ /min	1 m ³ /min = 0,0167 m ³ /s = 60 m ³ /h = 16,67 l/s = 1000 l/min = 35,31 ft ³ /min = 264,17 gpm = 219,97 l gpm
metro cubo all'ora <i>cubic meters per hour</i>	m ³ /h	1 m ³ /h = 0,000278 m ³ /s = 0,0167 m ³ /min = 0,28 l/s = 16,67 l/min = 1017,06 in ³ /min = 0,588 ft ³ /min = 4,40 gpm = 3,66 l gpm
litri al secondo <i>litres per second</i>	l/s	1 l/s = 0,001 m ³ /s = 0,06 m ³ /min = 3,6 m ³ /h = 60 l/min = 3661,42 in ³ /min = 2,12 ft ³ /min = 15,85 gpm = 13,198 l gpm
litri al minuto <i>litres per minute</i>	l/min	1 l/min = 0,001 m ³ /min = 0,06 m ³ /h = 0,0167 l/s = 61,024 in ³ /min = 0,035 ft ³ /min = 0,264 gpm = 0,22 l gpm
pollice cubo al minuto <i>cubic inch per minute</i>	in ³ /min	1 in ³ /min = 0,00027 l/s = 0,016 l/min = 0,00058 ft ³ /min = 0,0043 gpm = 0,0036 l gpm
piede cubo al minuto <i>cubic foot per minute</i>	ft ³ /min	1 ft ³ /min = 0,00047 m ³ /s = 0,028 m ³ /min = 1,7 m ³ /h = 0,472 l/s = 28,32 l/min = 1728 in ³ /min = 7,48 gpm = 6,23 l gpm
gallone al minuto <i>gallon per minute</i>	gpm	1 gpm = 0,0038 m ³ /min = 0,227 m ³ /h = 0,063 l/s = 3,785 l/min = 231 in ³ /min = 0,134 ft ³ /min = 0,833 l gpm
gallone imperiale al minuto <i>imperial gallon per minute</i>	l gpm	1 l gpm = 0,000076 m ³ /s = 0,00454 m ³ /min = 0,273 m ³ /h = 0,076 l/s = 4,55 l/min = 277,42 in ³ /min = 0,16 ft ³ /min = 1,2 gpm

Tabella T.6. Velocità

Table T.6. Speed

metri al secondo <i>meters per second</i>	m/s	1 m/s = 60 m/min = 3,6 km/h = 39,37 in/s = 2362,2 in/min = 3,28 ft/s = 196,85 ft/min = 2,237 mi/h = 1,94 kn
kilometri all'ora <i>kilometres per hour</i>	km/h	1 km/h = 0,278 m/s = 16,67 m/min = 10,963 in/s = 656,17 in/min = 0,91 ft/s = 54,68 ft/min = 0,62 mi/h = 0,54 kn
metri al minuto <i>meters per minute</i>	m/min	1 m/min = 0,0167 m/s = 0,06 km/h = 0,66 in/s = 39,37 in/min = 0,0547 ft/s = 3,28 ft/min = 196,85 ft/h = 0,037 mi/h = 0,032 kn
pollice al secondo <i>inch per second</i>	in/s	1 in/s = 0,0254 m/s = 1,524 m/min = 0,091 km/h = 60 in/min = 0,083 ft/s = 5 ft/min = 300 ft/h = 0,057 mi/h = 0,049 kn
pollice al minuto <i>inch per minute</i>	in/min	1 in/min = 0,0254 m/min = 0,001524 km/h = 0,167 in/s = 0,0014 ft/s = 0,083 ft/min = 5 ft/h
piedi al secondo <i>foot per second</i>	ft/s	1 ft/s = 0,305 m/s = 18,288 m/min = 1,097 km/h = 12 in/s = 720 in/min = 60 ft/min = 0,68 mi/h = 0,59 kn
piedi al minuto <i>foot per minute</i>	ft/min	1 ft/min = 0,00508 m/s = 0,3048 m/min = 0,0183 km/h = 0,2 in/s = 12 in/min = 0,0167 ft/s = 60 ft/h = 0,011 mi/h = 0,0099 kn
piedi per ora <i>foot per hour</i>	ft/h	1 ft/h = 0,005 m/min = 0,0033 in/s = 0,2 in/min = 0,0167 ft/min
miglia all'ora <i>mile per hour</i>	mi/h	1 mi/h = 0,447 m/s = 26,82 m/min = 1,609 km/h = 17,6 in/s = 1056 in/min = 1,47 ft/s = 88 ft/min = 0,87 kn
miglia nautiche per ora = nodo <i>nautical mile per hour = knot</i>	kn	1 kn = 0,51 m/s = 30,89 m/min = 1,85 km/h = 20,27 in/s = 1216 in/min = 1,69 ft/s = 101,33 ft/min = 1,15 mi/h

Tabella T.7. Velocità angolare

Table T.7. Angular velocity

radianti al secondo <i>radiant per second</i>	rad/s	1 rad/s = 60 rad/min = 0,159 giri/s = 9,55 giri/min
radianti al minuto <i>radiant per minute</i>	rad/min	1 rad/min = 0,0167 rad/s = 0,0026 giri/s = 0,159 giri/min
giri al secondo <i>revolutions per second</i>	giri/s	1 giro/s = 60 giri/min = 6,283 rad/s = 376,99 rad/min
giri al minuto <i>revolutions per minute</i>	giri/min	1 giro/min = 0,0167 giri/s = 0,1047 rad/s = 6,283 rad/min

Tabella T.8. Accelerazione

Table T.8. Acceleration

metro al secondo quadrato <i>meter per square second</i>	m/s ²	1 m/s ² = 100 cm/s ² = 0,001 km/s ² = 3,28 ft/s ² = 39,37 in/s ² = 0,00062 mi/s ²
centimetro al secondo quadrato <i>centimetre per square second</i>	cm/s ²	1 cm/s ² = 0,01 m/s ² = 0,00001 km/s ² = 0,0328 ft/s ² = 0,394 in/s ²
kilometro al secondo quadrato <i>kilometre per square second</i>	km/s ²	1 km/s ² = 1000 m/s ² = 100000 cm/s ² = 3280,84 ft/s ² = 39370,08 in/s ² = 0,621 mi/s ²
piedi al secondo quadrato <i>foot per square second</i>	ft/s ²	1 ft/s ² = 0,3048 m/s ² = 30,48 cm/s ² = 12 in/s ²
pollici al secondo quadrato <i>inch per square second</i>	in/s ²	1 in/s ² = 0,0254 m/s ² = 2,54 cm/s ² = 0,083 ft/s ²
miglia al secondo quadrato <i>mile per square second</i>	mi/s ²	1 mi/s ² = 1609,34 m/s ² = 1,609 km/s ² = 5280 ft/s ² = 63360 in/s ²

Tabella T.9. Forza - Peso

Table T.9. Force - Weight

Newton	N	1 N = 0,102 kgf = 0,0001 t = 0,2248 lbf = 3,597 ozf
kilogrammo forza; kilogrammo peso <i>kilogram force; kilogram weight</i>	kgf; kgp	1 kgf = 9,81 N = 0,001 t = 2,204 lbf = 35,27 ozf
tonnellata peso - <i>ton weight</i>	t	1 t = 9'806,65 N = 1'000 kgf = 2'204,62 lbf = 35'274 ozf
kilopound	kp	1 kp = 4'448 N = 453,59 kgf = 1'000 lbf = 16'000 ozf
libbra - <i>pound force</i>	lbf	1 lbf = 4,448 N = 0,454 kgf = 16 ozf
oncia - <i>ounce force</i>	ozf	1 ozf = 0,278 N = 0,028kgf = 0,0625 lbf
libbra al piede - <i>pound feet</i>	lbf/ft	1 lbf/ft = 1,4881 kg/m

Tabella T.10. Potenza

Table T.10. Power

kilowatt	kW	1 kW = 1,36 CV = 1,34 hp = 737,56 lbf-ft/s = 44253,7 lbf-ft/min = 859,84 kcal/h = 3412,14 btu/h = 101,97 kgf-m/s
cavallo vapore <i>horsepower</i>	CV	1 CV = 0,735 kW = 0,986 hp = 75 kg-m/s = 542,47 lbf-ft/s = 632,41 kcal/h = 2509,62 btu/h = 75 kgf-m/s
kilogrammo forza per metri al secondo <i>kilogram force per meter per second</i>	kgf · m/s	1 kgf-m/s = 0,01 kW = 0,013 CV = 0,013 hp = 7,23 lbf-ft/s = 433,98 lbf-ft/min = 8,43 kcal/h = 33,46 btu/h
kilocaloria all'ora <i>kilogram calorie per hour</i>	kcal/h	1 kcal/h = 0,0012 kW = 0,0016 CV = 0,00156 hp = 0,8578 lbf-ft/s = 51,47 lbf-ft/min = 3,97 btu/h = 0,12 kgf-m/s
cavallo vapore <i>horsepower</i>	HP	1 HP = 1,014 CV = 0,746 kW = 550 lbf-ft/s = 33000 lbf-ft/min = 641,19 kcal/h = 2544,43 btu/h = 76,04 kgf-m/s
piedi libbre al secondo <i>foot pound force per second</i>	lbf · ft/s	1 lbf-ft/s = 0,0013 kW = 0,0018 CV = 0,0018 hp = 60 lbf-ft/min = 1,166 kcal/h = 4,63 btu/h = 0,138 kgf-m/s
piedi libbre al minuto <i>foot pound force per minute</i>	lbf · ft/min	1 lbf-ft/min = 0,000023 kW = 0,0167 lbf-ft/s = 0,019 kcal/h = 0,077 btu/h = 0,0023 kgf-m/s
unità termica britannica all'ora <i>british thermal unit per hour</i>	BTU/h	1 btu/h = 0,00029 kW = 0,216 lbf-ft/s = 12,97 lbf-ft/min = 0,25 kcal/h = 0,030 kgf-m/s

Tabella T.11. Lavoro - Energia - Momento - Coppia - Calore
Table T.11. Work - Energy - Moment - Torque - Heat

joule	J	1 J = 1N·m = 0,102 kgf·m = 0,00024 kcal = 8,85 lbf·in = 0,74 lbf·ft = 0,00095 BTU
kilogrammo forza per metro <i>kilogram force per meter</i>	kgf·m	1 kgf·m = 9,807 J = 0,0023 kcal = 86,80 lbf·in = 7,233 lbf·ft = 0,0093 BTU
cavallo vapore per ora <i>horsepower per hour</i>	CV·h	1 CV·h = 270000 kgf·m = 0,736 kW·h = 632,41 kcal = 2509 BTU
kilocaloria - <i>kilogram calorie</i>	kcal	1 kcal = 4,1868 kJ = 426,93 kgf·m = 0,0016 CV·h = 0,0012 kW·h = 37056,3 lbf·in = 3088 lbf·ft = 3,97 BTU
kilowatt per ora - <i>kilowatt per hour</i>	kW·h	1 kW·h = 3600 kJ = 1,36 CV·h = 859,8 kcal = 3412,14 BTU
libbre per pollice <i>pound force inch</i>	lbf·in	1 lbf·in = 0,113 J = 0,0115 kgf·m = 0,083 lbf·ft = 0,0001 BTU
libbre per piede <i>pound force foot</i>	lbf·ft	1 lbf·ft = 1,356 J = 0,138 kgf·m = 0,324 cal = 12 lbf·in = 0,0013 BTU
cavalli vapore per ora <i>horse power hour</i>	HP·h	1 HPh = 2,684 MJ = 641,19 kcal = 1,014 CV·h = 0,746 kW·h = 1980000 lbf·ft = 2544,43 BTU
unità termica britannica <i>british thermal unit</i>	BTU	1 BTU = 1055,056 J = 107,58 kgf·m = 0,0004 CV·h = 0,252 kcal = 0,00029 kWh = 9338,03 lbf·in = 778,17 lbf·ft

Tabella T.12. Densità
Table T.12. Density

kilogrammo su metro cubo <i>kilogram per cubic meter</i>	kg/m ³	1 kg/m ³ = 0,001 kg/dm ³ = 0,001 t/m ³ = 0,001 g/cm ³ = 0,062 lb/ft ³ = 0,00075 tn/yd ³ = 0,00084 s tn/yd ³ = 0,133 oz/gal
kilogrammo su decimetro cubo <i>kilogram per cubic decimetre</i>	kg/dm ³	1 kg/dm ³ = 1000 kg/m ³ = 0,001 g/cm ³ = 1 t/m ³ = 1 g/cm ³ = 62,42 lb/ft ³ = 0,036 lb/in ³ = 133,53 oz/gal
tonnellata su metro cubo <i>ton per cubic meter</i>	t/m ³	1 t/m ³ = 1000 kg/m ³ = 1 kg/dm ³ = 0,001 kg/cm ³ = 1 g/cm ³ = 62,43 lb/ft ³ = 0,036 lb/in ³ = 0,752 tn/yd ³ = 0,843 s tn/yd ³ = 133,53 oz/gal
libbre su piedi al cubo <i>pound per cubic foot</i>	lb/ft ³	1 lb/ft ³ = 16,018 kg/m ³ = 0,016 kg/dm ³ = 0,016 t/m ³ = 0,016 g/cm ³ = 0,00058 lb/in ³ = 0,012 tn/yd ³ = 0,0135 s tn/yd ³ = 2,14 oz/gal
libbre su pollici al cubo <i>pound per cubic inch</i>	lb/in ³	1 lb/in ³ = 27,68 kg/dm ³ = 0,02768 kg/cm ³ = 27,68 t/m ³ = 27,68 g/cm ³ = 1728 lb/ft ³ = 20,83 tn/yd ³ = 23,33 s tn/yd ³ = 3696 oz/gal
once su gallone <i>ounce per gallon</i>	oz/gal	1 oz/gal = 7,489 kg/m ³ = 0,00749 kg/dm ³ = 0,00749 t/m ³ = 0,00749 g/cm ³ = 0,467 lb/ft ³ = 0,00027 lb/in ³ = 0,00563 tn/yd ³ = 0,0063 oz/gal

Tabella T.13. Temperatura
Table T.13. Temperature

Kelvin	K	$K = ^\circ C + 273,15$, $K = 1,8 \cdot ^\circ R$, $K = (5/9) \cdot ^\circ F + (459,67/1,8)$
grado centigrado <i>Centigrade degree</i>	$^\circ C$	$^\circ C = (^\circ F - 32) \cdot 5/9$, $^\circ C = K - 273,15$ $^\circ C = (5/9) \cdot ^\circ F - (32/1,8)$
grado Fahrenheit <i>Fahrenheit degree</i>	$^\circ F$	$^\circ F = 9/5 \cdot ^\circ C + 32$, $^\circ F = ^\circ R - 459,67$ $^\circ F = (9/5) \cdot K - 459,67$
grado Rankine <i>Rankine degree</i>	$^\circ R$	$^\circ R = (5/9) K$, $^\circ R = 491,67 + (9/5) \cdot ^\circ C$, $^\circ R = 459,67 + ^\circ F$

Si suggerisce di verificare l'esistenza di versioni più aggiornate del presente documento visitando la sezione download del nostro sito web.
We suggest to check for newer versions of this document visiting the download page of our web site.



www.tekima.com/cataloghi-e-brochure/



www.tekima.com/en/catalogues-and-brochure/

Questo documento ha lo scopo di presentare l'intera gamma di prodotti destinati al mercato dell'automazione industriale e di fornire informazioni tecniche generali che non devono essere intese come esaustive degli argomenti trattati. Ogni scelta che può influenzare il buon funzionamento di una apparecchiatura, una macchina o un impianto deve essere presa consultando personale tecnico qualificato.

Tekima S.r.l. non garantisce della completezza, dell'aggiornamento e dell'accuratezza dei dati contenuti in questo documento e che possono essere soggetti a modifica o cancellazione in qualsiasi momento e senza alcun preavviso.

Tekima S.r.l. non si assume nessuna responsabilità in caso di danni diretti o indiretti a persone o cose o perdita di profitto dovuto ad un uso improprio o in caso di inosservanza delle raccomandazioni e dei limiti di impiego del prodotto.

I contenuti estratti dalle normative ANSI/NFPA sono di proprietà esclusiva della National Fire Protection Association.

I contenuti estratti dalle normative UL sono di proprietà esclusiva di Underwriter's Laboratories Inc.

I marchi "Tekima", "ANSI", "UL Listed", "UL Recognized", "CSA", "ETL", "Intertek", "Desina", "ProfiBus", "ProfiNet", "DeviceNet", "CanOpen", "DRIVE CLIQ", "SINAMICS" sono marchi registrati.

Le marcature e le immagini dei cavi sono puramente indicative.

Tutti i diritti sono riservati. Nessuna parte di questa pubblicazione può essere riprodotta senza il consenso scritto della Società Tekima S.r.l.

The aim of this document is to introduce the whole product range destined to the industrial automation market, and to give general technical information which have not to be considered as exhaustive of the topics discussed. Any choice which could affect the good operation of equipment, machines or systems, has to be made by seeking the advice of qualified technicians.

Tekima S.r.l. does not guarantee the completeness, updating and accuracy of the data contained in this document, which could be subject to amendment or cancellation in any moment and without advice.

Tekima S.r.l. cannot be held responsible either in case of direct and indirect injuries or damages to property, or in case of profit loss due to an improper use of the product or non-observance of recommendations and use limitations.

The extracts from ANSI/NFPA standards are exclusive property of National Fire Protection Association.

The extracts from UL standards are exclusive property of Underwriter's Laboratories Inc.

"Tekima", "ANSI", "UL Listed", "UL Recognized", "CSA", "ETL", "Intertek", "Desina", "ProfiBus", "ProfiNet", "DeviceNet", "CanOpen", "DRIVE CLIQ", "SINAMICS" marks are registered trademarks.

The markings and the images of the cables are indicative.

All rights reserved. Reproduction or copying of any part of this publication is strictly forbidden without the written consent of Tekima S.r.l.

Tekima: Cavi industriali

Tekima: Industrial cables

Art Direction e realizzazione: IDEAgency (BS)



Headquarters

Tekima S.r.l.
Via Carlo Signaroli, 3
25010 Borgosatollo
Brescia - Italia

APAC Branch

Tekima Asia Pacific Pte. Ltd.
30 Cecil Street
#19-08 Prudential Tower
049712 Singapore

USA Branch

Tekima North America, Inc.
522 Springfield St
Dayton
Ohio 45403

www.tekima.com



tekima.com/IT



tekima.com/EN



tekima.com/DE